

97050681
Rev.006
2017. 03



FULL TOUCH

SKEMA 6 - SKEMA 8

EN



TABLE OF CONTENTS

1.	Safety guidelines	4	5.5.3.	IMPLANT operating mode.....	51
1.1.	Symbol definition.....	4	5.5.4.	Reduction ratio setting menu.....	52
1.2.	Intended use.....	4	5.5.5.	RECIPROCATING operating mode.....	53
1.2.1.	Classification and reference standards	4	5.6.	Scaler	54
1.2.2.	Environmental conditions	5	5.6.1.	SURGISON 2 surgical detartarer device.....	56
1.2.2.1.	Transport and packaging conditions	5	5.6.1.1.	NORMAL operational mode	58
1.2.3.	Warranty.....	5	5.6.1.2.	BOOST functioning mode	58
1.2.4.	Disposing the equipment when no longer used	5	5.7.	T LED curing light.....	59
1.3.	Safety rules	5	5.8.	C-U2 and C-U2 PRO intraoral camera system	62
1.4.	Cleaning and disinfecting	7	5.9.	Peristaltic pump.....	67
2.	Description of the equipment.....	8	5.10.	Electronic apex locator (LAEC).....	68
2.1.	Nameplate	8	5.11.	ZEN-XI INTEGRATED SENSOR	70
2.2.	Dental units	8	6.	Assistant's board operation	71
2.3.	Dental chair	10	6.1.	Assistant's touchpad	71
3.	Turning on the dental operatory.....	11	6.2.	Instruments on assistant's board.....	72
4.	Dental chair operation	11	6.3.	Suction tubes.....	72
4.1.	Safety devices	12	6.4.	Instrument tray.....	73
4.2.	Emergency devices	12	6.5.	Hydraulic saliva ejector	73
4.3.	Adjustable headrest.....	13	7.	Hydrogroup operation.....	74
4.4.	Adjustable armrest (optional)	13	7.1.	Fill cup and bowl.....	74
5.	Instrument board operation.....	14	7.2.	S.S.S. System	75
5.1.	Doctor's control console.....	16	7.2.1.	Manual disinfection cycle with SSS system	76
5.1.1.	User interface	18	7.3.	M.W.B. system	77
5.1.1.1.	Operator selection.....	19	7.4.	AUTOSTERIL automatic disinfection system.....	78
5.1.1.2.	General settings	19	7.5.	TIME FLUSHING automatic cycle	80
5.1.1.2.1.	AUTOSTERIL disinfection cycle setting	20	7.6.	S.H.D. system for flushing the suction tubes.....	81
5.1.1.2.2.	TIME FLUSHING CYCLE SETTING	21	7.7.	Opening/closing the cover at the side of the hydrogroup... 82	
5.1.1.2.3.	M.W.B. system tank emptying	21	8.	Accessories.....	83
5.1.1.2.4.	Bowl water delivery setting.....	22	8.1.	Operating lamp	83
5.1.1.2.5.	Cup water delivery setting	23	8.2.	Monitor on lamp pole.....	83
5.1.1.2.6.	Automatic bowl movement setting.....	23	8.3.	Negatoscope for panoramas.....	83
5.1.1.2.7.	Foot control adjustment.....	24	8.4.	Air/water/230V quick-connect couplers	83
5.1.1.2.8.	Operating lamp adjustment	24	8.5.	H.P.A. filter (High Protected Air)	84
5.1.1.2.9.	Other Settings	25	9.	Maintenance	85
5.1.1.2.10.	Time and date setting	25	9.1.	Instrument maintenance.....	85
5.1.1.2.11.	Chronometer	26	9.2.	Draining condensate	85
5.1.1.2.12.	Personalization of favourite keys	26	9.3.	Cleaning the surgical suction filter.....	85
5.1.1.2.13.	Operator data entry	27	9.4.	Surgical suction	86
5.1.1.2.14.	LANGUAGE selection.....	27	9.5.	CATTANI surgical separator.....	87
5.1.1.2.15.	LAEC setting	27	9.6.	Cleaning the turbine return air filter.....	88
5.1.1.2.16.	USB SETUP.....	28	9.7.	METASYS amalgam separator	88
5.1.1.2.17.	Image management	28	9.8.	DÜRR amalgam separator	88
5.1.1.2.17.1.	Image management through iRYS.....	29	9.9.	Dental chair	88
5.1.2.	Setting the dental chair's "rinse" and "home" positions	31	10.	Fault messages.....	89
5.1.3.	Programming the chair positions 1, 2, 3 and 4.....	31	11.	Specifications	90
5.1.4.	Emergency stop button	32	11.1.	SKEMA 6 dimensional characteristics	91
5.1.5.	Button to reduce the operating lamp brightness.....	32	11.2.	Overall dimensions SKEMA 6 CP	92
5.1.6.	TOUCH screen disable button	32	11.3.	Overall dimensions SKEMA 8 RS	93
5.2.	Foot control	33	11.4.	Overall dimensions SKEMA 8 CP	94
5.2.1.	"Multifunction" foot control.....	33	12.	Dental operatory maintenance plan.....	95
5.2.2.	"Push-pedal" foot control.....	35			
5.2.3.	"Power Pedal" foot control.....	37			
5.2.4.	"Lateral excursion" foot control.....	38			
5.2.5.	Wireless foot control.....	40			
5.3.	Syringe	42			
5.4.	Turbine	43			
5.5.	Micromotor	45			
5.5.1.	RESTORATIVE operating mode	48			
5.5.2.	ENDODONTIC operating mode	48			
5.5.2.1.	Endocanal drill customisation menu.....	50			



1. Safety guidelines

- These instructions explain how to correctly use the following dental units:

SKEMA 6, SKEMA 6 CP, SKEMA 8 RS, SKEMA 8 CP

Carefully read and become familiar with the content of this manual before using the equipment.

- The dental units described in this manual are manufactured by CEFLA s.c. - via Selice Prov.le 23/A - 40026 Imola (BO) Italy, a manufacturer complying with the European Directive on devices.
- These instructions describe all the versions of the operating units with the maximum possible accessories, therefore not all the paragraphs are applicable to the unit you have purchased.
- No part of this manual is to be reproduced, stored in a retrieval system or transmitted in any form or by any means, i.e. electronic, mechanical, photocopying, translation or otherwise, without the prior written permission of CEFLA s.c.
- The information, specifications and illustrations contained in this publication are not binding. CEFLA s.c. reserves the right to make technical improvements and changes without modifying the instructions contained herein.
- The manufacturer has a company policy of continual development. Although every effort is made to keep technical documentation up-to-date at all times the manual may not correspond exactly to current specifications. The manufacturer reserves the right to make changes without prior notice.
- The original version of this manual is written in Italian.
- This equipment is equipped with a device that prevents liquid back up.
- The manufacturer's website contains a list of authorised agents of the various countries.

1.1. Symbol definition

List of symbols used in this document to denote certain conditions:

- 1) Type of protection against direct and indirect contact: **Class I**.
Type of protection against direct and indirect contact: **Type B**.
- 2) **WARNING!**
Failure to observe may result in equipment damage or injury to the user and/or patient.
- 3) **OPERATING INSTRUCTIONS:**
This symbol indicates that the user should read and become familiar with the content of the User's manual before attempting to use the relative part of the equipment.
- 4) **NOTE:**
Identifies information that is especially important for the user and/or assistant.
- 5) Earth ground. Functional earth connection.
- 6) Alternating current
- 7) Part sterilised in a steam autoclave up to 135° C.
- 8) ON / OFF button.
- 9) "Refer to the instruction manual".
Means that for reasons of safety you need to consult the instruction manual before using the device.
- 10) On (a part of the apparatus)
- 11) Off (a part of the apparatus)
- 12) Equipment in accordance with essential requirements of directive EEC 93/42 and subsequent changes (Class II equipment).
Notified body: IMQ spa.
- 13) Equipment in accordance with essential requirements of directive EEC 93/42 and subsequent changes .
- 14) Waste disposal symbol in accordance with Directive 2012/19/EU.
- 15) "Warning biological hazard".
It provides information about possible risks of contamination deriving from contact with fluids, storage of infected biological waste.
- 16) Manufacturer
- 17) Month and year of constructions
- 18) Apparatus serial number
- 19) DVGW mark (quality assurance kitemark regarding supply of drinking water).
- 20) Product/equipment identification code.
- 21) Do not push.
- 22) Foot crushing hazard.
- 23) Device equivalent to Class 2 light source.
- 24) Hand crushing hazard.
- 25) Ukrainian national symbol of conformity.

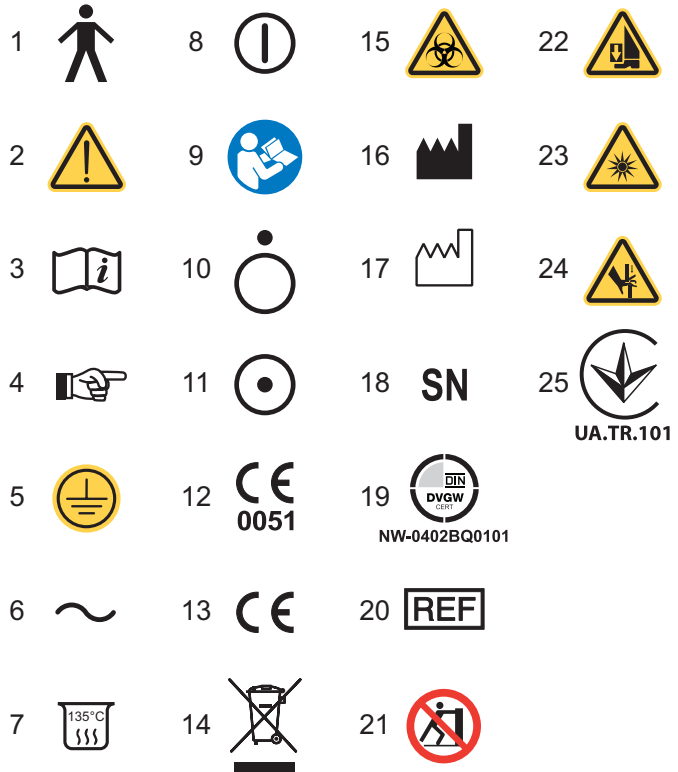

1.2. Intended use

- The Skema 6 and Skema 8 series of operatories are medical devices intended for dental treatment.
- The instrument board may hold up to 6 instruments.
- The assistant's board can hold 2 suction tubes and 3 instruments.
- This equipment must be used only by adequately trained personnel (doctors and paramedics).
- The device is intended for **non-continuous operation** (see the operating times of the individual parts in the dedicated sections).
- The device is classified as pollution degree 2.
- Overvoltage class: II.

1.2.1. Classification and reference standards

- **MEDICAL DEVICES classification**
Classification of the dental unit in accordance with the indications given in annex IX of directive 93/42 and subsequent changes/EEC: Class IIa.
- **ELECTRICAL MEDICAL EQUIPMENT classification**
Classification of the dental unit in accordance with standard EN 60601-1 for safety of medical equipment: **Class I - Type B**.
- **Reference standards**
The operating units of the SKEMA 6 and Skema 8 series are devices designed in compliance with CEI EN 60601-1, CEI EN 60601-1-2, ISO 7494, ISO 6875 and EN 1717 (type AA or AB if the MWB system is present) regarding water supply safety devices.
- **Classification of RADIO DEVICES AND COMMUNICATION TERMINALS** (only when the WIRELESS foot control is present)
Equipment classification according to Directive 99/05/EC Art.12: **Class I**.



1.2.2. Environmental conditions

The equipment is to be installed in rooms that satisfy the following requirements:

- temperature between 10 and 40°C.
- relative humidity between 30 and 75%.
- atmospheric pressure ranging from 700 to 1060 hPa.
- altitude ≤ 3000 m;
- air pressure entering equipment ranging from 6 to 8 bar.
- water hardness entering equipment not over 60 mg/l.
- water hardness at the equipment inlet must not be above 25 °f (French degrees) or 14 °d (German degrees) for untreated drinking water. For water with a higher hardness degree, it is recommended to soften water until it reaches a hardness degree between 15 and 25 °f (French degrees) or between 8.4 and 14 °d (German degrees);
- water pressure entering equipment ranging from 3 to 5 bar.
- water temperature entering equipment not higher than 25°C.

1.2.2.1. Transport and packaging conditions

- Temperature: from -10 to 70°C;
- Relative humidity: from 10% to 90%;
- Atmospheric pressure: from 500 to 1060hPa.

1.2.3. Warranty

CEFLA s.c. stands behind its products warranting safety, reliability and performance.

The warranty is valid only under the following terms:

- The conditions given on the warranty certificate are observed.
- Performing annual scheduled maintenance.
- The equipment is used only as instructed in this manual.
- The electrical wiring in the room in which the equipment is installed must conform to IEC 60364-7-710 (standards for electrical wiring in medical and dental offices).
- A 3x1.5 mm² line protected by a bi-polar cut-out that conforms to applicable standards (10 A, 250 V, distance between contacts at least 3 mm) must be used to feed the equipment.



WARNING!

The color of the three wires (POWER, NEUTRAL and EARTH) should satisfy the requirements of current standards.

- Installation, repairs and, in general, any other operations requiring the casing to be opened are to be performed exclusively by personnel authorized by CASTELLINI.

1.2.4. Disposing the equipment when no longer used

As set out in Directives 2011/65/EU and 2012/19/EU, on the restrictions of the use of certain hazardous substances in electrical and electronic equipment along with collection, treatment, recycling and disposal of waste electrical and electronic equipment the latter must be treated as municipal waste, therefore sorted and collected separately. When new equipment of equivalent type is purchased the waste equipment should be returned to the distributor on a one-to-one basis for disposal. As far as reuse, recycling and other forms of waste recovery mentioned above are concerned, the manufacturer is responsible for the actions specified by individual local laws. Efficient collection of sorted waste separately to recycle and treat waste electrical and electronic equipment aids in preventing negative environmental impacts while protecting human health. In addition it facilitates recycling of the materials used to construct the equipment. Illegal waste disposal carries heavy fines defined by local laws.



WARNING!

The crossed out wheeled bin placed on the equipment indicates that the waste equipment must be collected separately from other waste.

1.3. Safety rules



WARNING!

- **All equipment is permanently installed.**
Depending on the type of chair the unit comes with, refer to the installation DATA given in paragraph “Specifications”.
CEFLA s.c. shall not be held liable for any personal injury or equipment damage resulting from failure to heed the precaution given above.
- **Floor condition**
The floor (continuous) should meet the load-bearing capacity set forth by DIN 1055, sheet 3. The weight of the dental unit including a 190 kg patient is about 350 kg/sq.m.
- This device may not be modified in any way without the authorisation of the manufacturer.
If the device is modified, appropriate examinations and tests need to be conducted in order to ensure continued safe use.
CEFLA s.c. shall not be held liable for any personal injury or equipment damage resulting from failure to heed the precaution given above.
- **Dental chair**
The maximum chair capacity is 190 Kg. This weight must never be exceeded.
- **Tray holders**
The maximum weights that can be held must never be exceeded:
 - Instrument tray attached to the instrument board maximum allowable load 2 Kg, evenly distributed.
 - Instrument tray attached to the instrument board maximum allowable load 1 Kg, evenly distributed.
 - Auxiliary instrument tray, maximum allowable load on tray 3.5 Kg (no x-ray film viewer) or 2.5 Kg (with x-ray film viewer).



- **Connections to external instruments**

The equipment can be hooked up only to other instruments that bear the CE mark.

- **Electromagnetic interferences.**

Use of electrical equipment that does not comply to standard IEC 60601-1-2 in the office or nearby may cause electromagnetic or other types of interferences resulting in dental unit malfunctions.

In these cases, shut off power to the dental unit before using this equipment.

- **Replacing the chucks.**

Operate the turbine release and contra angle only once the chuck has come to a complete stop. On the contrary, the locking system will wear down and the chucks can slip off causing injury. Use only high quality chucks with gauged diameter attachment. To check the state of the locking system, make certain the chuck is firmly secured to the instrument every day before starting work. Locking system defects caused by misuse are easily identified and not covered by the warranty.

- **Patients with pace makers and/or hearing aids.**

When treating patients with pace makers and/or hearing aids, take into consideration the effects the instruments may have on pace makers and/or hearing aids. Carefully read technical-scientific information available on this subject.

- **Implants.**

If the dental unit is used for implant operations using separate equipment designed for this purpose, shut off power to the dental chair to avoid unwanted movements resulting from faults and/or accidental start up of the controls.

- Do not forget to turn off the office's water supply and master switch on the equipment before leaving the surgery.

- The equipment is not protected against liquid penetration (IPX O).

- This equipment is not suitable for use in the presence of a mix of inflammable anaesthetic gas with oxygen or nitrous oxide.

- This equipment must be stored properly so that it is kept in top working order at all times. The manufacturer shall not be held responsible for misuse, carelessness or improper use of the equipment.

- This equipment is to be used exclusively by qualified personnel (doctors and paramedics) with the proper training.

- The user must be present at all times when the equipment is turned on or ready for start-up. In particular, never leave the equipment unattended in the presence of children/the mentally disabled or other unauthorised personnel in general.

Any companions must keep out of the area in which treatment is performed and in any case under the responsibility of the operator. The area in which treatment is performed refers to the space around the dental unit plus 1.5 meters.

- **Quality of the water delivered by the dental unit.**

The user is responsible for the quality of the water delivered by the dental unit and must adopt measures to maintain it.

To ensure that you meet the water quality requirements, CEFLA s.c. advises you to equip the dental unit with an internal or external disinfection system. Once installed, the dental unit is exposed to contaminants originating from the water supply. For this reason, it is recommended to install and put it into operation only when you begin using it daily and to perform the decontamination procedures described in the relative chapters right from the first day of installation.

If the dental unit is equipped with a device for separation from the open water supply system (EN 1717), make sure that it also continuously adds disinfectant as required and check that the relative tank contains an adequate quantity (see the relative paragraph).

 **NOTE:** Contact your local dealer or Dental association for more detailed information about national laws and requirements.

- **Applied Parts.**

The parts of the device that during normal use necessarily come into contact with the patient for the device to be able to perform its functions are: Dental chair upholstery, armrest, polymerising lamp fibre optics, terminal part of the syringe, single-use camera protection, scaler bits, drill handpieces, cannula suction terminals.

Non applied parts that may come into contact with the patient are: dental chair armrest support, dental chair lower casing, patient-side hydro unit casing, cup water delivery spout, bowl, suction tubes, handpiece body.

-  **WARNING! Moving the dental chair.**

Make sure that the patient is ready to collaborate: ask him/her to keep his/her hands and feet close, avoiding incorrect postures.

Check that the patient is sitting properly when moving the dental chair (see figure).

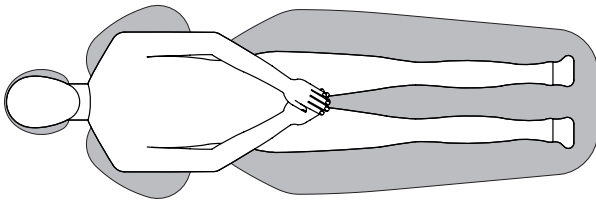



1.4. Cleaning and disinfecting

Cleaning is the first step of any disinfecting process. Physically scrubbing with detergents and surface-active substances and rinsing with water removes a considerable amount of micro organisms. If a surface is not clean first, the disinfecting process cannot be successful. If a surface cannot be adequately cleaned, it should be protected with barriers.

The outer parts of the equipment must be cleaned and disinfected using a product for hospital use with indications for HIV, HBV and tuberculocide (medium-level disinfectant) specifically for small surfaces.

The various drugs and chemical products used in dentist's surgeries may damage the painted surfaces and the plastic parts.

Research and tests run show that the surfaces cannot be fully protected against the harsh action of all products available on the market. We therefore recommend protecting with barriers whenever possible. The harsh actions of chemical products also depend on the amount of time they are left on the surfaces. It is therefore important not to leave the product on the surfaces longer than the time specified by the manufacturer.

It is recommended to use the specific medium-level disinfectant, STER 1 PLUS (CEFLA s.c.), which is compatible with:

- Coated surfaces and plastic parts.
- Upholstery.



WARNING!

Any splashes or spots of mordant will stain the MEMORY FOAM upholstery. Immediately rinse with plenty of water if acid spatters on the upholstery.

- Uncoated metal surfaces.

If you do not use STER 1 PLUS, it is recommended to use products that contain at maximum:

- Ethanole. Concentration: maximum 30 g per 100 g of disinfectant.
- 1-propanol (N-propanol, propyl alcohol, N-propyl alcohol). Concentration: maximum 20 g per 100 g of disinfectant.
- Combination of ethanole and propanole. Concentration: the combination of the two should be maximum 40 g per 100 g of disinfectant.



WARNING!

- Do not use products containing isopropyl alcohol (2-propanol, iso-propanol).
- Do not use products that contain sodium hypochlorite (bleach).
- Do not use cleaners that contain phenol.
- Do not spray the selected products directly on the surfaces.
- All products must be used as directed by the manufacturer.
- Do not mix the STER 1 PLUS disinfectant with other products.



WARNING!

The products suggested are compatible with the materials of the equipment, however damages may occur to surfaces and materials resulting from the use of different products, even if not included in the above list of excluded products.

Cleaning and disinfecting instructions.

Clean and disinfect with single-use non-abrasive paper (avoid using recycled paper) or sterile gauze.

Do not use sponges or in any case, any material that can be reused.



WARNING!

- Shut off the dental unit prior to clean and disinfecting the external parts.
- All material used to clean and disinfect must be thrown away.

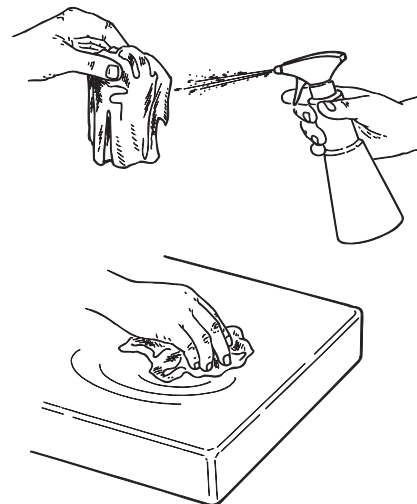
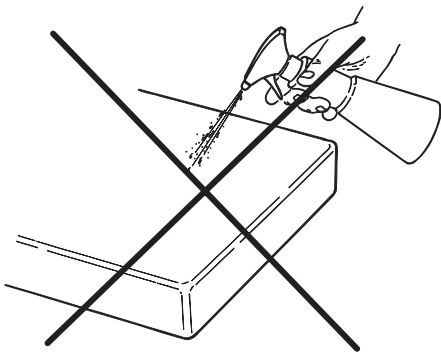



2. Description of the equipment

2.1. Nameplate

The nameplate is found on the arm between the dental chair and hydrogroup.

Data given on plate:

- Manufacturer's name
- Name of equipment
- Voltage
- Type of current
- Frequency
- Maximum power absorbed
- Serial number
- Month and year of construction

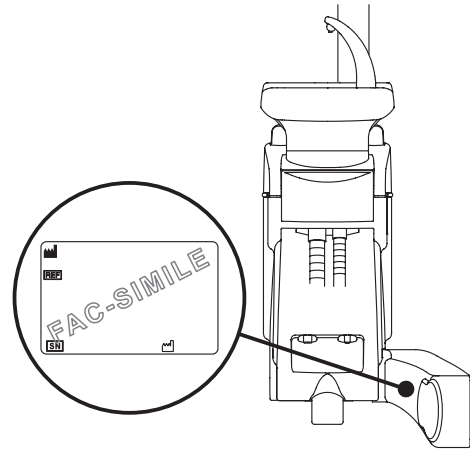

2.2. Dental units

The dental units of the SKEMA 6 series with FULL TOUCH console come in the following models:

SKEMA 6 model.

"RS" version instrument board (instruments will return to their original position through the pulling action of the spring-operated arms) attached to a double supporting arm, one of which is articulated while the other is autobalancing.

Description of equipment:

- [a] Hydrogroup
- [b] Adjustable arm
- [c] Instrument board
- [d] Doctor's console
- [e] Tray holder
- [f] Assistant's board
- [g] Assistant's control console
- [h] Utility service center
- [i] Multifunction foot control
- [l] Water to cup
- [m] Bowl
- [n] Autobalancing arm
- [q] Instrument tray on assistant's board (optional)
- [z] NEW SKEMA dental chair

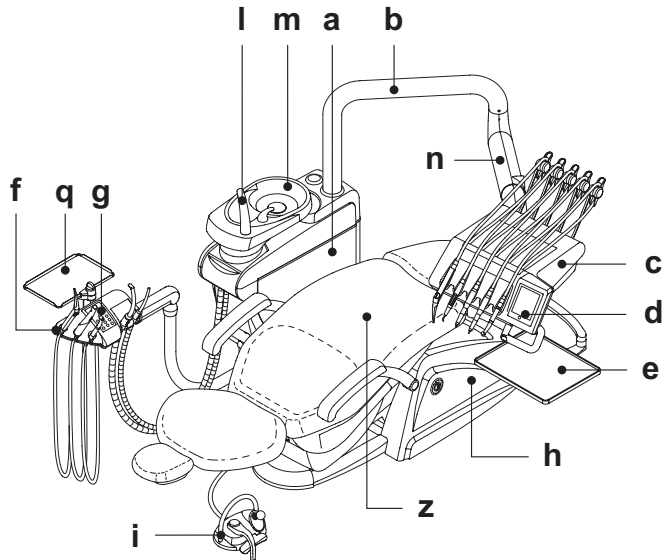

SKEMA 6 CP.

Instrument board version CP (the instruments are placed vertically in position) mounted on double arm of which one is articulated and self-balanced.

Description of equipment:

- [a] Hydrogroup
- [b] Adjustable arm
- [c] Instrument board
- [d] Doctor's console
- [e] Tray holder (optional)
- [f] Assistant's board
- [g] Assistant's control console
- [h] Utility service center
- [i] Multifunction foot control
- [l] Water to cup
- [m] Bowl
- [n] Autobalancing arm
- [q] Instrument tray on assistant's board (optional)
- [r] Viewer for panoramic x-rays (optional)
- [z] NEW SKEMA dental chair

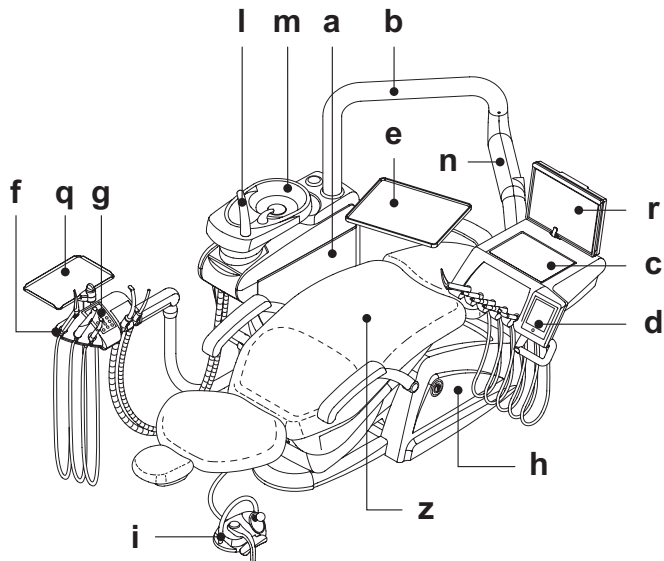



The dental units of the SKEMA 8 series come in the following models:

SKEMA 8 RS.

"RS" version instrument board (instruments will return to their original position through the pulling action of the spring-operated arms) attached to a double supporting arm, one of which is articulated while the other is autobalancing.

Description of equipment:

- [a] Hydrogroup
- [b] Adjustable arm
- [c] Instrument board
- [d] Doctor's console
- [e] Tray holder
- [f] Assistant's board
- [g] Assistant's control console
- [h] Utility service center
- [i] Multifunction foot control
- [l] Water to cup
- [m] Bowl
- [n] Autobalancing arm
- [q] Instrument tray on assistant's board (optional)
- [z] THESI 3 dental chair

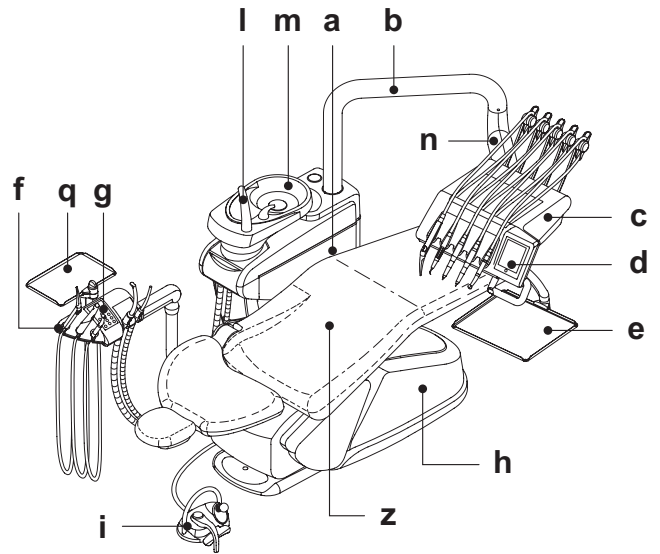

SKEMA 8 CP.

Instrument board version CP (the instruments are placed vertically in position) mounted on double arm of which one is articulated and self-balanced.

Description of equipment:

- [a] Hydrogroup
- [b] Adjustable arm
- [c] Instrument board
- [d] Doctor's console
- [e] Tray holder (optional)
- [f] Assistant's board
- [g] Assistant's control console
- [h] Utility service center
- [i] Multifunction foot control
- [l] Water to cup
- [m] Bowl
- [n] Autobalancing arm
- [q] Instrument tray on assistant's board (optional)
- [r] Viewer for panoramic x-rays (optional)
- [z] THESI 3 dental chair

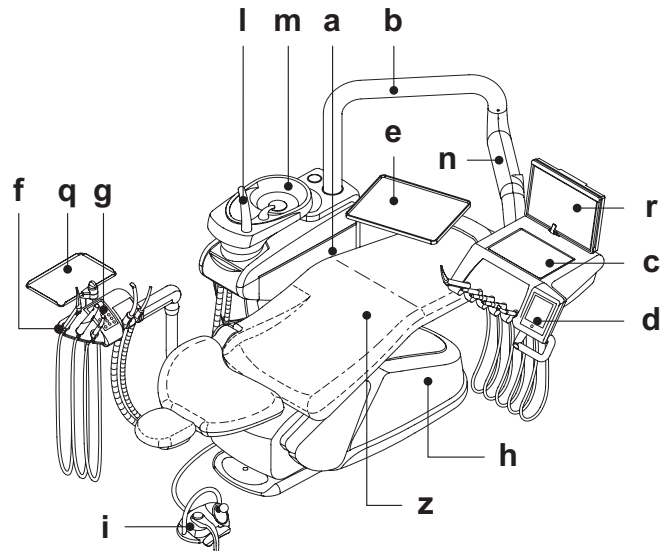



2.3. Dental chair

① NEW SKEMA dental chair

Description of the chair.

- [a] Headrest
- [b] Back
- [c] Left mobile armrest (optional)
- [d] Right mobile armrest (optional)
- [e] Safety foot board
- [r] Sliding footrest

Operating times.

The operating and rest times are as follows: **work 25 sec. - rest 10 min.**

Maximum weight capacity.

The maximum chair capacity is 190 Kg.

 **WARNING!**
Do not exceed this value.

Warnings for use.

 **WARNING: RISK OF CRUSHING.**
Despite the safety systems installed to prevent crushing, certain chair positions might create dangerous conditions. The operators need to check the correct posture of the patients during chair movement.

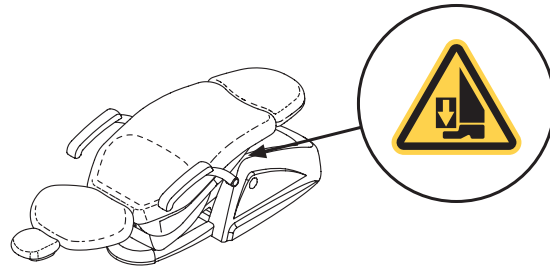
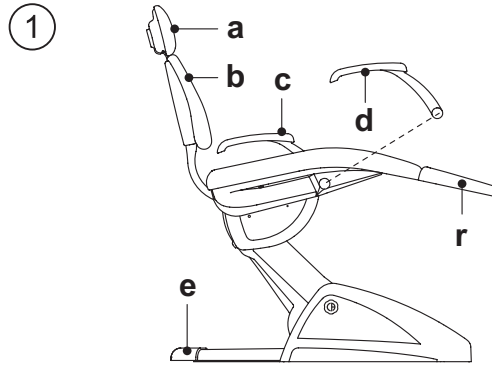

② THESI 3 dental chair

Description of the chair.

- [A] Headrest.
- [B] Back.
- [C] Fixed left-hand armrest (optional).
- [D] Right mobile armrest (optional).
- [E] Safety foot board.

Operating times.



The operating and rest times are as follows: **1 min. operation - 14 min. rest**

Maximum weight capacity.

The maximum chair capacity is 190 Kg.

 **WARNING!**
Do not exceed this value.

Warnings for use.

  **WARNING: RISK OF CRUSHING.**
Despite the safety systems installed to prevent crushing, certain chair positions might create dangerous conditions. The operators need to check the correct posture of the patients during chair movement.

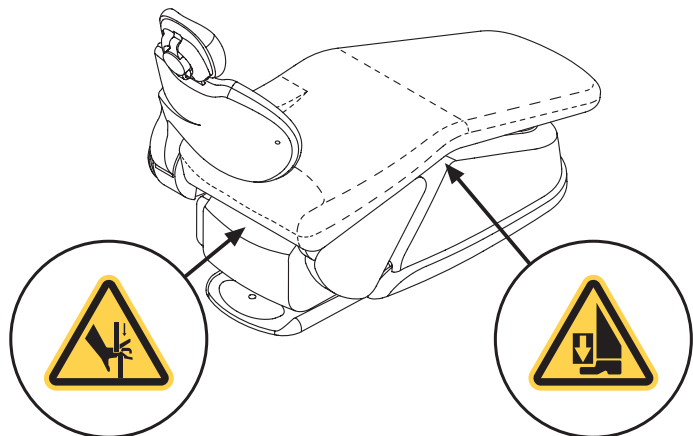
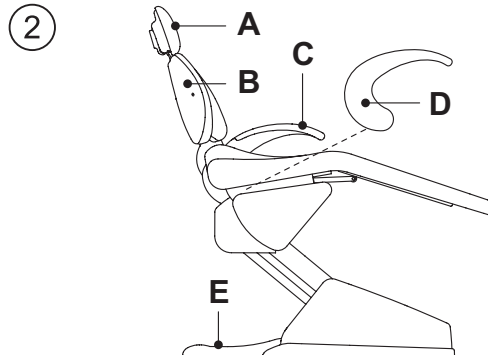



3. Turning on the dental operator

Press the main switch (f1) on the dental chair casing and check on the control console that:

- **“POWER” led (g) on**
 - equipment on
 - pneumatic system connected
 - water system connected
- **“POWER” led (g) off**
 - equipment off
 - pneumatic system disconnected
 - water system disconnected

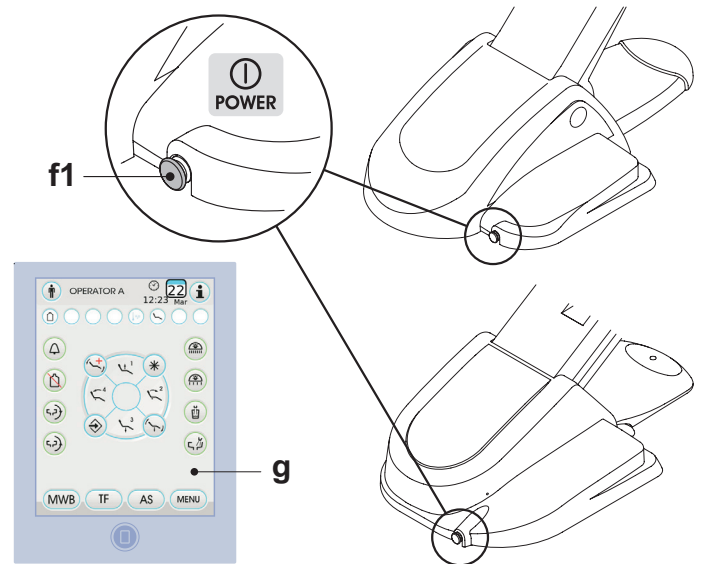

4. Dental chair operation

1 NEW SKEMA dental chair

The dental chair NEW SKEMA can be moved as follows:

- Chair seat up/down
- Back up/down with inclination of the chair seat (Trendelenburg compensated)

The dental chair can be operated from the following places:

- Instrument board [a] (see par. 5).
- Multifunction foot control [b] (see par. 5.2).
- Assistant's board [c] (see par. 6).

The footrest [r] can be pulled out by about 10 cm.

Dental chair movement shutdown

With the instruments in rest position, you can disable the dental chair movements (see paragraph 5.1.1.2.9.).

The movement disabling is shown on the control panel display by the relevant icon (A).

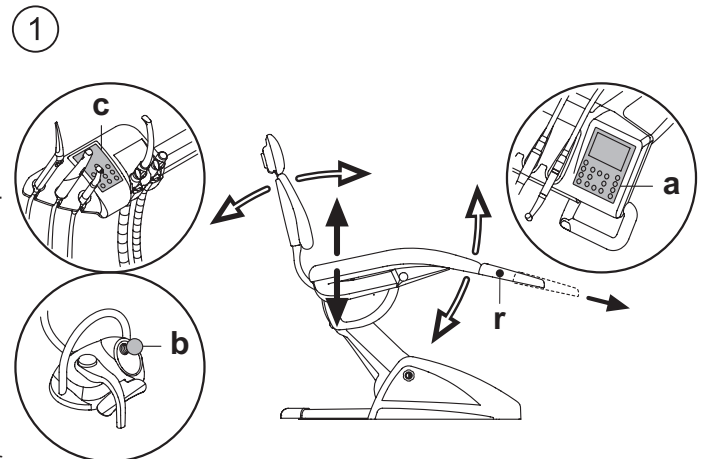



2 THESI 3 dental chair

The THESI 3 dental chair can make the following movements:

- Seat up and down
- Backrest up and down with automatic Trendelenburg position, sliding movement (forward displacement of the seat synchronous with backrest descent), knee articulation.

The dental chair can be operated from the following places:

- Instrument board [a] (see par. 5.)
- Multifunction foot control [b] (see par. 5.2.)
- Assistant's board [c] (see par. 6.)

Dental chair movement shutdown

With the instruments in rest position, you can disable the dental chair movements (see paragraph 5.1.1.2.9.).

The movement disabling is shown on the control panel display by the relevant icon (A).

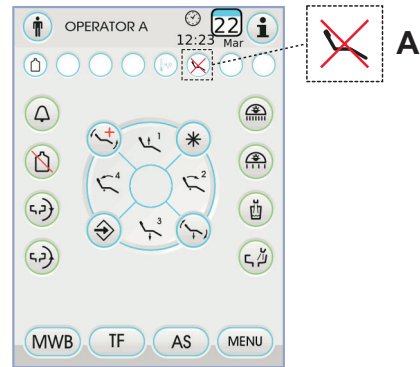
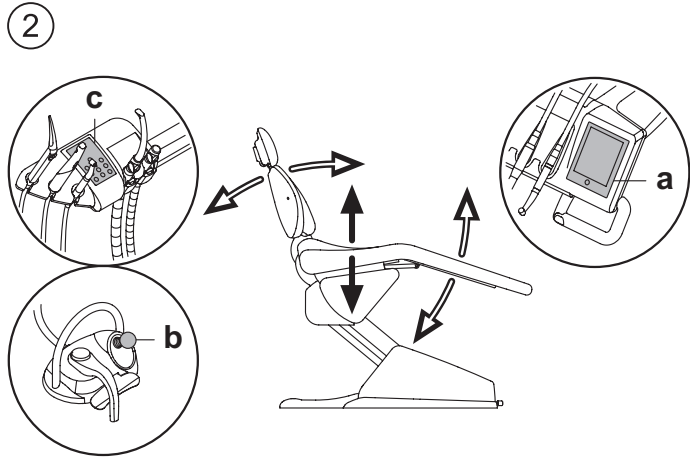

4.1. Safety devices

All the dental chairs have the following safety devices:

- The floor box is equipped with a device [i] that immediately stops the dental chair from moving down in the presence of an obstacle and automatically lifts it up to free the obstacle.
- The backrest is equipped with a device [m] that immediately stops the backrest from moving down in the presence of an obstacle and automatically lifts it up to free the obstacle.
- The arms of the assistant's board are equipped with a safety device [n] that immediately stops the dental chair from moving down if an obstacle is encountered and automatically moves it up to clear the obstacle.
- Dental chair movements:
 - with the instrument extracted NOT working: manual movements allowed, automatic movements inhibited, but if they are already in progress at the moment of extraction they are not interrupted;
 - with instrument extracted and working: all the dental chair movements are inhibited.

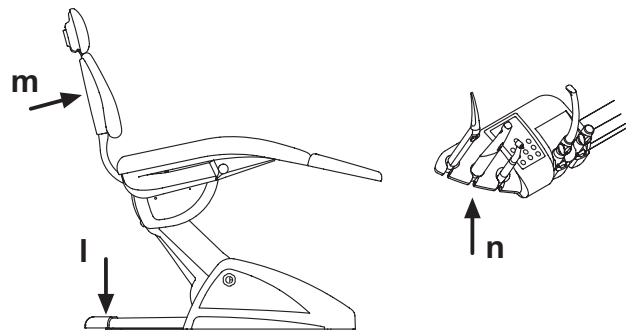

4.2. Emergency devices

! WARNING!

Use the devices below when movement of the equipment needs to be blocked:

- **Dental chair control buttons (a) or (c).**
Pressing any dental chair button blocks all movements.
- **Foot control (b).**
When the foot control is actuated, all movements of the equipment are blocked.
- **Foot board [i].**
Foot board activated: all movements are blocked.

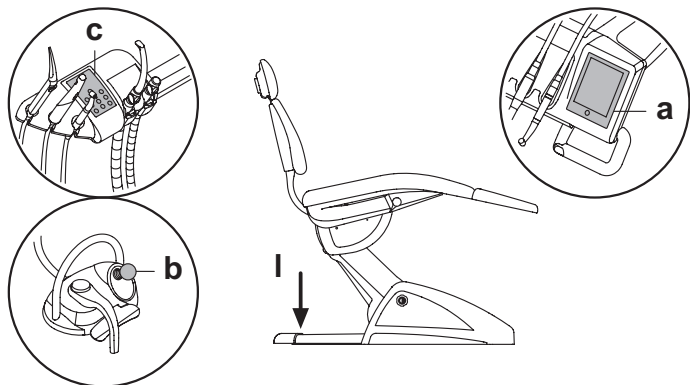

4.3. Adjustable headrest

The headrest may be of two types:

- ① with manual cushion lock lever
- ② with pneumatic cushion lock lever

Adjusting headrest height.

- with manual locking (1): The head rest blade is positioned through a magnetic clutch. The operator should pull up and/or push down the headrest until it is in the desired position.
- with pneumatic locking (2): Press and hold down the locking button (u) to position the headrest as desired. Once you have reached the desired position, release the button (u) to lock the headrest in place.

Adjusting the cushion:

- with manual lock (1): rotate the lock knob (k) anti-clockwise, position the cushion as desired and then retighten the lock knob.
- with pneumatic lock (2): press the lock button (u) and keep it pressed as you adjust the cushion as desired. Once the cushion is oriented as desired just release the button (u) to lock in place.

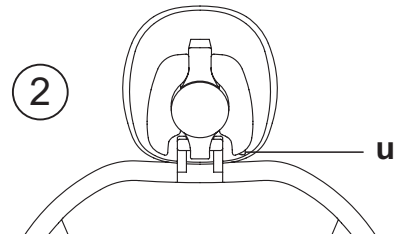
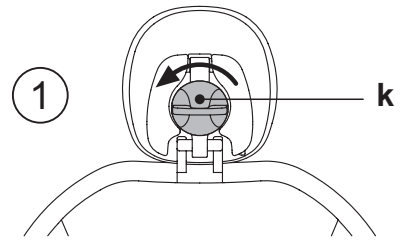

Proper positioning of the headrest.



WARNING!

For correct use of the headrest, position the patient's head as shown in the figure.

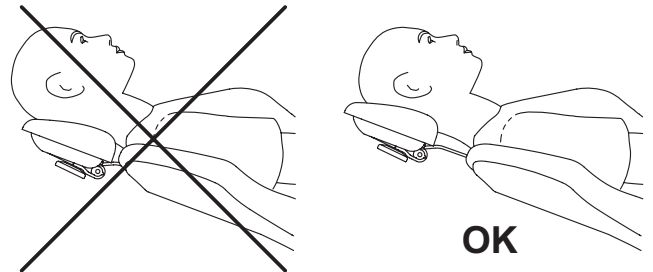

Important information.



WARNING!

- Maximum on-headrest load: 30 Kg.
- Do not attempt to move cushion while patient is resting against it.
- Do not attempt to modify the position of the cushion without first releasing the lock mechanism.
- In order to prevent the headrest from moving in an uncontrolled manner, hold it with both hands before disengaging the locking device.
- The pneumatic locking device is active only when the air circuit is pressurized and the dental unit is on.

4.4. Adjustable armrest (optional)

① NEW SKEMA dental chair

Pushing down the adjustable armrest.

Turn the adjustable armrest clockwise to move it down so that the patient can more easily get on and off the chair.

Taking off the adjustable armrest.

Put the armrest in a vertical position and pull it off.



WARNING!

Maximum weight supported by armrest: 68 kg.

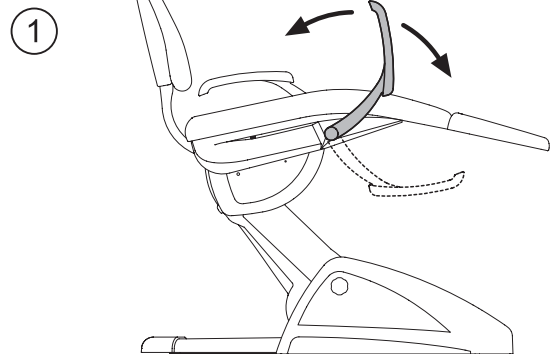

② THESI 3 dental chair

Pushing down the adjustable armrest.

Slightly pull the armrest towards you and turn it anticlockwise (towards to backrest) to make it easier for the patient to get on and off the chair.



NOTE: the armrest is not removable.



WARNING!

Maximum weight supported by armrest: 68 kg.

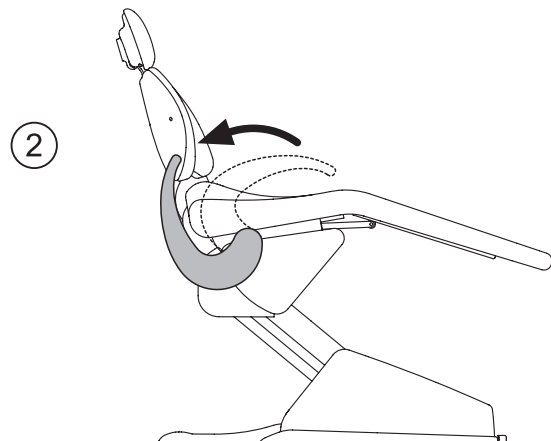

5. Instrument board operation

Layout of instruments.

The positions the instruments are placed in on the board are determined by the customer at the time of order.

Starting the instruments.

- The syringe is always on (see paragraph 5.3.).
- The curing light is turned on with the key when the instrument is withdrawn (see paragraph 5.7.).
- Intraoral camera turn on when the instrument is extracted (see paragraph 5.8.).
- The ZEN-Xi integrated sensor is started by turning its support to the "ACTIVE" position (see paragraph 5.9 and ZEN-Xi instructions for use).
- Once picked up, all the instruments are operated with the foot control. (see paragraph 5.2.).

Simultaneous use of the instruments.

A device sees that the instruments cannot be used simultaneously. The first instrument removed is operative while those removed there after are deactivated by this device.

This device allows the chuck to be replaced in one instrument while another is used on the patient.

Putting the instrument board place.

The instrument board can be moved in all directions. To adjust the height of the board and/or direct it horizontally, simply grasp the handle (**a**).

 **NOTE:** to release the pneumatic brake of the pantograph arm grip the handle placing your thumb on the tip (**B**).

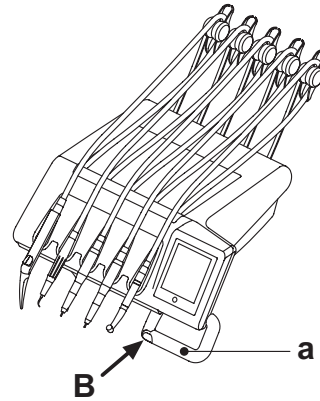

Instrument return stop arms (only in RS versions)

If this device is provided, the instrument return arm can be locked in the instrument extracted position.

When the device is used a click is heard about 2/3 of the total arm travel. To go back to the original condition, simply move the arm to the end of its travel [**A**].

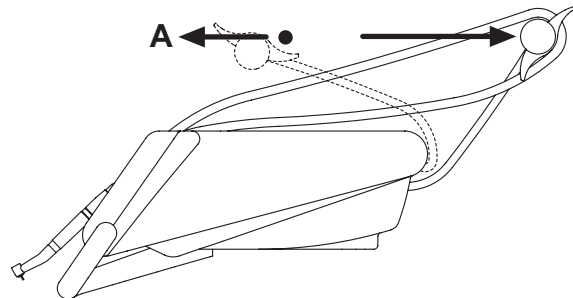

Tray holder module for SPRIDO version dentist's instrument board.

The tray holder module [**f**] is made of stainless steel and can easily be removed from its support.

WARNING!

Maximum weight allowed on instrument tray: 2 Kg evenly distributed.

Tray holder module for CP version dentist's instrument board.

The instrument holder [**q**] can be removed and sterilized in an autoclave up to 135°C.

WARNING!

Maximum weight allowed on instrument tray: 2 Kg evenly distributed.

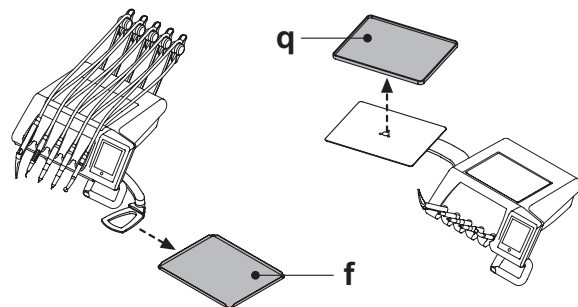

Cleaning the instrument board handle.

Press the release button [**e**] and then pull the handle [**d**] outwards and remove it.

Clean the dentist's module handle using a suitable product (see Paragraph 1.4.).

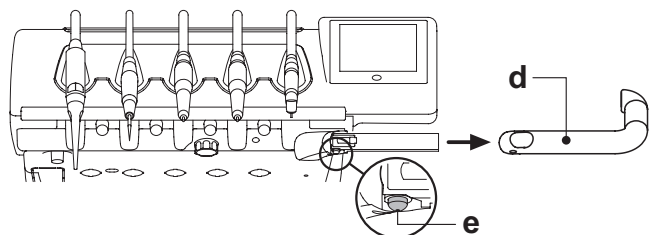



Cleaning the dentist's instrument board.

Clean the dentist's instrument board using a suitable product (see paragraph 1.4).

NOTES version boards: The instrument holder [u] and the hose cover [z] can also be sterilized in an autoclave up to 135°C.

NOTE CP version boards: The board protection [v] can be sterilized in an autoclave up to 135°C.

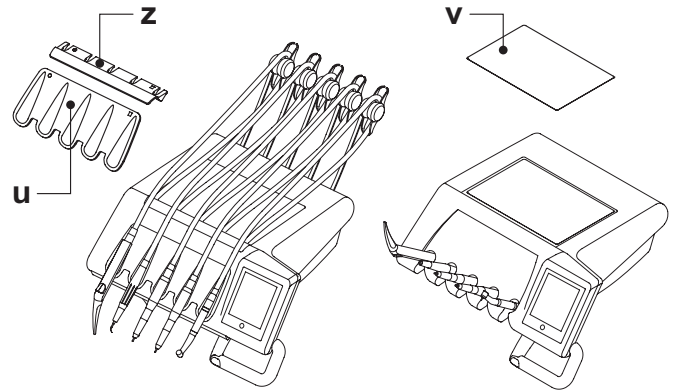

Removable instrument cords

All the instruments have removable cords to ease cleaning.

Follow the directions given below to remove the instrument cords:

RS version boards

- Open the front of the board, after releasing it with the button [k] found behind the console as shown in the figure.
- Loosen the plastic ring nuts and remove the cords.

CP version boards

Loosen the plastic ring nuts found underneath the board and then remove the cords.

WARNING!

- Shut off the operatory unit before attempting to take off the cords.
- After shutting off the operatory unit, empty the syringe's ducts by pressing and holding down the relative air and water buttons directly on the bowl until water spray is no longer present.
- The cords of the TURBINE, MICROMOTOR and SCALER contain water, therefore hold the end of the cord on the handpiece side over the bowl when removing the cord.
- When putting a cord back on, make certain the contacts are perfectly dry and the plastic ring nut is tight.
- Each cord may be remounted only in the position for the corresponding instrument.

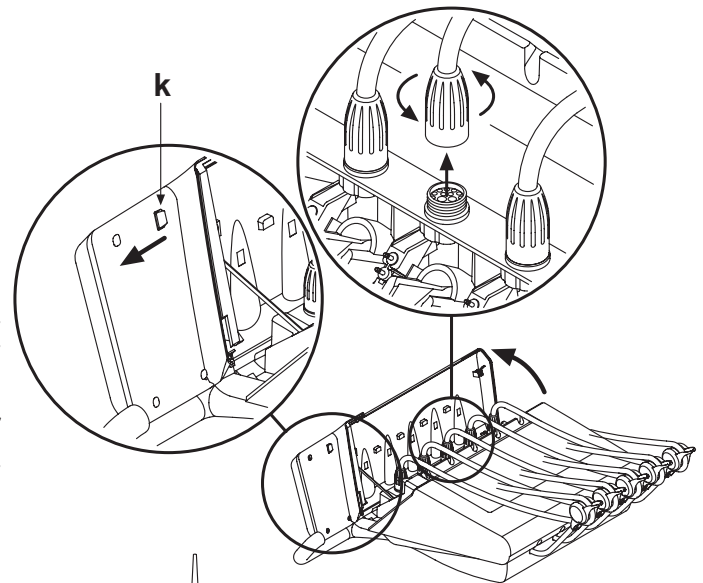

Clean the instrument cord using a suitable product (see Paragraph 1.4).

WARNING!

The instrument cords are NOT suitable for autoclave or cold disinfection.

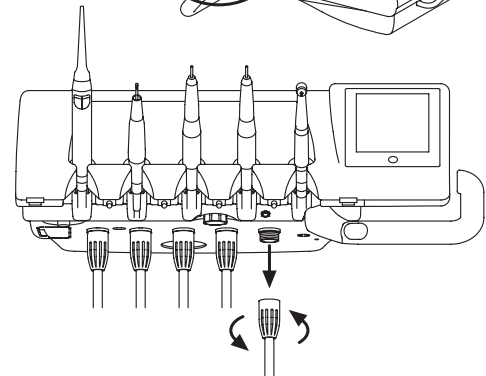

USB connector.

The dentist's instrument board is equipped with a USB port type "host" with a type A connector. The port can supply power to the connected device up to a maximum of 500 mA.

For use, see paragraphs 5.1.1.2.15. and 5.1.1.2.16.

WARNING!

- The connector is not protected against liquid penetration..
- Do not insert any metal objects in the connector other than a type A USB connector.
- It is advisable to always cover the connector with the rubber cap when not used.

Devices supported:

- USB 2.0 or 3.0 keys (USB flash drives) with a capacity between 128 MB and 64 GB,
- USB 2.0 or 3.0 external hard disks provided that they are powered separately,
- FAT and FAT32 formatted keys or hard disks, as readily available on the market.
- Devices formatted according to the NTFS standard are not supported.

NOTE: The port is equipped with a current limiting device that prevents damaging the console in the event that malfunctioning devices are accidentally connected.

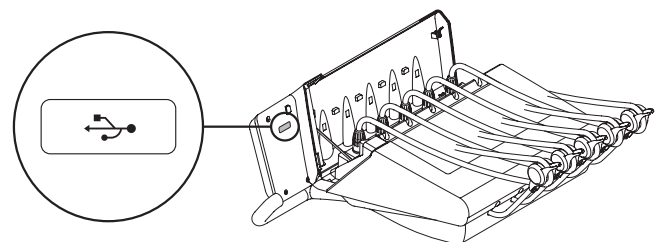





5.1. Doctor's control console

The Skema 6 and Skema 8 series dental units have a dentist's console with touchscreen interface composed of a glass multi-touch capacitive touch panel with rear projection and a 5.7" Wide TFT colour display with LED backlighting, resolution 640x480 pixels and 16.7 million colours.

Description of the capacitive buttons:

 Touchscreen disable button.

Description of the icon buttons visible on the touch panel:

 **MENU** Icon button to call up the GENERAL SETTINGS menu.

 Icon button to change operator.

 Icon button to call up the warning icons.

 Operating lamp on/off icon button.

 Icon button to reduce the operating lamp brightness.

 Cup water delivery control icon button.

 Assistant call icon button.

 S.S.S. system activation/deactivation icon button.

 Anticlockwise bowl movement control icon button. (active only with motor-driven bowl).

 Clockwise bowl movement control icon button. (active only with motor-driven bowl).

 Bowl water delivery control icon button.

 Dental chair function storage icon button.

 Emergency position recall icon button.

 Reset position recall icon button.

 Rinsing position recall icon button.

 **NOTE:** Operation of the dental chair movement icon buttons:

- Button pressed shortly: set position automatically reached
- Button held down: positioned reached by hand.

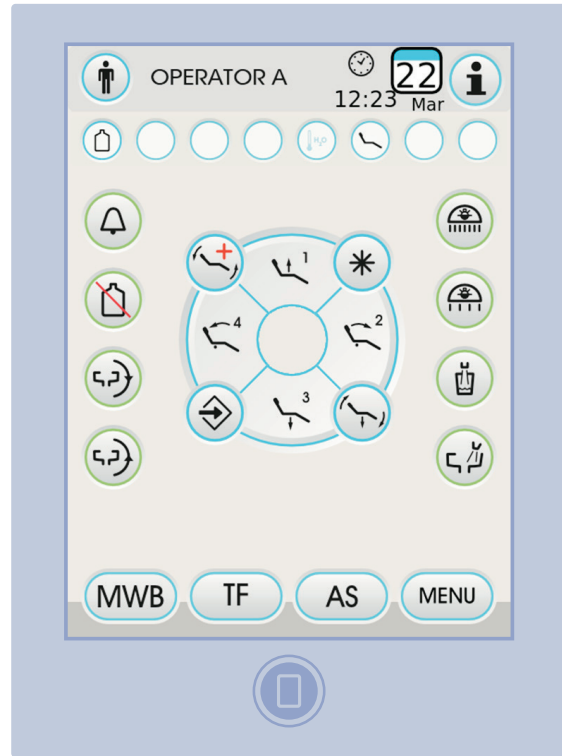

 Seat up and programmed position 1 recall icon button.

 Backrest up and programmed position 2 recall icon button.

 Seat down and programmed position 3 recall icon button.

 Backrest down and programmed position 4 recall icon button.



Warning icons.

Touching the icon button on the touch display, you can at any time view the warning icons that show the operating status of the dental unit. The warning icons viewable are the following:

- MWB** M.W.B. system running.
- Feeding with distilled water activated.
- Feeding with mains water activated.
- Peristaltic pump inserted with the delivered quantity of saline solution equal to 1.
- Distilled water level low.
- Low disinfectant liquid in the tank tubing.
- AUTOSTERIL cycle in progress.
- Suction tubes being washed.
- CP** Suction stopped due to full canister.
- Green: wireless foot control battery charged.
- Orange: wireless foot control battery 50% charged.
- Red: wireless foot control battery flat.
- Green: wireless foot control connected and active.
- Orange: wireless foot control connected but not active.
- Red: searching for connection to the wireless foot control.
- Pantograph arm brake engaged.
- Blue: COLD water-to-glass.
- Orange: WARM water-to-glass.
- Red: HOT water-to-glass.
- Dental chair position automated programme 1.
- Dental chair position automated programme 2.
- Dental chair position automated programme 3.
- Dental chair position automated programme 4.
- Dental chair movements blocked.

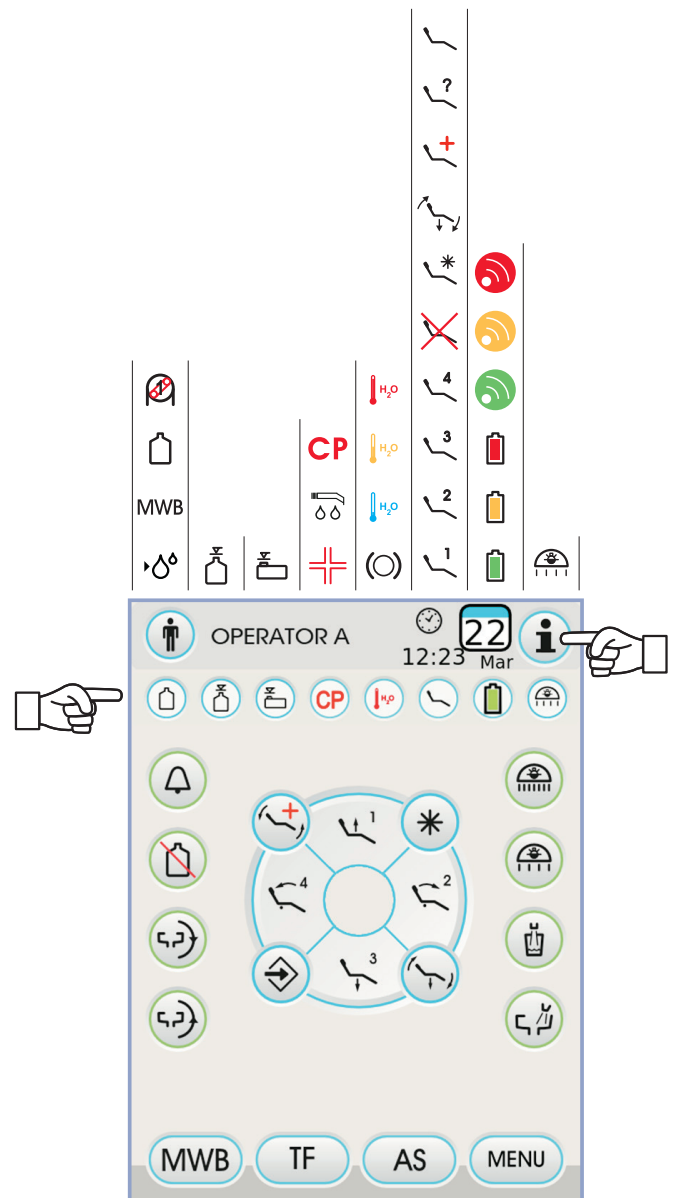

- Rinse automated programme chair position.
- Home automated programme chair position.
- Emergency automated programme chair position.
- Dental chair save function on.
- Chair position manually set up.
- Reduced operating lamp brightness.



5.1.1. User interface

When turned on, the dental unit performs a brief autodiagnosis cycle that ends when the main screen containing the name of the operator last set is displayed. As of this moment a number of settings can be edited from user-friendly menus (see next paragraphs).

Menu scrolling control.

- To access the setting menu, touch the icon button **MENU**.
- To access the various submenus, touch the relative icon button.
- To change a setting in a menu, touch the relative icon button.
- To change a numerical value in a menu, touch the icon buttons **-** or **+**.
- To exit from a menu, touch the icon button **ESC**.

Layout of the user interface menu.

The user interface menu is structured as shown in the diagram and includes the following menus:

- Operator selection (see paragraph 5.1.1.1.).
- Main settings (see paragraph 5.1.1.2.).
- BIOSTER disinfection cycle setting (see paragraph 5.1.1.2.1.).
- FLUSHING cycle setting (see paragraph 5.1.1.2.2.).
- W.H.E. system tank emptying (see paragraph 5.1.1.2.3.).
- Water-to-basin delivery setting (see paragraph 5.1.1.2.4.).
- Water-to-cup delivery setting (see paragraph 5.1.1.2.5.).
- Basin movement management (see paragraph 5.1.1.2.6.).
- Foot control setting (see paragraph 5.1.1.2.7.).
- Operating lamp setting (see paragraph 5.1.1.2.8.).
- Other settings (see paragraph 5.1.1.2.9.).
- Time and date setting (see paragraph 5.1.1.2.10.).
- Timer (see paragraph 5.1.1.2.11.).
- Favourite button customisation (see paragraph 5.1.1.2.12.).
- Operator database entry (see paragraph 5.1.1.2.13.).
- Language selection (see paragraph 5.1.1.2.14.).
- LAEC setting (see paragraph 5.1.1.2.15.).
- USB setup (see paragraph 5.1.1.2.16.).
- Image management (see paragraph 5.1.1.2.17.).

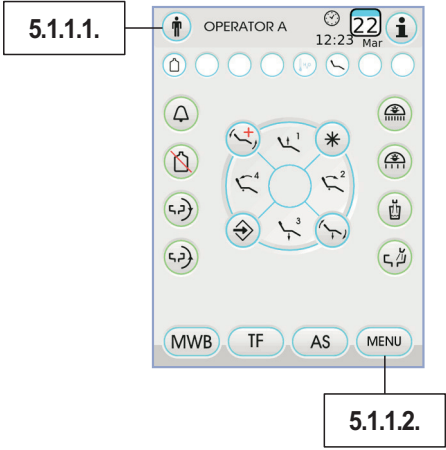

Error messages.

During the initial self-diagnostic cycle, the dental unit may detect some malfunctions in the internal system.

In this case, an error message is shown on the display (see paragraph 10) which remains visible until the operator touches the TOUCH DISPLAY.

If the malfunction is not hazardous, the dental unit will continue to operate.

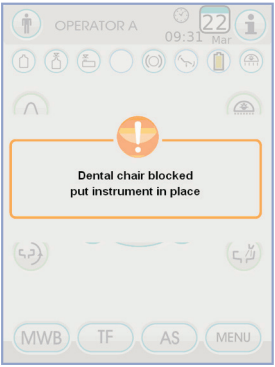

Stand-by mode.

The dental unit goes into power saving mode (stand-by) after approximately 10 minutes of non-use; this mode is shown by the CASTELLINI logo on the control panel display.

Normal operating conditions are restored as soon as any operation is performed.





5.1.1.1. Operator selection

The console allows managing 4 different operators. The following data can be set for each operator:

- Operator's name.
- Turbine and scaler power adjustment.
- 3 electric micromotor operating modes
- 4 scaler operating modes .
- Turning on and adjustment of the fibre optics of each instrument.
- Incremental or ON/OFF control of the turbine and the scaler power .
- Automatic dental chair movement programs.
- Hydro unit configuration parameters
- Favourite buttons.
- Time set in stopwatch.





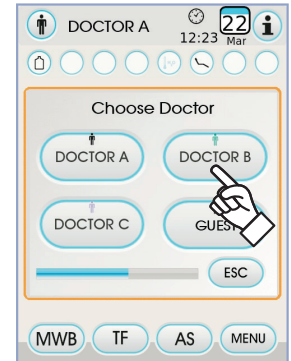
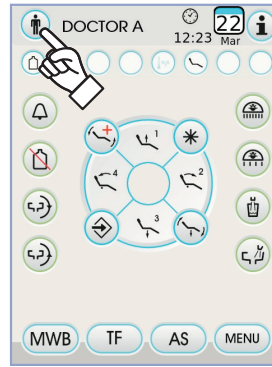





Operator selection

From the main page, touch the icon button  and then select the desired operator among the four ones available.





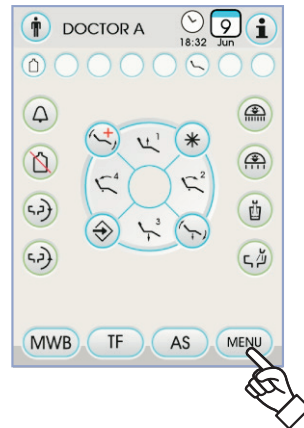

5.1.1.2. General settings

From the main page touch the icon button **MENU** to access the GENERAL SETTINGS menu containing the following icon buttons:

- AS** AUTOSTERIL disinfection cycle setting (only if the AUTOSTERIL system is present)
- TF** Flushing CYCLE SETTING (only if the FLUSHING system is present)
- MWB** M.W.B. system tank emptying (only if the M.W.B. system is present)
-  Water to bowl settings
-  Water to cup settings
-  Automatic bowl movement setting (only with motor-driven bowl)
-  FOOT CONTROL ADJUSTMENT
-  OPERATING LAMP ADJUSTMENT
-  OTHER SETTINGS
-  TIME AND DATE SETTING
-  CHRONOMETER
-  PERSONALIZATION OF FAVOURITE KEYS
-  OPERATOR DATA ENTRY
-  LANGUAGE SELECTION



-  LAEC setting
-  USB SETUP
-  Image management
-  ACCESS SERVICE MENU (for Technical Service, only)





5.1.1.2.1. AUTOSTERIL disinfection cycle setting

This setting is shared by all users.

Perform the following steps from the GENERAL SETTINGS menu:

- Touch the icon button **AS** to access the AUTOSTERIL DISINFECTION CYCLE SETTING submenu.

 **NOTE:** this submenu can be entered also by pushing at least for 2 seconds the AS key on the assistant's module.

 **NOTE:** This submenu cannot be entered if the disinfectant liquid tank is low (see paragraph 7.4.), an instrument is removed or the M.W.B. system is in an error state. An acoustic signal (BEEP) will signal the impossibility to enter the submenu.

- Set the disinfectant dwell time by touching the icon buttons **-** or **+**.

 **NOTE:** time setting ranges from a min. of 5 minutes to a max. of 10 minutes with intervals of 30 seconds.

 **WARNING!**

Recommended permanence time with PEROXY Ag+: 10 minutes. Recommended time 3% hydrogen peroxide (10 volumes) should be left in: 10 minutes.

- Withdraw the instruments to be treated (the corresponding icon will appear on the display):
 S1: syringe on instrument board.
 A: instrument in position A
 B: instrument in position B
 C: instrument in position C
 D: instrument in position D
 S2: syringe on assistant's board.
 F: instrument on assistant's board.
 CA: suction tubes.
 BC: water to cup duct.

 **NOTE:** pressing the  you can select/deselect disinfection of the cup water duct.

 **NOTE:** if the flushing system of suction cannulas is present, it is possible to select their flushing by simply putting them into the specially provided connect couplers (see paragraph 7.5.).

- To start the disinfection cycle, touch the icon button **PLAY** (see Paragraph 7.4).

 **NOTE:** the disinfection cycle can be started also by briefly pushing the AS key on the assistant's module.

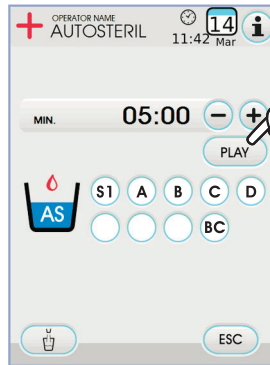
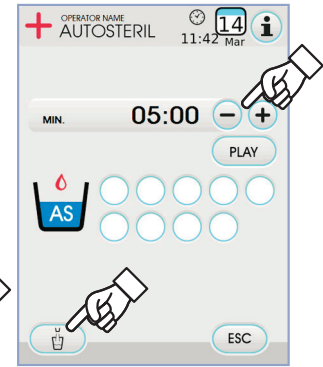
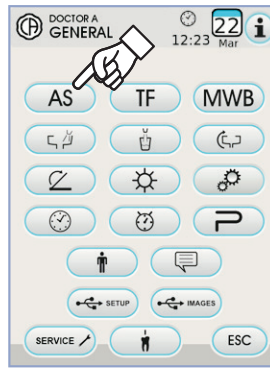



5.1.1.2.2. TIME FLUSHING CYCLE SETTING

This setting is shared by all users.

Perform the following steps from the GENERAL SETTINGS menu:

- Touch the icon button **TF** to access the TIME FLUSHING CYCLE SETTING submenu.

NOTE: this submenu cannot be entered if the distilled water tank is low (see paragraph 7.2.). A message on the control panel display and an acoustic signal (BEEP) will signal the impossibility to enter the submenu.

- Set the flushing time by touching the icon button **-** or **+**.

NOTE: the time may range from at least 1 minute to at most 5 minutes, with 1 minute intervals.

NOTE: for the distilled water tank, it is advisable not to set a time longer than 2 minutes.

- Withdraw the instruments to be treated (the corresponding icon will appear on the display):

S1: syringe on instrument board.

A: instrument in position A

B: instrument in position B

C: instrument in position C

D: instrument in position D

S2: syringe on assistant's board.

F: instrument on assistant's board.

NOTE: the TIME FLUSHING CYCLE does not start if at least one instrument is not selected.

- To start the TIME FLUSHING cycle, touch the icon button **PLAY** (see paragraph 7.6.).

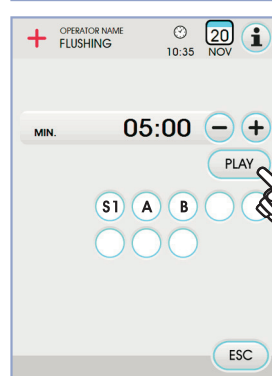
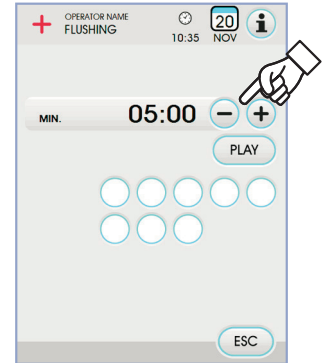
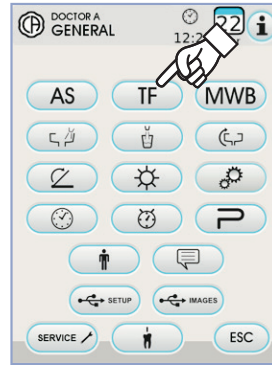

5.1.1.2.3. M.W.B. system tank emptying

This function is used to empty the M.W.B. system's water circuit (see paragraph 7.3.) if the dental unit is not going to be used for several days or if you want to drain the water present in the system.

Perform the following steps from the GENERAL SETTINGS menu:

- Touch the icon button **MWB** to access the M.W.B. SYSTEM TANK EMPTYING submenu.
- Place the cup (**e**) provided under the water fountain.
- Touch the icon button **PLAY** to start the emptying cycle.

NOTE: the emptying cycle does not start if the S.S.S. system is active or the M.W.B. system is in an error state.



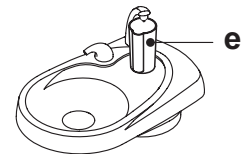
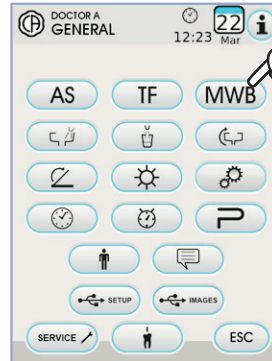

- Once the drainage cycle is complete, you can turn off the dental unit to reset the system should you wish to resume work.







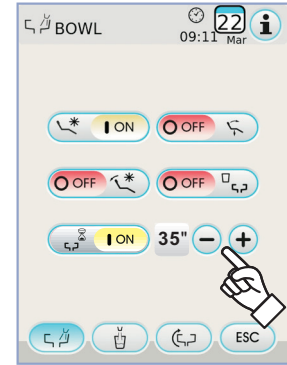
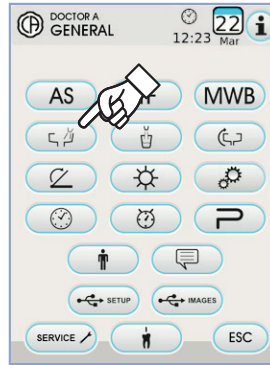

5.1.1.2.4. Bowl water delivery setting

From the GENERAL SETTINGS menu touch the icon button  to access the BOWL WATER SETTING submenu containing the following icon buttons:

-  Bowl flushing controller with dental chair brought to rinse position.
-  Bowl flushing controller with dental chair brought to reset position.
-  Cuspidor bowl flushing automatism with return from the rinse position for the chair
-  A Bowl flushing controller with cup call
-  Setting of timed or ON/OFF bowl flushing
- 35** Bowl flushing time (in seconds)



- To select/deselect a function, touch the relative icon button.
- To change the bowl flushing time, touch the icon buttons  or .
- To confirm the selected settings, it is sufficient to exit this submenu by touching the icon button .



5.1.1.2.5. Cup water delivery setting

From the GENERAL SETTINGS menu touch the icon button to access the CUP WATER SETTING submenu containing the following icon buttons:



COLD cup water selection



WARM cup water selection



HOT cup water selection

1.5

Cup water delivery time (in seconds)



Cup water delivery automatic function with rinse position recall



Distilled water tank depressurization automatic function with chair home position recall

- To select/deselect a function, touch the relative icon button.
- To change the cup water delivery time, touch the icon buttons or .

NOTE: the cup time of filling can be set up from a minimum of

1 second to a maximum of 10 seconds with increments of 0.1 seconds.

- To confirm the selected settings, exit this submenu by touching the icon button .

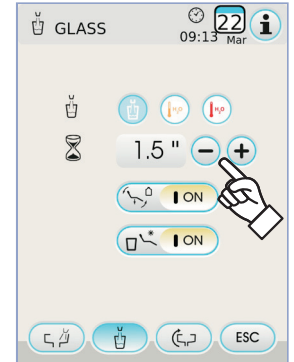
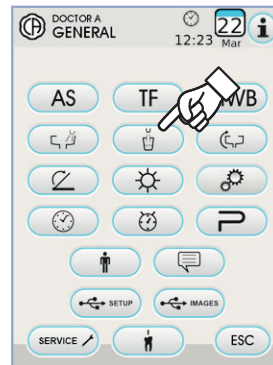

5.1.1.2.6. Automatic bowl movement setting

From the GENERAL SETTINGS menu touch the icon button to access the AUTOMATIC BOWL MOVEMENT SETTING submenu containing the following icon buttons:



Bowl rotation automatic function with chair rinse position recall



Bowl rotation automatic function with chair home position recall



Bowl rotation automatic function with automatic dental chair program recall



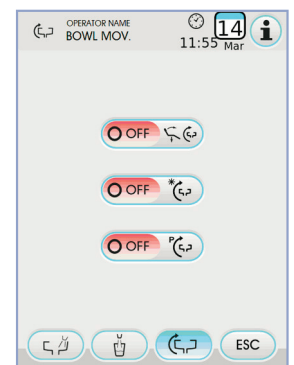

- To select/deselect a function, touch the relative icon button.
- To confirm the selected settings, it is sufficient to exit this submenu by touching the icon button .







5.1.1.2.7. Foot control adjustment



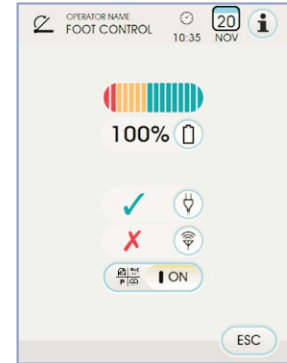
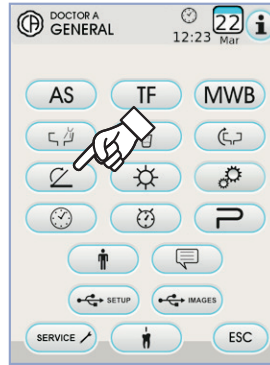

From the GENERAL SETTINGS menu touch the icon button  to access the FOOT CONTROL ADJUSTMENT submenu containing the following icons:

-  Cable connection icon
(only with wireless foot control)
-  Wireless connection status icon
(only with wireless foot control)
-  Battery percentage charge icon
(only with wireless foot control)
-  Foot control joystick with extracted instrument operation setting



 **NOTE:** the first 3 icons are just for signalling, while the fourth one allows to select/deselect the operation mode of the foot control upper joystick.
This setting is shared by all users.

To select/deselect the type of foot control operation, touch the relative icon button  :

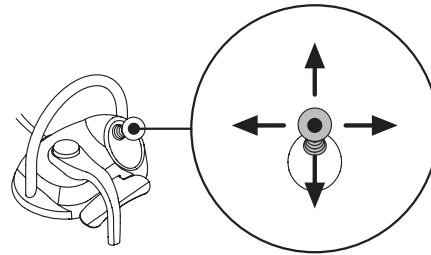

- OFF The joystick activates the chair manual movements (default).
- ON The joystick is used for the following functions:
 -  ON/OFF control for micromotor rotation direction inversion, scaler ENDO function activation , camera MIRROR function activation.
 -  ON/OFF control for peristaltic pump activation.
 -  ON/OFF control for operating lamp.
 -  Instrument memory change.





To confirm the selected settings, exit this submenu by touching the icon button  .

5.1.1.2.8. Operating lamp adjustment

From the GENERAL SETTINGS menu touch the icon button  to access the OPERATING LAMP SETTING submenu containing the following icon buttons:

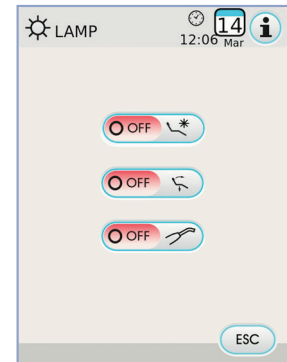
-  Light off automatism with chair rinse position recall
-  Light off automatism with chair home position recall
-  Lamp brightness reduction automatism with curing lamp instrument removal (only with VENUS PLUS –L LED lamp)



 **NOTE:** with the off-control automatism activated, it is sufficient to recall any chair movement to turn on again the operating light.

 **NOTE:** with the brightness reduction automatism activated, it is sufficient to replace the curing lamp instrument to reactivate the set brightness.

To select/deselect an automatic function, touch the relative icon button.
To confirm the selected settings, it is sufficient to exit this submenu by touching the icon button  .



5.1.1.2.9. Other Settings

These settings are alike for all operators.

From MAIN SETTINGS menu, touch icon button to access the OTHER SETTINGS sub-menu including the following icon buttons:



Pantograph arm brake release activation/deactivation (RS models only)



Touch display acoustic signal activation/deactivation



Dental chair movement activation/deactivation



Brake sensitivity adjustment (RS models only)



Display brightness adjustment

- To activate/deactivate pantograph arm brake release, touch the relative icon button.

NOTE: when the brake cannot be released, it is indicated by a dedicated icon on the TOUCH DISPLAY (see paragraph 5.1.).



WARNING!

For greater working safety, this operation is obligatory if you need to use an external electric scalpel.

- To activate or deactivate an acoustic signal each time the TOUCH DISPLAY is touched.
- To enable/disable the dental chair movements, touch the relative icon button.

NOTE: when the chair is locked, it is indicated by a dedicated icon on the TOUCH DISPLAY (see paragraph 5.1.).



WARNING!

For greater working safety, this operation is obligatory if you need to use an external electric scalpel.

- To adjust the brake activation sensitivity, touch the relative icon buttons or .

NOTE: the settable value ranges from 1 to 5.

- To adjust the display brightness, touch the relative icon buttons or .

NOTE: the settable value ranges from 1 to 10.

- To confirm the selected settings, exit this submenu by touching the icon button .

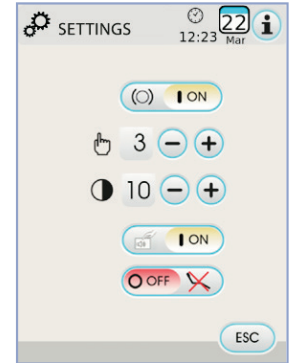
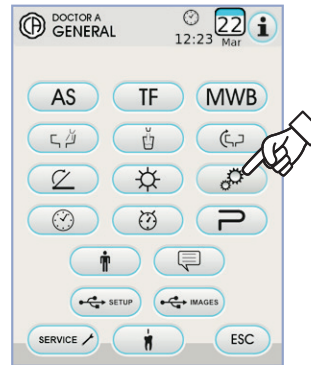

5.1.1.2.10. Time and date setting

This setting is shared by all users.

From the GENERAL SETTINGS menu touch the icon button to access the TIME AND DATE SETTING submenu .

- To change the data displayed, touch the relative icon buttons or .
- To select the type of time display, tap the relative icon button:

12-hour display.

24-hour display.

- To confirm the selected settings, exit this submenu by touching the icon button .

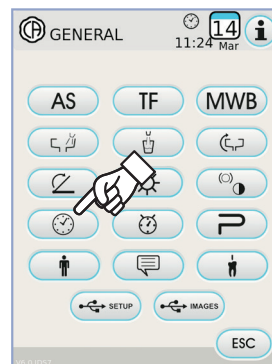



5.1.1.2.11. Chronometer

From the GENERAL SETTINGS menu touch the icon button to access the CHRONOMETER SUBMENU.

- To change the various data displayed, touch the relative icon buttons or .

NOTE: the time can be set from 00:00:00 to 10:59:59.

- Once you have set the time, touch the icon button to start the countdown.

NOTE: at this point, you can exit this menu by touching the icon button without interrupting the countdown.

- To suspend the countdown touch icon button .
- To interrupt the countdown and take stopwatch back to the last set time, touch icon button .
- When the set time runs out, the dental unit emits an intermittent signal and the CHRONOMETER menu is once again shown on the TOUCH DISPLAY. To interrupt the intermittent signal, touch the icon button or any button on the console.

NOTE: the last time set remains stored.

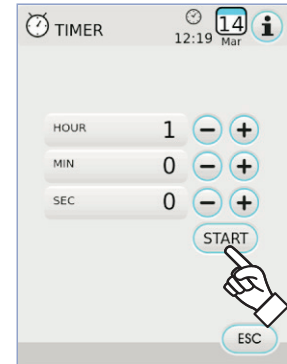

5.1.1.2.12. Personalization of favourite keys

This submenu allows you to select the function to attribute to the 3 lower icons visible in the main page.

From the GENERAL SETTINGS menu touch the icon button to access the FAVOURITE BUTTONS CUSTOMISATION submenu where you can view the 3 positions modifiable with the icons of the functions currently set.

- To change the function for a specific position, touch the relative icon buttons or .
- The settable functions are the following:

- Vacuum.
- Other settings.
- Stopwatch.
- AUTOSTERIL** disinfection cycle setting. (if **AUTOSTERIL** system is installed, only).
- FLUSHING** cycle setting (if **TIME FLUSHING** system is installed, only).
- Foot control setting.
- M.W.B.** tank emptying system (if **M.W.B.** system is installed, only).
- LAEC** settings (if **LAEC** is installed, only).

- To confirm the selected settings, exit this submenu by touching the icon button .

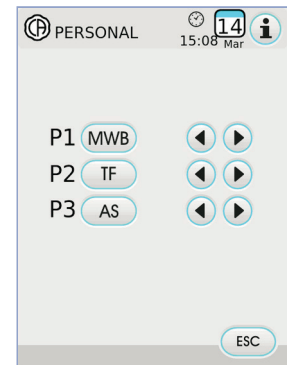
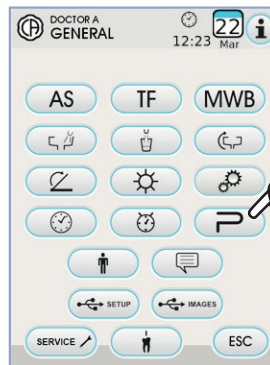







5.1.1.2.13. Operator data entry

From the GENERAL SETTINGS menu touch the icon button  to access the OPERATOR DATA ENTRY submenu.

 **NOTE:** the data modified always refers to the operator set on the main page.

- To enter the desired text, touch the icon buttons of the various letters (max. 20 characters).
- To enter capital letters, touch the icon button .
- To enter numbers or special characters, touch the icon button .
- To cancel any typing mistakes, touch the icon  button cancelling from left to right.
- Once you have entered the text, touch the icon button  to exit from the submenu and automatically save the data.
- Touch icon button  to quit the sub-menu without storing the changes.

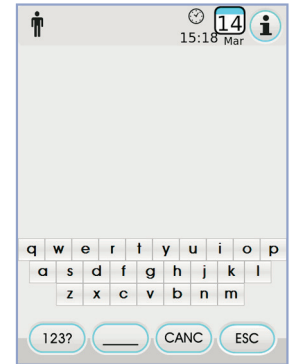
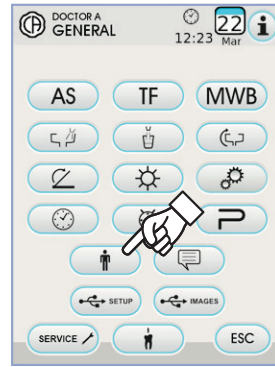

5.1.1.2.14. LANGUAGE selection

This setting is shared by all users.

From the GENERAL SETTINGS menu touch the icon button  to access the LANGUAGE SELECTION SUBMENU.

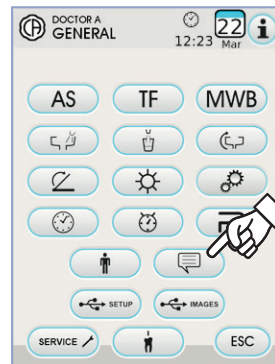

- To change the language, touch the icon button of the relative flag.
- To confirm the setting selected, exit this submenu by touching the icon button .



5.1.1.2.15. LAEC setting

This submenu allows setting the alarm threshold of the LAEC electronic apical locator (see paragraph 5.11).

From the GENERAL SETTINGS menu touch the icon button  to access the LAEC SETTING submenu.

- Set the alarm threshold using the icon button  or .
- An orange hyphen on the left-hand bar graph will show the value selected.

 **NOTE:** the settable value ranges from 0 to +2.

- Tapping the icon button  you can activate/deactivate the alarm signal when the set threshold is reached:

 alarm active.

 alarm inactive.

- To confirm the value selected, exit this submenu by touching the icon button .

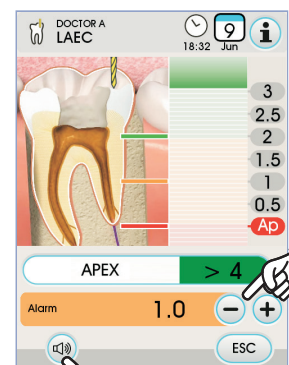



5.1.1.2.16. USB SETUP

The USB Setup page allows managing the following activities:

- Saving the current user profile to USB key,
- Loading a user profile from USB key for the "host" operator.

From the GENERAL SETTINGS menu touch the icon button  to access the USB SETUP submenu.

Operate as follows:

- Insert a USB key in the dedicated port on the dentist's console (see paragraph 5).
- Touch the icon button "Load" to load a "guest" user profile from the USB flash drive.

 **NOTE:** the "guest" profile will automatically be loaded to the fourth

operator position overwriting any existing profile.

- Touch the icon button "Save" to save the current user profile to the USB flash drive.

 **NOTE:** the settings of all the instruments on the dentist's instrument board, the chronometer, the lamp and the pedal unit will be saved.

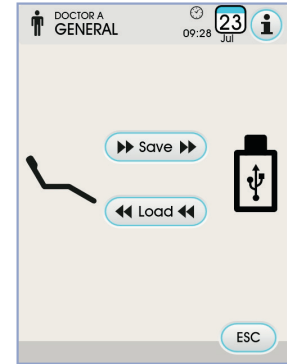
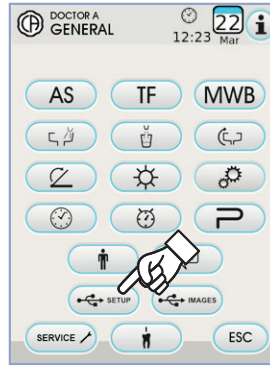

5.1.1.2.17. Image management



The dental image displaying and processing mode can be entered through the "Image management" screen.

The images present in the dental unit local memory or in a USB key can be managed and the MYRAY iRYS image management software can be interfaced with (see paragraph 5.1.1.2.16.1.).

PNG formats, both at 8 bit / pixel and at 16 bit / pixel, JPG or TIFF formats with resolutions between 640x480 and 2500x2500 pixels are supported.

Memory used.

According to the memory used, the following icons are displayed:

-  USB key connected.
-  PC connection through iRYS.
-  Local memory.

Changing the memory used.

The memory used can be changed as follows:

- Touch the icon in the top left corner of the display.
- Choose the desired memory.

 **NOTE:** the icon in the top left corner displays the currently used memory.

Operation with USB key.

Proceed as follows:

- Insert a USB flash drive inside the special port on the dentist's board console (see paragraph 5.).
- From the MAIN SETTINGS menu, touch icon  button to access the USB IMAGES sub-menu.

Flash drive contents will be scanned to show a list of folders .



 **NOTE:** the operation might require a few minutes to be completed, based on the size of the flash drive and on the number of images it contains.

 **NOTE:** while consulting the images, do not disconnect the USB flash drive.

"List" screen.

- Touch a folder to display the list of the images it contains.
- Touch the sidebar to scroll the image list.
- Touch the BACK element, always on top of the list, to go back to previous folder.

Available controls:

-  Display other available options
-  Create a new folder
-  Display the images contained inside current folder as thumbnails

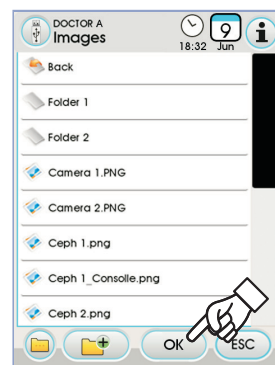
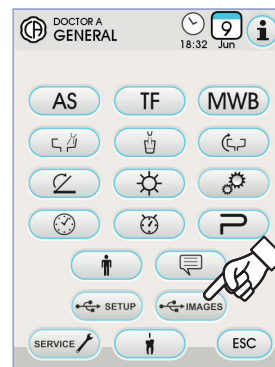
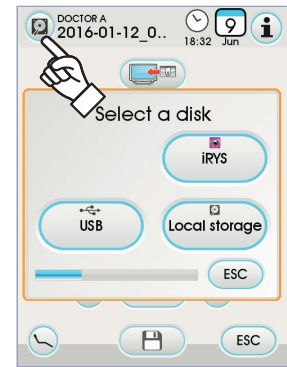
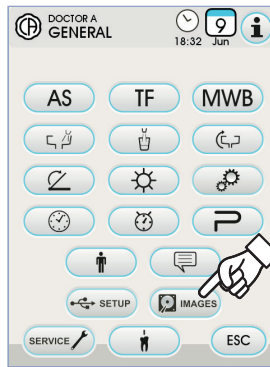



"Thumbnail" screen

- Scroll image thumbnails by touching on the left or on the right of the central image.
- Touch image to display it in full screen mode.
- Available controls:



Overturn image



Turn image clockwise



Recall main controls of main screen



Delete image
(a confirmation will be requested)



Go back to "list" screen



Display image on monitor
(only with monitor connected to camera module)

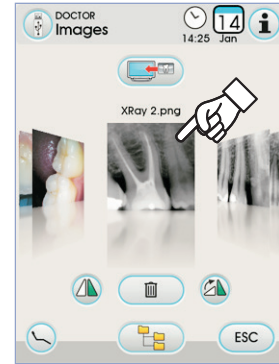

"Image" screen.

- Touch the image to zoom it and move it sideways.
- Available controls:



Image automatic improvement



Increase image brightness



Reduce image brightness



Restore image original appearance



Go back to "thumbnail" screen



NOTE: changes made to the image are automatically saved.

USB flash drive removal.

Before removing the USB flash drive, go back to main parameter menu or to other operative screens.

Operation with local memory.

The operation with local memory is the same as the operation with USB key.

5.1.1.2.17.1. Image management through iRYS

- From the MAIN SETTINGS menu, touch the icon button to access the iRYS patient archive.



NOTE: for correct PC connection, refer to the user's manual supplied with iRYS.



NOTE: the iRYS button is not shown when a USB key is connected.

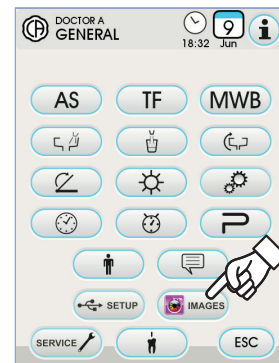





"List" screen.

- The "list" screen displays any patient folder open in iRYS and the last 3 patients consulted.
- Moreover, the following controls are available:

 **Search** Browse for a patient folder by entering the name.

 **Show all** Show all the available patient folders in alphabetical order.

 **NOTE:** the "Show All" button appears only if the total number of patients is lower than 100.





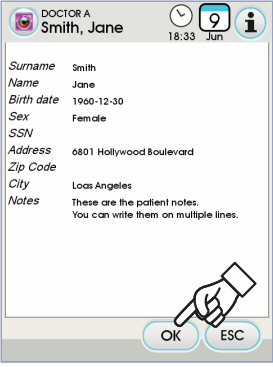
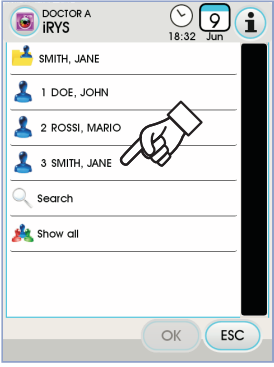

 **NOTE:** the console does not allow to create a new patient folder in iRYS.

- Select the desired patient - the corresponding general data sheet will be displayed in order to be checked.
- Touch icon button  to access the "thumbnail" screen.



"Thumbnail" screen.

- Scroll image thumbnails by touching on the left or on the right of the central image.
- Touch the image to display it in full screen mode.
- Available controls:

-  Overturn image
-  Turn image clockwise
-  Recall main controls of main screen
-  Load all the available images again in iRYS patient folder.
-  Go back to "list" screen
-  Display image on monitor (only with monitor connected to camera module)

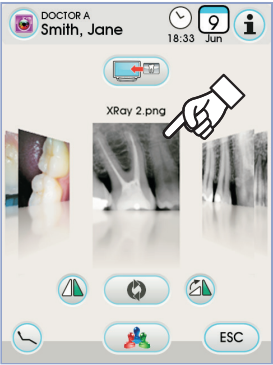





- Scroll image thumbnails by touching on the left or on the right of the central image.
- Touch the image to display it in full screen mode.

 **NOTE:** any image change performed from the console are NOT saved in iRYS.

"Image" screen.

- Touch the image to zoom it and move it sideways.
- Available controls:

-  Image automatic improvement
-  Increase image brightness
-  Reduce image brightness
-  Restore image original appearance
-  Go back to "thumbnail" screen



 **NOTE:** any image change performed from the console are NOT saved in iRYS.



5.1.2. Setting the dental chair's "rinse" and "home" positions

This setting is specific for each operator.

Perform the following operations from the main screen:

- Bring the dental chair into the desired position with the manual movements buttons.

NOTE: if the bowl is motor-driven, you can also store the bowl position.

- Activate storage mode by pressing the button for at least 2 seconds. Storage mode activation is signalled by a short beep and by the dedicated icon (**A**) on the TOUCH DISPLAY.

NOTE: Hold down button for at least 2 seconds to quit without saving the changes made.

- Press buttons "Automatic return" or "Rinse position" to assign the position to the button. The icon (**B**) referring to the program selected will appear on the TOUCH DISPLAY to confirm that it has been stored.

NOTE: The "Rinse position" button brings the backrest and seat into the rinse position.

When button "Rinse position" is pressed again, the backrest and seat return to the previous position.

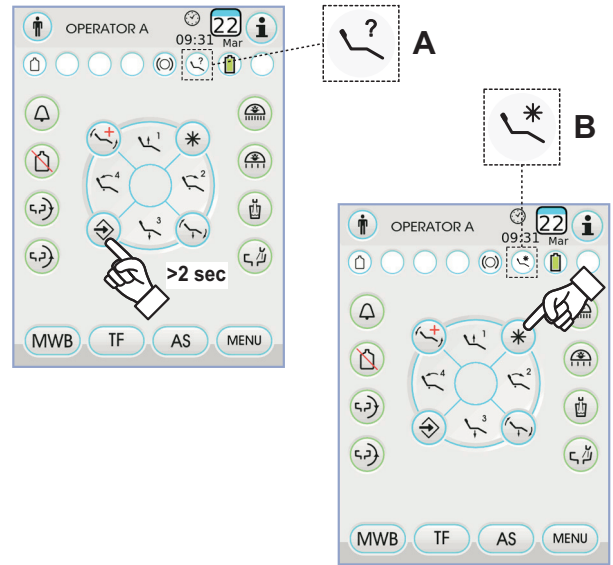

5.1.3. Programming the chair positions 1, 2, 3 and 4

This setting is specific for each operator.

Perform the following operations from the main screen:

- Bring the dental chair into the desired position with the manual movements buttons.

- Activate storage mode by pressing the button for at least 2 seconds.

NOTE: Storage mode activation is signalled by a short beep and by the dedicated icon (**A**) on the TOUCH DISPLAY.

- Push the 1, 2, 3 or 4 keys to associate the relevant position to the key (e.g. 3).

NOTE: The icon (**B**) referring to the program selected (e.g. 3) will appear on the TOUCH DISPLAY to confirm that it has been stored.

- NOTE:** To call up a set position simply briefly press the button assigned to the relative position.

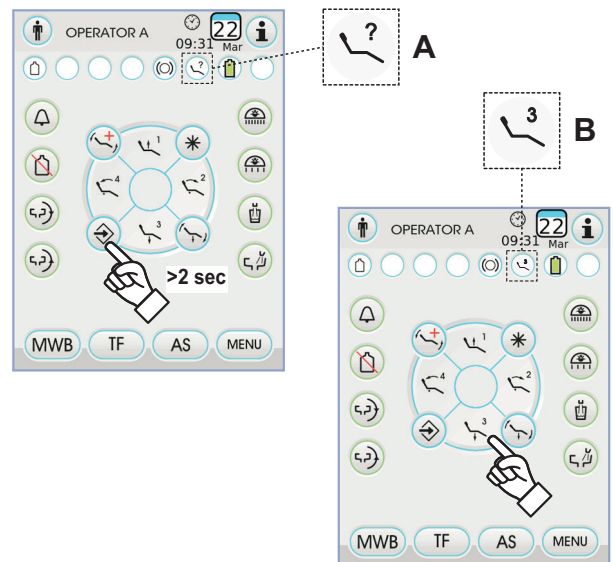



5.1.4. Emergency stop button

This button can be used in the event of an emergency to bring the patient into the Trendelenburg position.

NOTE: The Trendelenburg position is already set and cannot be changed.

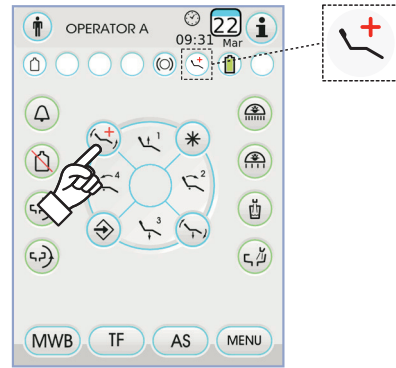

5.1.5. Button to reduce the operating lamp brightness

This button allows reducing the operating lamp brightness to a minimum.

NOTE: this function is active with VENUS PLUS -L light, only

NOTE: activation of reduced brightness mode is shown on the TOUCH DISPLAY by a dedicated icon (M).

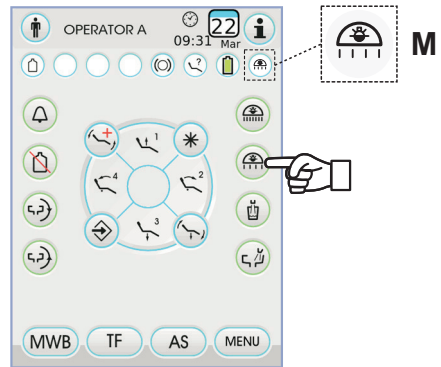

5.1.6. TOUCH screen disable button

This button allows enabling/disabling the TOUCH DISPLAY screen so that you can easily clean the console.

NOTE: The disabled status is indicated by a clear message on the TOUCH DISPLAY.

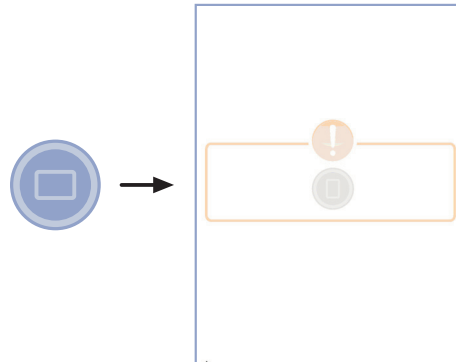



5.2. Foot control

There are 4 types of pantograph arm:

- ① "Multifunction" foot control (see paragraph 5.2.1)
- ② "Pressure operated" foot control (see paragraph 5.2.2)
- ③ "Power pedal" foot control (see paragraph 5.2.3)
- ④ "Lateral excursion" foot control (see paragraph 5.2.4)

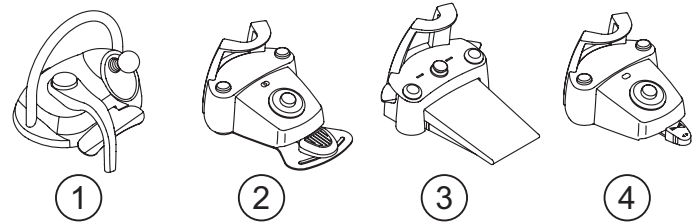

NOTE: the "lateral excursion" and "pressure operated" foot controls can also be supplied in the WIRELESS version (see paragraph 5.2.5).

5.2.1. "Multifunction" foot control

Description of the parts

- [1] Handle.
- [2] Horizontally actuated control lever.
- [3] Joystick for dental chair movements.
- [4] Vertically actuated control.

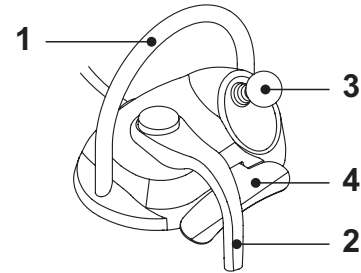

Control lever [2]

When the instruments are in place, the control lever [2] has 2 different operating modes, depending on whether or not the pedal [4] is pushed before hand.

NOTE: once the pedal [4] is pushed, the lever [2] must be actuated within 5 seconds. The function is automatically cancelled once this time has elapsed.

Operation with the instruments in place on the holder

- Lever [2] all the way to the right: dental operator light on/off

Operation with the instruments in place on the holder after pushing the pedal [4]

- Lever [2] all the way to the right: dental chair automatic return
- Lever [2] all the way to the left: patient rinse position retrieval. If the lever [2] is pushed all the way to the left, the dental chair reaches the work position.

NOTE: these dental chair functions are activated by holding down the pedal for at least 2 seconds.

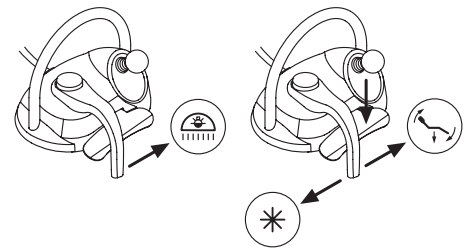

Operation with the instruments withdrawn

- Lever [2] to the right: starts the instrument and adjusts its speed/power.

NOTE: if the camera is withdrawn, the image is frozen.

- Lever [2] all the way to the left: CHIP-AIR for the turbine or the micromotor is started.

The air jet is stopped when the lever [2] is released.

NOTE: if the camera is withdrawn, the saved images can be selected one after the other.

- Hold down the pedal [4] to start the CHIP-WATER for the turbine, micromotor or scaler.

The water jet is stopped when the pedal [4] is released.

NOTE: if the camera is withdrawn, full-screen display of the selected image is activated/deactivated.

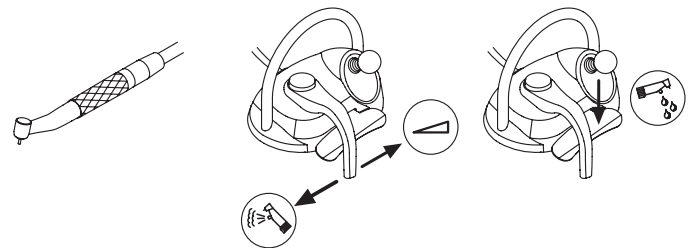

Water spray to instruments on/off

The spray is delivered by holding down the pedal [4] when the instrument is turned on (lever [2] activated).

NOTE: the type of spray delivered can be set from the doctor's console.

NOTE: you can set the foot control in such a way that the control [4] sets instrument spray activation or deactivation before you operate the lever [2] (bistable operation).

Only a CASTELLINI authorized technician can set the foot control in this manner.

NOTE: at the end of work a blast of air is automatically activated to eliminate any residual drops of liquid in the instrument ducts.

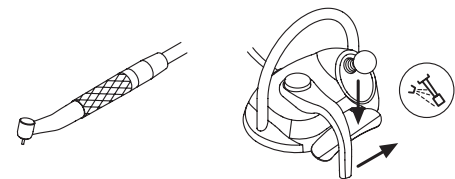



Joystick for dental chair movements [3]

The joystick for dental chair movements [3] has 2 different operating modes, depending on whether or not the pedal [4] is pushed before hand.

NOTE: once the pedal [4] is pushed, the joystick [3] must be actuated within 5 seconds. The function is automatically cancelled once this time has elapsed.

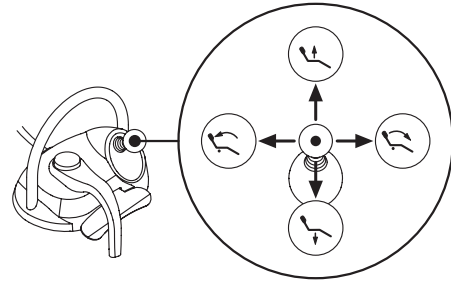

Operation with the instruments in place on the holder

The joystick [3] actuates the 4 manual dental chair movements.

NOTE: release the joystick to stop manual movement.

Operation with the instruments in place on the holder after pushing the pedal [4]

The joystick [3] retrieves the 4 dental chair programs.

NOTE: actuate the joystick again to stop automatic movement.

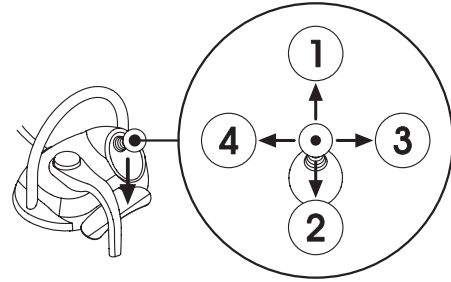

With instrument withdrawn but not turned on

The joystick [3] actuates the 4 manual dental chair movements.

NOTE: the 4 programs are blocked under this condition.

With instrument turned on (lever [2] actuated)

Joystick disabled, all the commands to move the dental chair are blocked.

Foot control setup.

The foot control has 4 different configurations identified as 0, 1, 2 and 3:

0 = Joystick for only direction operation of the dental chair

1 = Auxiliary equipment and dental chair controllers (default configuration)

2 = ENDO mode and micromotor reverse rotation

3 = Surgical mode

Operation in the various configurations is explained below.

NOTE: the configuration of the foot control can be changed only by a CASTELLINI authorized technician.

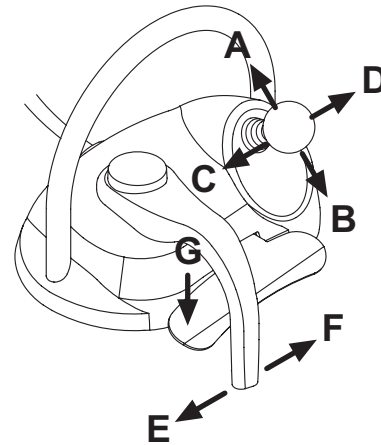

Dental chair movements (instruments in place)		CONFIGURATIONS			
ACTIVATION	FUNCTION	0	1	2	3
A	Up	X	X	X	X
B	Down	X	X	X	X
C	Back up	X	X	X	X
D	Back down	X	X	X	X

Automatic dental chair movements (instruments in place)		CONFIGURATIONS			
ACTIVATION	FUNCTION	0	1	2	3
G + A	Position 1 retrieval		X	X	X
G + B	Position 3 call up		X	X	X
G + C	Position 2 call up		X	X	X
G + D	Position 4 retrieval		X	X	X
G + E	Rinse position retrieval		X	X	X
G + F (End stop)	Reset position retrieval		X	X	X

Auxiliary equipment (instruments in place)		CONFIGURATIONS			
ACTIVATION	FUNCTION	0	1	2	3
F (End stop)	Dental operating light: on / off		X	X	X



Instruments (instruments withdrawn)		CONFIGURATIONS			
ACTIVATION	FUNCTION	0	1	2	3
F	Activation and/or speed/power adjustment	X	X	X	X
F e G	Startup with Spray	X	X	X	X
G	Scaler: start at max power Camera: image freeze	X	X	X	X
C	Micromotor: reverse rotation			X	X
D	Micromotor and Scaler: ENDO function			X	
A B D	Instrument menu navigation (surgical mode)				X
E	Activation with Chip-Air	X	X	X	X

Instrument menu navigation (surgical mode)		CONFIGURATIONS			
ACTIVATION	FUNCTION	0	1	2	3
A	INCREASE value (+)				X
B	DECREASE value (-)				X
C	Micromotor: reverse rotation				X
D	Micromotor: work programs M1, M2, M3 and M4 selection				X

Protection against liquid penetration.

The foot control is protected against liquid penetration. Degree of protection: IPX1.

Cleaning

Clean the foot control using a suitable product (see Paragraph 1.4).

5.2.2. "Push-pedal" foot control

Description of the parts

- 1 Handle
- 2 Control pedal
- 3 Dental chair movements
- 4 Chip-air/patient rinsing position control.
- 5 Water Clean System/Automatic dental chair return control.
- 6 Spray operation LED
- 7 Battery charge LED (wireless version only).

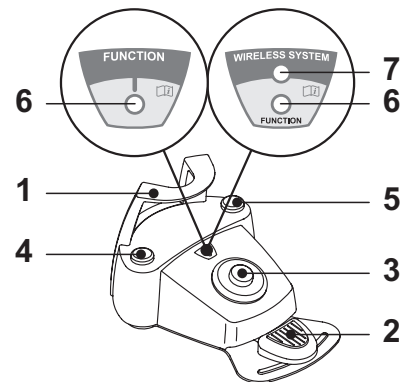

Control pedal (2)

Operation:

- Remove the instrument
- Push the foot pedal to start the instrument (a)
- Adjust the rpm/power of the instrument with the control pedal:
 - to right: to increase
 - to left: to decrease

NOTE: the control pedal adjusts the speed/power of the instrument from the minimum to the maximum value set from the instrument board.

- To stop the instrument, simply release the control pedal (a).

NOTE: with the spray active, at the end of the operation a blast of air is automatically activated to remove any residual drops of liquid in the spray ducts.

WARNING!

Instrument spray is activated and deactivated by pressing the buttons (4) or (5).

A beep sounds to signal the operating status has been changed.



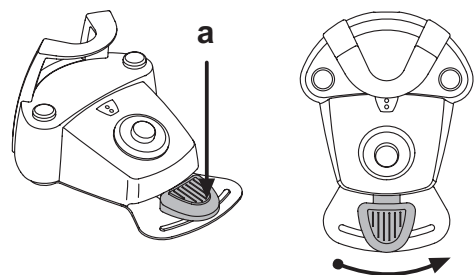

When the LED (6) is on, it indicates operation with spray.





Joystick for dental chair movement (3).

These buttons move the dental chair as follows:

-  Dental chair seat up.
-  Dental chair backrest up.
-  Dental chair seat down.
-  Dental chair backrest down.

To stop the chair movement, release the joystick.

NOTE: All the buttons used to move the dental chair are inoperative when an instrument is removed and the foot control pedal is actuated.

NOTE: the joystick operating mode can be changed with the instrument removed (see Paragraph 5.1.1.2.7.).

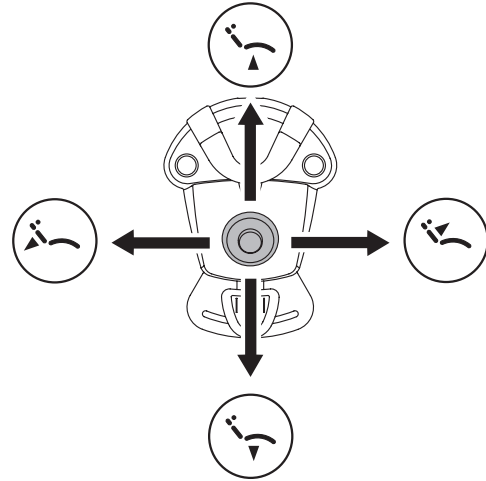

Left-hand button operation (4).

Operation:

- Holding down the button for at least 2 seconds with the instruments in rest position:

Activation of the “Patient rinsing position” program.

NOTE: Pressing the button a second time returns the dental chair into working position.

- Holding down the button for at least 2 seconds with instrument extracted:

Chip-air control: sends a jet of air to the turbine or the micromotor. Air delivery is activated by pressing the button; the jet of air is interrupted when the button is released.

NOTE: The control works only when the turbine and micromotor are in working position.

- Briefly pressing the button with the instrument extracted:

Activation or deactivation of instrument spray.



WARNING!

A short acoustic signal warns of the switch.

When the LED (6) is on, it indicates operation with spray.

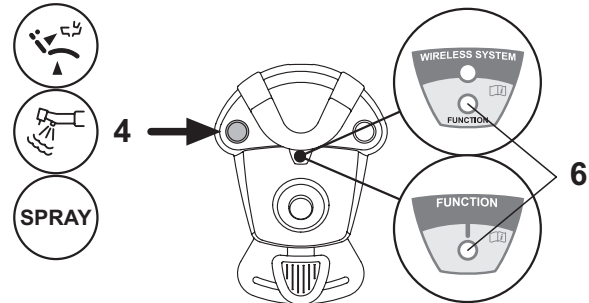

Right-hand button operation (5).

Operation:

- Holding down the button for at least 2 seconds with the instruments in rest position:

Activation of the “Automatic dental chair return” program.

- Holding down the button for at least 2 seconds with instrument extracted:

Water Clean System control: sends a jet of running water to instruments such as the turbine, the micromotor and the scaler for rinsing the spray ducts.

Water delivery is activated by pressing the button (4); when the button is released, the jet of water is interrupted and a blast of air is automatically activated to remove any residual drops of liquid in the spray ducts.

- Briefly pressing the button with the instrument extracted:

Activation or deactivation of instrument spray.



WARNING!

A short acoustic signal warns of the switch.

When the LED (6) is on, it indicates operation with spray.

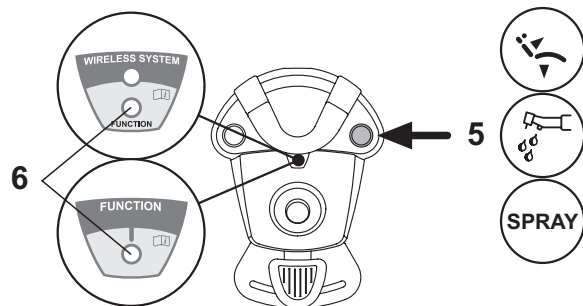

Wireless version.

This foot control can also be supplied in wireless version (see Paragraph 5.2.4).

Protection against liquid penetration.

The foot control is protected against liquid penetration. Degree of protection: IPX1.

Cleaning.

Clean the foot control using a suitable product (see Paragraph 1.4).

NOTE: if the foot control slips on the floor, dust the slip-proof rubber found under the base with a dry cloth.

5.2.3. "Power Pedal" foot control

Description of the parts.

- 1 Handle.
- 2 Foot control.
- 3 Dental chair movements.
- 4 Chip-air control or activation/deactivation of instrument spray function.
- 5 Water Clean System control or activation/deactivation of instrument spray function.
- 6 Automatic dental chair return or programme "B" recall activation.
- 7 Patient rinse position or programme "A" recall activation.
- 8 Spray operation LED.

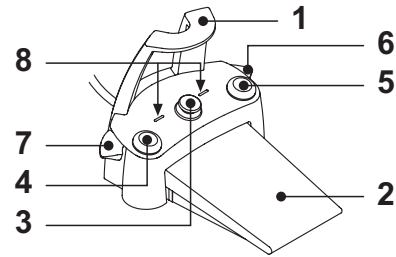

Foot control operation (2).

• With instrument removed

- Pushing the pedal (a), the instrument is started.
The instrument's rpm (or power) can be adjusted by varying the pressure exerted on the foot control.

NOTE: the foot control adjusts the speed/power of the instrument from the minimum to maximum value set from the instrument board.

- Release the foot control to stop instrument operation.

NOTE: with the spray active, at the end of the operation a blast of air is automatically activated to remove any residual drops of liquid in the spray ducts.

• With instrument in place

When the foot control is pressed, all automatic dental chair movements are automatically blocked.

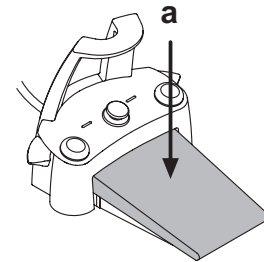

Joystick for dental chair movement (3).

These buttons move the dental chair as follows:



Dental chair seat up.



Dental chair backrest up.



Dental chair seat down.



Dental chair backrest down.

To stop movement, release the button.

NOTE: all dental chair movements are blocked when an instrument is being used or the AUTOSTERIL system is running.

NOTE: the joystick operating mode can be changed with the instrument removed (see Paragraph 5.1.1.2.7.).

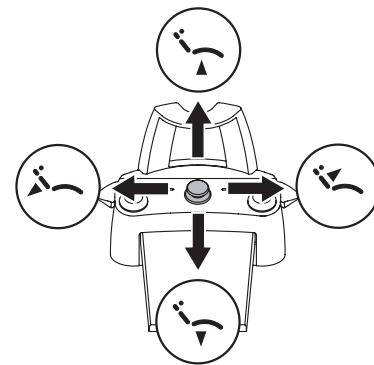

Left-hand button operation (4).

• Holding down the button for at least 2 seconds with instrument extracted:

Chip-air control: sends a jet of air to the turbine or the micromotor. Air delivery is activated by pressing the button; the jet of air is interrupted when the button is released.

• Briefly pressing the button with the instrument extracted:

Activation or deactivation of instrument spray.



WARNING!

A short acoustic signal warns of the switch.

When the LED (8) is on, it indicates operation with spray.

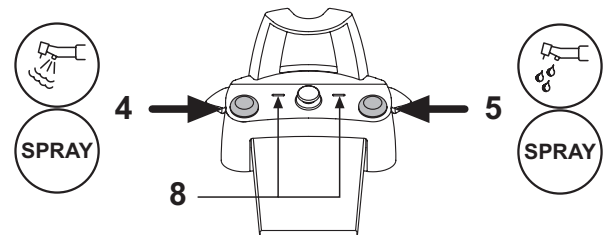

Right-hand button operation (5).

• Holding down the button for at least 2 seconds with instrument extracted:

Water Clean System control: sends a jet of running water to instruments such as the turbine, the micromotor and the scaler for rinsing the spray ducts. Water delivery is activated by pressing the button (5); when the button is released, the jet of water is interrupted and a blast of air is automatically activated to remove any residual drops of liquid in the spray ducts.

• Briefly pressing the button with the instrument extracted:

Activation or deactivation of instrument spray.



WARNING!

A short acoustic signal warns of the switch.

When the LEDs (8) are on, they indicate operation with spray.



Right lever operation (6).

NOTE: the lever functions only with the instruments in their rest position.

For safety reasons, the selected function starts only after the switch has been briefly actuated and then released.

• **Lever pushed down:**

"Dental chair automatic return" program activated.

• **Lever pulled up:**

Dental chair program "B" start.

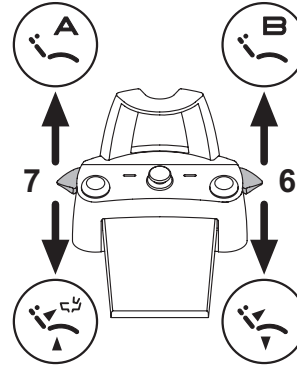

Left lever operation (7).

NOTE: the lever functions only with the instruments in their rest position.

For safety reasons, the selected function starts only after the switch has been briefly actuated and then released.

• **Lever pushed down:**

"Rinse position" (PR) program activated

NOTE: when the switch is actuated the second time, the dental chair reaches its work position.

• **Lever pulled up:**

Dental chair program "A" start.

Protection against liquid penetration.

The foot control is protected against liquid penetration.

Degree of protection: IPX1.

Cleaning.

Clean the foot control using a suitable product (see Paragraph 1.4).

NOTE: if the foot control slips on the floor, dust the slip-proof rubber found under the base with a dry cloth.

5.2.4. "Lateral excursion" foot control

Description of the parts.

- 1 Handle
- 2 Control pedal
- 3 Dental chair movements
- 4 Chip-air/patient rinsing position control.
- 5 Water Clean System/Automatic dental chair return control.
- 6 LED (not active).
- 7 Battery charge LED (wireless version only).

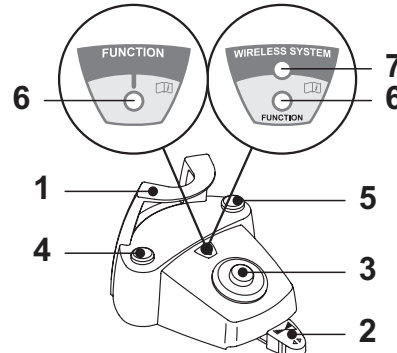

Control pedal (2).

With instrument removed

- Starts the instrument.
- Adjusts the rpm of rotary instruments.
- To right: operation with spray (if foreseen for selected instrument).

NOTE: At the end of work, air is automatically blown to eliminate any drops of liquid remaining in the spray ducts.

- To left: spray-free operation

With instruments in place

- Fully right: dental chair automatic return (RA).
- Fully left: patient rinse position reached (PR).

NOTE: If the pedal is pushed fully left again, the dental chair moves back to the work position.

WARNING!

These dental chair functions are activated by keeping the pedal at the end of the travel for at least 2 seconds.

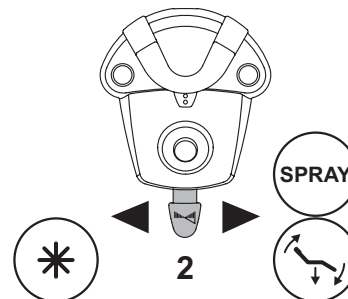





Controller joystick for dental chair movement (3)

These buttons move the dental chair as follows:

- Dental chair seat up.
- Dental chair backrest up.
- Dental chair seat down.
- Dental chair backrest down.

To stop the chair movement, release the joystick.

 **NOTE:** all the buttons used to move the dental chair are inoperative when an instrument is removed and the foot control pedal is actuated.

 **NOTE:** the joystick operating mode can be changed with the instrument removed (see Paragraph 5.1.1.2.7.).

Left-hand button operation (4)

- Key held down (at least 2 seconds) with the instrument removed:

Chip-air operation: delivers air to the turbine or micromotor.

Air is delivered by pressing the button. Air is no longer blown when the button is released.

- Key held down (at least 2 seconds) with the instruments in place:

"Rinse position" (PR) program activated.

 **NOTE:** Press the key again to bring the chair back to the work position.

Right-hand button operation (5)

- Key held down (at least 2 seconds) with the instrument removed:

Water Clean System operation: running water is sent to the instruments such as the turbine, micromotor and scaler to flush the spray ducts.

Water is delivered by pressing the button. Water is no longer delivered when the button is released and air is automatically blown to eliminate any drops of liquid remaining in the spray ducts.

- Key held down (at least 2 seconds) with the instruments in place:

"Dental chair automatic return" program activated.

Wireless version.

This foot control can also be supplied in wireless version (see Paragraph 5.2.5).

Protection against liquid penetration.

The foot control is protected against liquid penetration. Degree of protection: IPX1.

Cleaning.

Clean the foot control using a suitable product (see Paragraph 1.4).

 **NOTE:** If the foot control slips on the floor, dust the slip-proof rubber found under the base with a dry cloth.

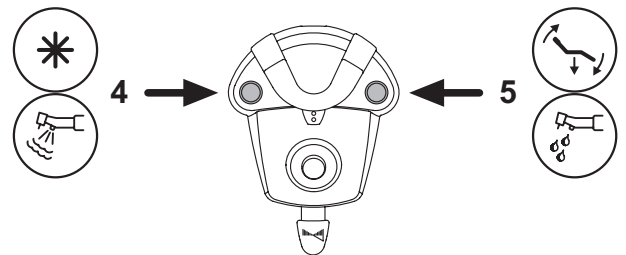
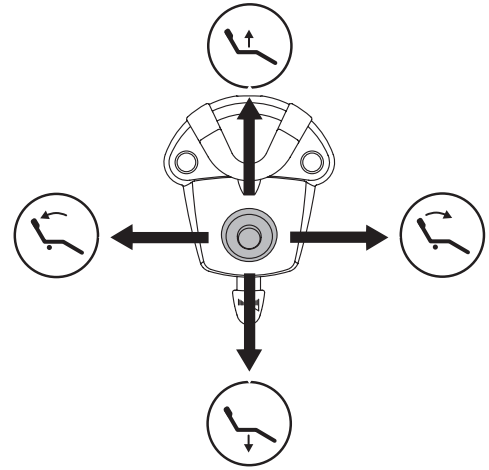



5.2.5. Wireless foot control

The “lateral excursion” and “pressure operated” foot controls can also be supplied in the WIRELESS version. The wireless foot control contains a ZIGBEE transmitter module (module certified for Europe, Canada and the USA).

Warnings for use.



- **Avoid keeping the wireless foot control in proximity of other RF sources, such as wireless LAN cards, other radio devices, home RF devices, microwave ovens. The recommended distance is at least 2 metres in the case of microwave ovens and 1 metre in all other cases.**
- **Even though the electromagnetic field irradiated by the foot control is insignificant, it is advisable NOT to use it in proximity of life support equipment (e.g. pacemakers or heart stimulators) and hearing aids. Before using any electronic device in health facilities, always ascertain that it is compatible with the other equipment present.**
- **Exclusively use the dental unit to charge the battery of the WIRELESS foot control.**
- **The internal battery may only be replaced by a qualified technician.**

Warnings for first use.

It is advisable to fully charge the foot control battery before using it for the first time.

WIRELESS foot control operation.

The WIRELESS foot control operates in exactly the same way as the wired version, therefore refer to the paragraphs above paying attention to the specific model used.

In addition, the WIRELESS foot control has a specific LED (7) that indicates the battery charge and the communication status with the dental unit.

LED (7) indications.

The colour of the LED indicates the battery charge, while the type of flashing indicates the communication status with the dental unit.

Battery charge:

COLOUR	DESCRIPTION (CABLE DISCONNECTED)	DESCRIPTION (CABLE CONNECTED)
GREEN	Battery charge (>75%)	Battery charged
ORANGE	Battery charge (<50%)	Battery charging
RED	Battery needs charging (<25%)	Battery charge error
Off	Battery flat	Dental unit off or foot control fault

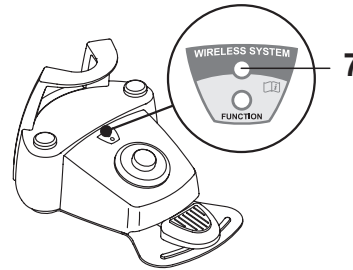

Communication status:

FLASHING	DESCRIPTION
Slow	Connection active in wireless mode
Fast	Connection active with charging cable inserted
Double	Connection search
On fixed	Communication error

NOTE: this information can be shown also on the TOUCH DISPLAY through the specially provided icons (A) or (B) (see paragraph 5.1.) or in the specially provided control menu of the foot control (see paragraph 5.1.1.2.3.).

Battery characteristics.

The WIRELESS foot control is equipped with a rechargeable Lithium-Polymer battery (Li-Poly, 3.7V, 5200 mAh type Guangzhou Markyn Battery Co. Model 9051109).

The battery life is approximately 2 months (estimating 8 hours of consecutive daily operation) with the battery fully charged and fully efficient. The battery efficiency reduces with age. It is estimated that the efficiency is reduced to 60% after 500 complete recharging cycles. Also in this condition, the battery should last about 1 month.

NOTE: When the battery efficiency is so far reduced as to be deemed unsatisfactory to support the daily usage requirements, have it replaced by a qualified technician (original spare part no. 97901336).



Do not attempt to replace the battery yourself.

Limited battery warranty.

The battery in the foot control is covered by a 6-month warranty from the date of installation.

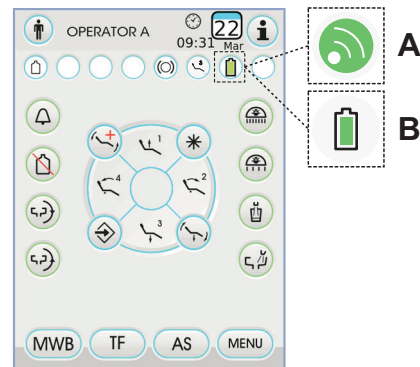



Recharging the battery.

When the batteries in the WIRELESS foot control need to be recharged, operate as follows:

- Open the protective cap of the connector on the rear of the foot control and connect the recharging cable.
- Connect the other end of the recharging cable to the dental unit (see figure).

At this point, the foot control, while it remains fully operational, will start recharging the battery (Battery charging warning LED on).

 **NOTE:** The battery is fully recharged in about 6 hours.



WARNING!

Exclusively use the dental unit to charge the battery of the WIRELESS foot control.

Natural battery discharge.

Should the battery not be used for long periods of time, it may slowly discharge all the same.

After long periods of disuse, it is advisable to always fully charge the battery before use.

Maintenance and disposal

The wireless foot control does not contain parts that can be repaired directly by the user.

In the event of a malfunction, do not attempt to carry out maintenance operations, but directly contact the manufacturer or his local distributor at the numbers indicated in the warranty certificate.

At the end of its lifetime, the battery must be replaced by a specialised technician at a Service Centre.

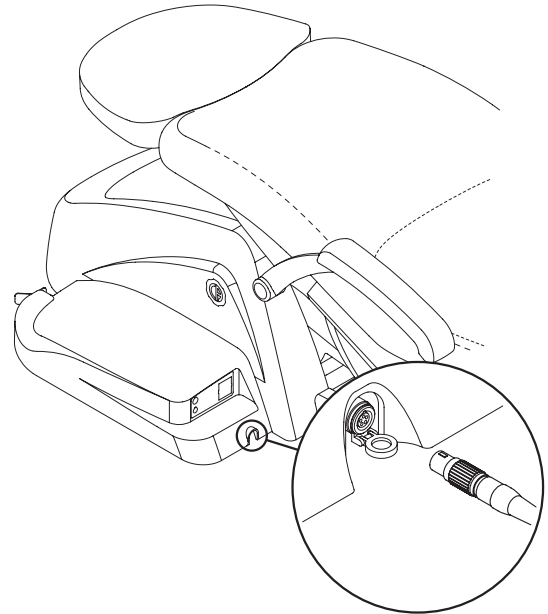
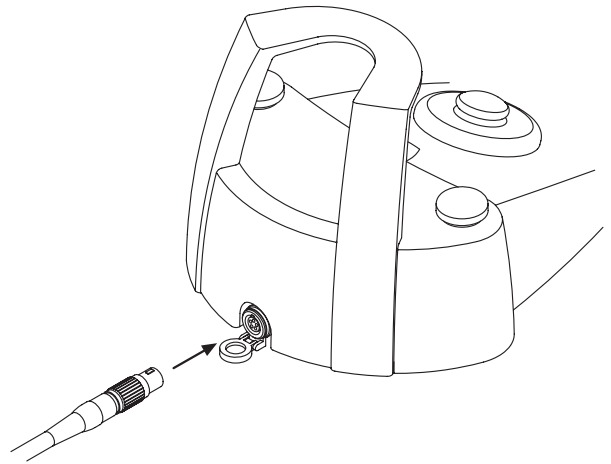



5.3. Syringe

Description of the instrument.

- [a] Nozzle.
- [b] Handpiece.
- [c] Syringe release button.
- [d] Air button.
- [e] Water button.
- [f] Hot/cold selector.
- [g] Hot/cold indicator light.

! WARNING!

The instrument is supplied non-sterile.
It is recommended to use single-use protections and nozzles.

Technical characteristics.

- Operating time:
 - 3F syringe: continuous operation,
 - 6F syringe: 5 sec. operation, 10 sec. rest.
- Power supply:
 - 6F and 6F-L syringe (CEFLA models): 24 Vac; 50/60 Hz; 2 A; 50 W.
- Classification in accordance with standard EN 60601-1:
 - 6F and 6F-L syringe (CEFLA models): CLASS II, type B.
- Installation plan: consult the Technical Installation Manual (see Paragraph 11.).

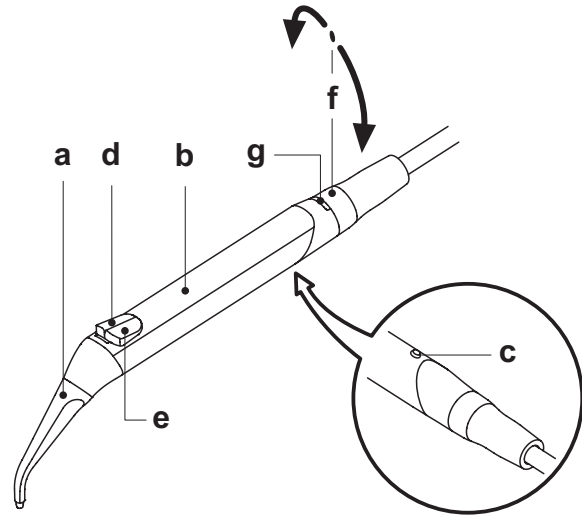

Operation.



- Place the instrument in its work position.

NOTE: instrument activation is indicated by the relative management page appearing on the TOUCH DISPLAY.

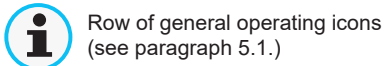
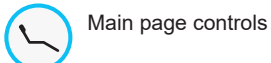
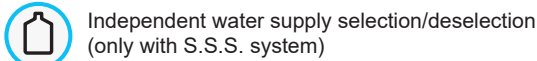
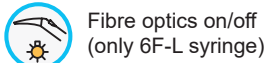
- Button [e] = water;
- Button [d] = air;
- Buttons [e + d] = spray.
- 6F syringe, operation with hot water, air and spray: turn the selector [f] clockwise (LED g on).
- 6F syringe, operation with cold water, air and spray: turn the selector [f] anticlockwise (LED g off).
- The icon buttons available on the TOUCH DISPLAY are the following:



Fibre optic brightness adjustment.

- Set the instrument to its work position.
- Activate the optical fibre by pushing the OPTICAL FIBRES key.
- To adjust the fibre optic brightness, touch and hold (for at least 2 seconds) the icon button .
- Adjust the brightness by touching the icon buttons  or .

NOTE: the settable value ranges from 1 to 16.

- To confirm the brightness selected, exit this submenu by touching the icon button .

NOTE: after 30 seconds the fibre optics turns off automatically.

Removing the handpiece.

- The nozzle (a) is screwed onto the grip (b).
- Turn the selector switch counter-clockwise (LED g off) and press the button (c) to take the grip off the syringe casing.

Removable syringe cord

The syringe has a removable cord to ease cleaning (see chapter 5).

Cleaning.

Use soft disposable paper towel dampened with detergents/disinfectants.

! WARNING!

- Do not soak the syringe in liquid disinfectants or detergents.
- Products not recommended: harsh products and/or products containing acetone, chlorine and sodium hypochlorites.

Disinfection.

Syringe grip and spout: steam autoclave up to 135°C following the instructions for use of the device.

NOTE: Bag before sterilizing.

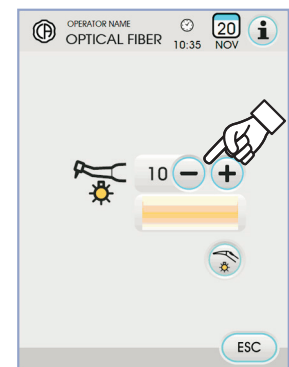



5.4. Turbine

Connecting the handpiece and changing the chuck.
Refer to the specific instructions furnished with the handpiece.

Use.



WARNING!

Read the instructions for use of the various turbines.

- The cock (f) adjusts the water flow to the spray.
- The cock (e) adjusts the amount of air spray for all the instruments.
- Place the instrument in its work position.



NOTE: instrument activation is indicated by the relative management page appearing on the TOUCH DISPLAY.

- The icon buttons available on the TOUCH DISPLAY are the following:



Settable value increase



Settable value decrease



Turbine rotation speed selection



Fibre optics on/off



Independent water supply selection/deselection (only with S.S.S. system)



Instrument spray type enable and selection



Main page controls



Row of general operating icons (see paragraph 5.1.)

MIN

Quick selection of power at 1% of the maximum turbine rotation speed

MED

Quick selection of power at 50% of the maximum turbine rotation speed

MAX

Quick selection of power at 100% of the maximum turbine rotation speed



ON

Peristaltic pump activation/deactivation (only if present).

- Use the foot control pedal to start the instrument (see paragraph 5.2).



NOTE: The turbine cord can also be used to connect the air micro-motors equipped with 4-way connector and conform to ISO 13294 - Dental Air Motor.



WARNING!

The instrument is supplied non-sterile.

Fibre optic brightness adjustment.

- To adjust the fibre optic brightness, touch and hold (for at least 2 seconds) the icon button
- Adjust the brightness by touching the icon or .



NOTE: the settable value ranges from 1 to 16.

- To confirm the brightness selected, exit this submenu by touching the icon button **ESC**.



NOTE: after 30 seconds of not using the instrument (foot control lever deactivated), the fibre optics turns off.

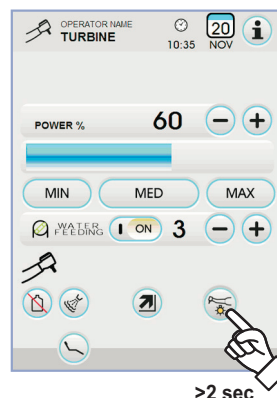
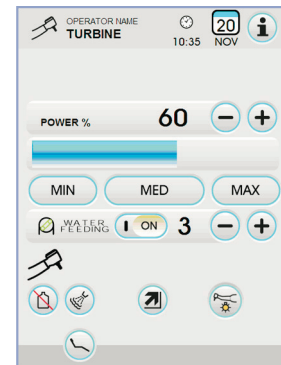
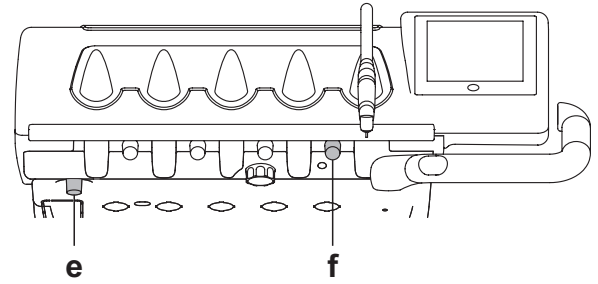

>2 sec

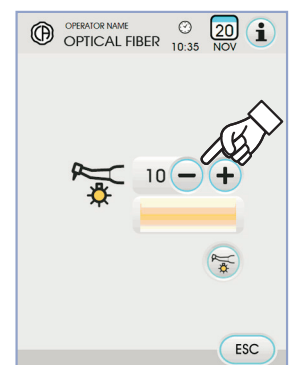



Turbine rotation speed change.

With the instrument in working position, select turbine speed change mode by touching the following icon buttons:



Linear change proportional to the movement of the foot control lever



ON/OFF change that results in delivery of the maximum power set upon activation of the foot control lever

The active mode icon is shown on the TOUCH DISPLAY.

NOTE: the data is automatically stored.

Instrument spray control button.

With the instrument in working position, select the type of spray delivered by the instrument by touching the following icon buttons:



Water + air spray operation



Water-only spray operation



Operation without spray

The change is cyclic each time the button is touched and the active mode icon is shown on the TOUCH DISPLAY.

NOTE: the data is automatically stored.

Peristaltic pump activation/deactivation (only if present).

To activate/deactivate the peristaltic pump, touch the relative icon button:



Peristaltic pump inactive



Peristaltic pump active

NOTE: activation is shown in the box next to the value of the physiological saline solution delivered.

Push the icon buttons **-** or **+** to modify the quantity of physiological saline solution delivered by the peristaltic pump.

NOTE: the settable value ranges from 1 to 5. The quantity of delivered solution associated with the settable values is the following:

- value 1: approx. 35 cc/min,
- value 2: approx. 50 cc/min,
- value 3: approx. 70 cc/min,
- value 4: approx. 90 cc/min,
- value 5: approx. 100 cc/min.

NOTE: You can change the amount of saline solution delivered by the peristaltic pump also when the instrument is active.

Removable cord.

The turbine has a removable cord to ease cleaning (see paragraph 5.).

Cleaning and care.

Refer to the specific instructions furnished with the handpiece.

It is recommended to use Daily Oil (CEFLA s.c.) for lubrication.

Disinfection.

Steam autoclave up to 135°C following the instructions for use of the device.



WARNING!

Carefully read the operating instructions supplied with the handpiece before attempting to sterilize.

Safety guidelines.



WARNING!

The turbine must never be started without attaching the chuck or false chuck.

The chuck release button must be held down during operation!

Friction between the button and micromotor rotor overheats the head and may cause burns.

The patient's internal tissues (tongue, cheeks, lips, etc...) must be protected against contact with the button by using suitable instruments (mirror, etc...).

The chucks and various instruments attached to the handpieces must comply to the standard ISO 10993-1 Biological evaluation of medical devices.

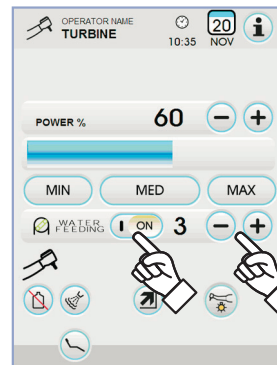
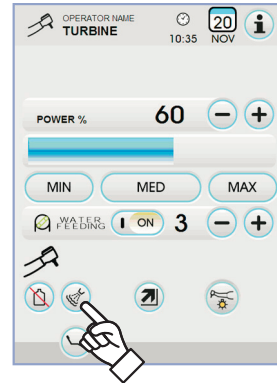
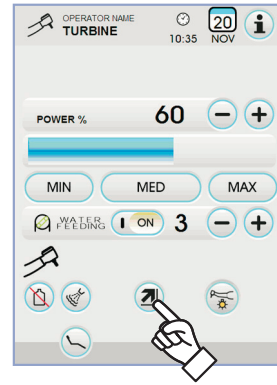



5.5. Micromotor

Coupling the handpieces and changing the chuck.

Refer to the specific instructions furnished with the micromotor and various handpieces.

Use.



WARNING!

Also read the instructions for use of the various motors.

The instrument is supplied non-sterile.

- Operating time: work 5 min., rest 5 min.
- The cock (f) adjusts the water flow to the spray.
- The cock (e) adjusts the amount of air spray for all the instruments.
- Place the instrument in its work position.



NOTE: instrument activation is indicated by the relative management page appearing on the TOUCH DISPLAY.

- The main icon buttons available on the TOUCH DISPLAY are the following:



Settable value increase



Settable value decrease



Reduction ratio selection



Reduction ratio selection



Speed change mode selection



Selection of micromotor drill rotation direction



Alarm signal activation/deactivation



Reduction ratio setting (see paragraph 5.5.4.)



Fibre optics on/off



Independent water supply selection/deselection (only with S.S.S. system)



Instrument spray type enable and selection

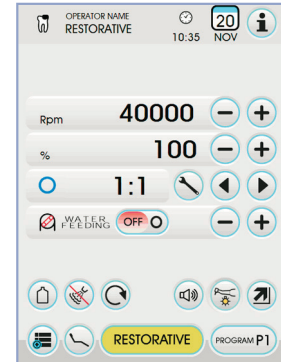
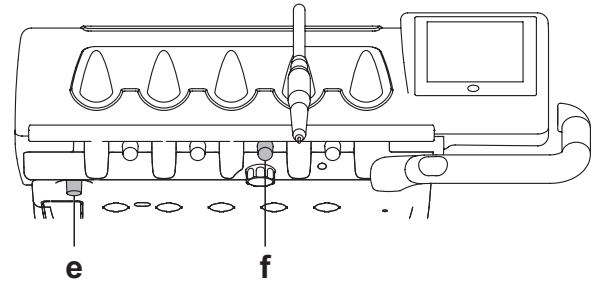

Main page controls



Row of general operating icons (see paragraph 5.1.)



Simplified menu display



Peristaltic pump activation/deactivation (only if present)



Micromotor operating mode selection



Micromotor operating program selection

- Use the foot control pedal to start the instrument (see paragraph 5.2).

Fibre optic brightness adjustment.

- To adjust the fibre optic brightness, touch and hold (for at least 2 seconds) the icon button
- Adjust the brightness by touching the icon buttons or .



NOTE: the settable value ranges from 1 to 16.

- To confirm the brightness selected, exit this submenu by touching the icon button .



NOTE: after 30 seconds of not using the instrument (foot control lever deactivated), the fibre optics turns off.

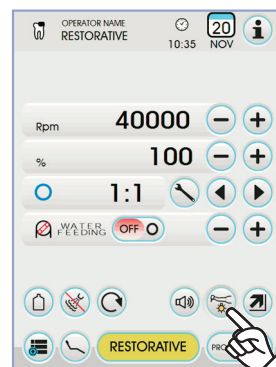

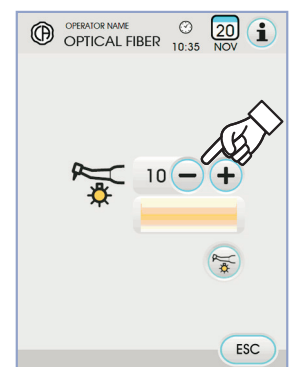

>2 sec





Instrument spray control button.

With the instrument in working position, select the type of spray delivered by the instrument by touching the following icon buttons:



-  Water + air spray operation
-  Water-only spray operation
-  Operation without spray

The change is cyclic each time the button is touched and the active mode icon is shown on the TOUCH DISPLAY.

 **NOTE:** the data is automatically stored.

Rotation speed change mode selection.

With the instrument in working position, select rotation speed change mode by touching the following icon buttons:



-  Linear change proportional to the movement of the foot control lever
-  ON/OFF change that results in delivery of the maximum power set upon activation of the foot control lever

The active mode icon is shown on the TOUCH DISPLAY.

 **NOTE:** the data is automatically stored.

Reversing micromotor drill rotation direction.

Select micromotor drill rotation direction by touching the relevant icon button:

-  Normal rotation direction
-  Inverted rotation direction

Inverted rotation direction is signalled by 3 beeps.





 **WARNING!**

Subsequently, when the micromotor is extracted, 3 warning beeps are emitted if the rotation direction is inverted.

 **NOTE:** when the rheostat lever is on, the micromotor drill cannot reverse its direction of rotation.

Micromotor operating mode selection.

The micromotor has 4 different operating modes that can be selected by touching the relevant icon button:

-  **RESTORATIVE** mode (see paragraph 5.5.1.)
-  **ENDODONTIC** mode (see paragraph 5.5.2.)
-  **IMPLANT** mode (see paragraph 5.5.3.)
-  **RECIPROCATING MODE** (see paragraph 5.5.5.)

 **NOTE:** the change occurs cyclically.

Micromotor operating program selection.

The micromotor has 4 operating programs identified with P1, P2, P3, P4 that can be selected by touching the relative icon button.

Each operating program stores the following data:

- operating mode
- maximum rotation speed / torque value
- fibre optics ON/OFF
- fibre optic brightness
- rotation direction inversion ON/OFF
- type of spray delivered
- Peristaltic pump (if present) ON/OFF
- Handpiece reduction ratio.

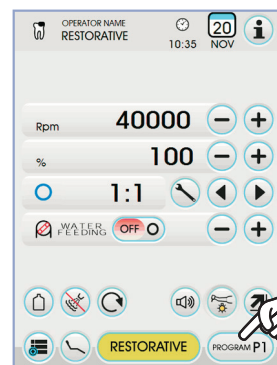
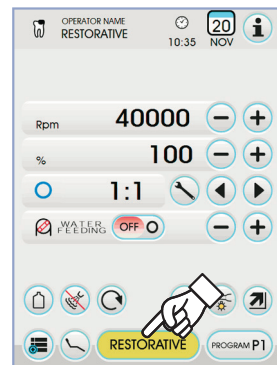
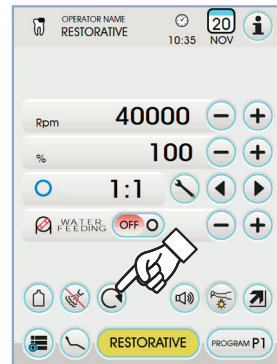
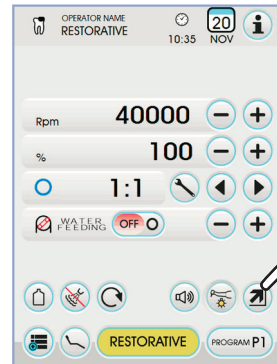
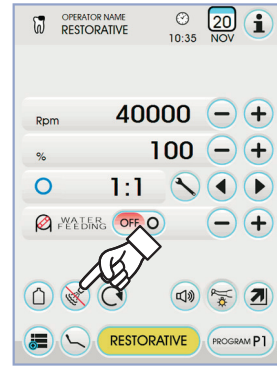



Reduction ratio selection.

Using the icon buttons ◀ or ▶ you can select the desired reduction ratio from those stored.

The torque value (set or current) is expressed in % or Ncm for the certified reduction gears.



WARNING!

An icon appears next to the torque value identifying the reading tolerance on the value indicated:

Ncm	5.0	tolerance of ±10%
Ncm	5.5	tolerance of ±20%



NOTE: the data is automatically stored.

Alarm signal activation/deactivation.

To activate/deactivate the alarm signal when the set maximum torque is reached, touch the relative icon button:



alarm active



alarm inactive



NOTE: the data is automatically stored.

Peristaltic pump activation/deactivation (only if present).

To activate/deactivate the peristaltic pump, touch the relative icon button:



Peristaltic pump inactive



Peristaltic pump active



NOTE: activation is shown in the box next to the value of the physiological saline solution delivered.

Push the icon buttons - or + to modify the quantity of physiological saline solution delivered by the peristaltic pump.



NOTE: the settable value ranges from 1 to 5. The quantity of delivered solution associated with the settable values is the following:

- value 1: approx. 35 cc/min,
- value 2: approx. 50 cc/min,
- value 3: approx. 70 cc/min,
- value 4: approx. 90 cc/min,
- value 5: approx. 100 cc/min.



NOTE: You can change the amount of saline solution delivered by the peristaltic pump also when the instrument is active.

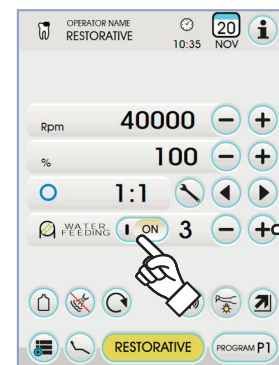
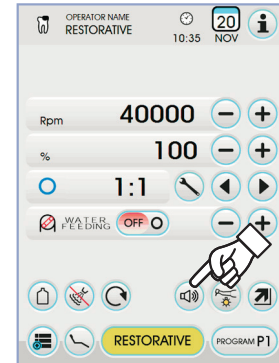
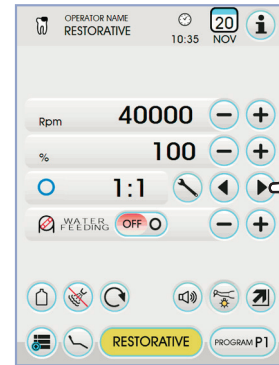

Removable cord

The micromotor has a removable cord to ease cleaning (see paragraph 5.).

Cleaning and care.

Refer to the specific instructions furnished with the instrument.

It is recommended to use Daily Oil (CEFLA s.c.) for lubrication.



WARNING!

- Do not soak the micromotor in liquid disinfectants or detergents.
- Products not recommended: harsh products and/or products containing acetone, chlorine and sodium hypochlorites.

Disinfection.

Handpieces only: steam autoclave up to 135°C following the instructions for use of the device.



WARNING!

Carefully read the operating instructions supplied with the instrument before attempting to sterilize.



Safety guidelines.



- WARNING!**
- Never put the contra angle on the micromotor while it is running.
 - The chuck release button must be held down during operation!
Friction between the button and micromotor rotor overheats the head and may cause burns.
 - The patient's internal tissues (tongue, cheeks, lips, etc...) must be protected against contact with the button by using suitable instruments (mirror, etc...).
 - The chucks and various instruments attached to the handpieces must comply to the standard ISO 10993.

5.5.1. RESTORATIVE operating mode

Characteristics.

- speed adjustable from 100 to 40000 RPM (handpiece 1:1),
- torque adjustable from 1 to 100%
- Customisable list of reduction ratios
- Rotation speed change mode settable from variable to fixed and vice versa
- Alarm signal when the maximum torque is reached
- Fast capture of the maximum speed during motor rotation.

Menu with micromotor extracted but not active.

All the icon buttons are active and each function available can be changed (see paragraph 5.5.).

NOTE: each setting or value changed will automatically be stored in the operating program selected (e.g. P1).

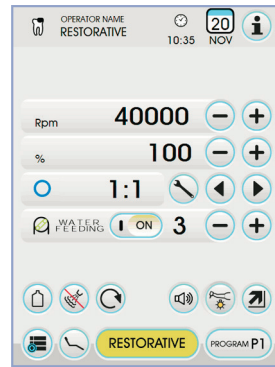

Menu with micromotor extracted and active.

The modifiable functions are the following:

- Maximum drill rotation speed using the icon buttons or .
- Current speed freezing using the following icon button:



Sets the current rotation speed as maximum speed

- Foot control lever change mode using the following icon buttons:



Sets the current rotation speed as maximum speed at the same time activating a function to change the foot control lever ON/OFF mode



Switches the foot control lever change mode from ON/OFF to linear

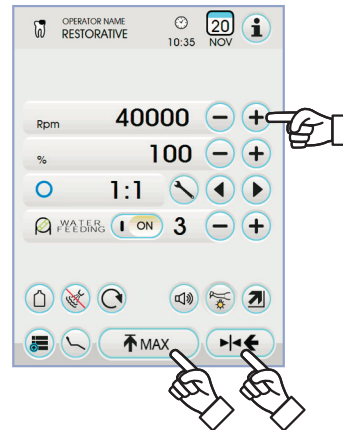

5.5.2. ENDODONTIC operating mode

Characteristics.

- speed value adjustable from 100 to 1200 Rpm with value always referring to the drill, regardless the reduction ratio,
- torque adjustable from 0.1 to 5.0 Ncm, excluding the 1:1 reduction gear (4.5 Ncm),
- customisable list of reduction ratios,
- customisable list for endocanal drill management,
- motor rotation speed change mode settable from variable to fixed and vice versa,
- progressive alarm signal starting from 60% of the maximum torque,
- calibration button during motor rotation.

Menu with micromotor extracted but not active.

All the icon buttons are active and each function available can be changed (see paragraph 5.5.).

As well as the standard settings, in ENDODONTIC mode you can also adjust the following functions:

NOTE: each setting or value changed will automatically be stored in the working program selected (e.g. P1).



• Operation when maximum torque reached.



Rotation lock



Rotation lock and subsequent inversion of the rotation direction



Rotation lock, inversion of the normal rotation direction and subsequent return to the normal rotation direction

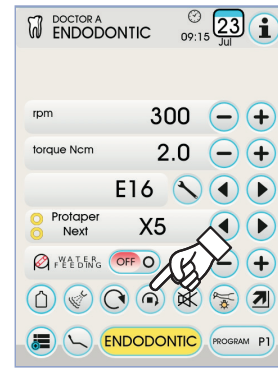

• Customisable list for endocanal drill management.

- Touching the icon button ◀ or ▶ you can scroll the list of preset endocanal drills.

When selecting a new drill, the corresponding speed and torque values will automatically be set.

- Touching the box of the set drill, you access the page with the list of all the available drills.

Here you can scroll through the list and select the desired drill or create customised drills (see paragraph 5.5.2.1.).

Should you change the speed and torque values with respect to those set in the list, the box background turns yellow to alert the dentist that the values recommended by the manufacturer are NOT being used.

If you touch the box of the set drill when it is YELLOW, the optimal values in the list will once again be set and the background changes back to the standard colour.

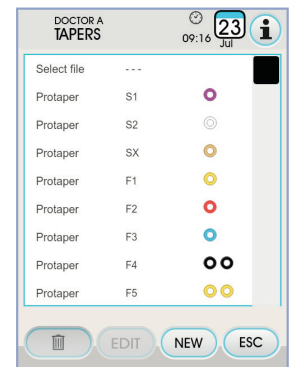
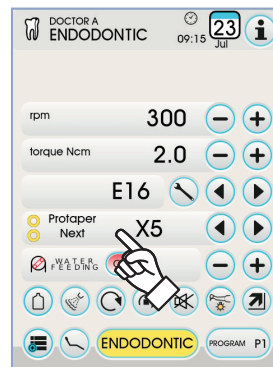

• Preset list of certified counter-angles.

- Touching the icon button ◀ or ▶ you can scroll the list of certified counter-angles.

Display text	Ratio	Torque display	Torque tolerance at the drill	Reference counter-angles
128:1	128:1	100%	⚠ ±20%	All brands
120:1	120:1	100%	⚠ ±20%	All brands
64:1	64:1	100%	⚠ ±20%	All brands
40:1	40:1	100%	⚠ ±20%	All brands
18:1	18:1	100%	⚠ ±20%	All brands
16:1	16:1	5 Ncm	⚠ ±20%	All brands
E16	16:1	5 Ncm	±10%	Castellini E16®
EVO E16	16:1	5 Ncm	±10%	Goldspeed EVO E16®
10:1	10:1	5 Ncm	⚠ ±20%	All brands
ER10	10:1	5 Ncm	±10%	NSK ER10®
9,5:1	9,5:1	5 Ncm	⚠ ±20%	All brands
S6:1	6:1	5 Ncm	±10%	Sirona Endo 6:1
K5,4:1	5,4:1	5 Ncm	±10%	Kavo IntraC 0767 LHC®
4:1	4:1	5 Ncm	⚠ ±20%	All brands
ER4	4:1	5 Ncm	±10%	NSK ER4®
K2,7:1	2,7:1	5 Ncm	±10%	Kavo LUX 7LP® Kavo IntraC 0768 LHC®
WD-79M	2:1	5 Ncm	±10%	W&H WD-79M® W&H EB-79M®
1:1	1:1	4,5 Ncm	±10%	All brands

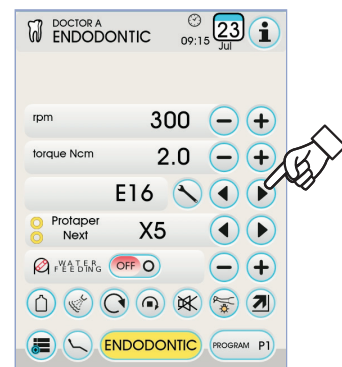

- Touching the icon button, ⚙ you can change the reduction ratio (see paragraph 5.5.4.).



Menu with micromotor extracted and active.

The modifiable functions are the following:

- Maximum drill rotation speed using the icon buttons or .
- Handpiece calibration using the following icon button:

sets the current torque value as 0

NOTE: it is advisable to carry out this operation while letting the handpiece operate at maximum power and with no load.

- Foot control lever change mode using the following icon buttons:

Sets the current rotation speed as maximum speed at the same time activating a function to change the foot control lever ON/OFF mode

Switches the foot control lever change mode from ON/OFF to linear

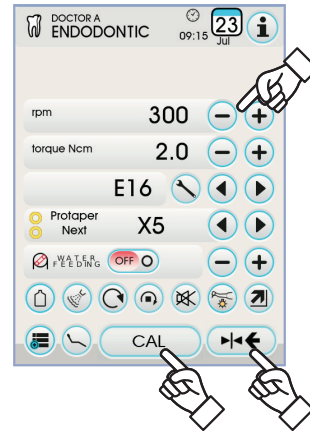

5.5.2.1. Endocanal drill customisation menu

From the menu relating to the extracted but not active micromotor, touching the box of the set drill, you access the page with the list of all the available endocanal drills and the following icon buttons are available:

Deleting a customised drill

Editing a customised drill

Creating a customised drill

Exit from the menu and storage of the data set.

Creating a customised drill.

To create one or more customised endocanal drills, touch the icon button to access the EDITING page:

- touch the icon button to enter the name or code of the customised drill.
- touch the icon button or to increase or decrease the speed or torque value you want to associate with the customised drill,
- touch the icon button or to select the colours of any rings for the customised drill,
- to confirm the data entered, exit the EDITING page by touching the icon button .

Editing and/or deleting a customised drill

NOTE: only the customised drills can be edited and/or deleted.

- Select the customised drill you want to edit or delete.
- touch the icon button to access the EDITING page and edit the drill data.
- touch the icon button to delete the customised drill.



5.5.3. IMPLANT operating mode

Characteristics.

- Speed adjustable from 5 to 2500 rpm with the value always referring to the drill irrespective of the reduction ratio (20:1 to 1000:1 reduction gears)
- Torque adjustable from 0.5 to 55.0 Ncm for the certified reduction gears or from 1 to 100%
- Customisable list of reduction ratios
- Alarm signal when the maximum torque is reached
- calibration button during motor rotation.

Menu with micromotor extracted but not active.

All the icon buttons are active and each function available can be changed (see paragraph 5.5.).

NOTE: each setting or value changed will automatically be stored in the operating program selected (e.g. P1).

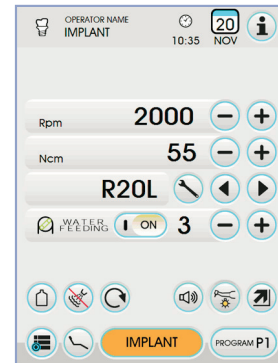

Below is the list of symbols relating to the types of certified counterangle shown on the TOUCH DISPLAY:

Display text	Ratio	Torque display	Torque tolerance at the drill	Reference counter-angles
1000:1	1000:1	50 Ncm	±20%	All brands
256:1	256:1	50 Ncm	±20%	All brands
120:1	120:1	50 Ncm	±20%	All brands
ATR80I	80:1	70 Ncm	±10%	ATR ATR80I®
ER64	64:1	55 Ncm	±10%	NSK SGM-ER64i®
ER32	32:1	55 Ncm	±10%	NSK SGM-ER32i®
K27:1	27:1	55 Ncm	±10%	Kavo IntraLux CL09® + CL3 head®
20:1	20:1	50 Ncm	±20%	All brands
75EKM	20:1	55 Ncm	±10%	W&H WI-75E/KM® W&H WS-75E/KM®
R20L	20:1	55 Ncm	±10%	Castellini R20L® NSK X-SG20L® NSK S-Max SG20® NSK SGM-ER20i®
ATR20I	20:1	70 Ncm	±10%	ATR ATR20I®
WS75	20:1	70 Ncm	±10%	W&H WS-75® W&H WI-75E/KM®
CA20L	20:1	55 Ncm	±10%	Bien-Air CA20:1L®
16:1	16:1			All brands
K12:1	12:1	40 Ncm	±10%	Kavo IntraLux CL04® + CL3 head®

Menu with micromotor extracted and active.

The modifiable functions are the following:

- Maximum drill rotation speed using the icon buttons or .
- Handpiece calibration using the following icon button:



Sets the current torque value as 0

NOTE: it is advisable to carry out this operation while letting the handpiece operate at maximum power and with no load.

- Foot control lever change mode using the following icon buttons:



Sets the current rotation speed as maximum speed at the same time activating a function to change the foot control lever ON/OFF mode



Switches the foot control lever change mode from ON/OFF to linear

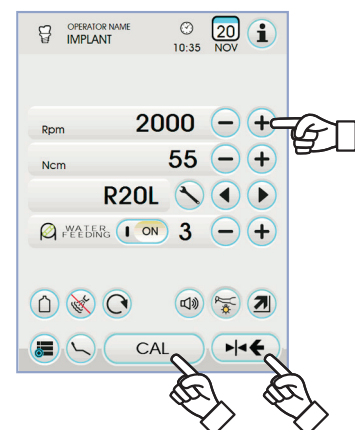



5.5.4. Reduction ratio setting menu

From the menu relating to the micromotor extracted but not active, touch the icon button to access the REDUCTION RATIO SETTING SUBMENU containing the following icon buttons:

- Selection of the reduction ratios stored
- Exit from the menu with storage of the ratio selected
- Creation of a customised reduction ratio
- Modification of a customised reduction ratio

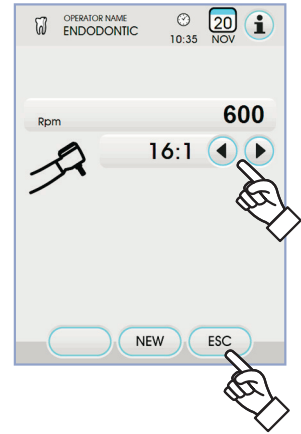
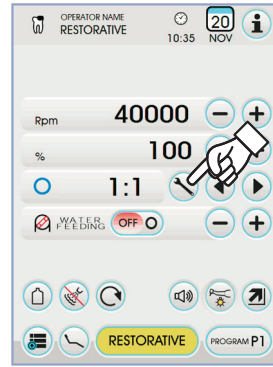

NOTE: the RPM icon is not a modifiable field, as it only displays the maximum speed reachable with the reduction ratio selected.

How to create customised reduction ratios.

To create and store customised reduction ratios, touch the icon button to access the relative submenu containing the following icon buttons:

- Tenths or units increase/decrease
- Created/modified ratio storage
- Default reduction ratio recall
- Customised reduction ratio deletion

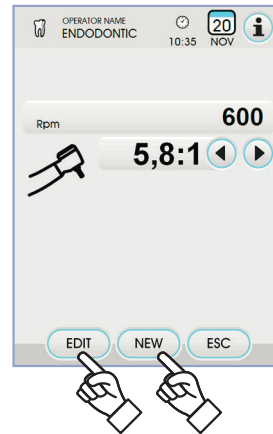

How to modify and/or delete customised reduction ratios.

NOTE: only customised reduction ratios can be modified and/or deleted.

- Touch the icon buttons or to scroll the reduction ratios stored.
- Once you have selected the reduction ratio, touch the icon button to access the EDIT submenu.
- The EDIT submenu is identical to the CREATE submenu.



5.5.5. RECIPROCATING operating mode

Characteristics.

- 2 selectable reduction ratios: 4:1 and 6:1,
- 3 selectable root canal drills,
- progressive alarm signal starting from 60% of maximum set torque.

Menu with micromotor extracted but not active.

All icon buttons are active and all available functions can be edited (see paragraph 5.5.).

In addition to the standard settings, the RECIPROCATING mode also allows adjusting the following functions:

• **Reversing micromotor drill rotation direction.**

Select micromotor drill rotation direction by touching the relevant icon button:



Standard rotation direction: Rotation with reciprocating motion.



Reversed rotation direction: counter clockwise rotation with continuous movement (helps releasing the drill from the root canal). Reversed rotation direction is signalled by a sound (3 BEEPS).



WARNING!

As soon as the micromotor is extracted, a sound (3 BEEPS) warns the operator if the direction of rotation is reversed.

• **Operation at maximum set torque.**



rotation lock



rotation lock followed by rotation direction reversal

• **List of root canal drills.**

Press icon buttons ◀ or ▶ to scroll the list of pre-set root canal drills:

- Waveone® Gold ^[1],
- Reciproc® ^[2],
- Reciproc® Blue ^[2].

^[1] WAVE ONE® is a registered trademark of DENTSPLY SIRONA INC., York, Pennsylvania, USA.

^[2] RECIPROC® is a registered trademark of VDW GmbH, München, Germany.

• **Certified contra angle pre-set list.**

Press icon buttons ◀ or ▶ to scroll the list of the certified contra angles:

Display text	Ratio	Reference contra angles
EVO E4	4:1	Goldspeed EVO E4®
S6:1	6:1	Sirona Endo 6:1

Menu with micromotor extracted and active.

The only active icon button is the activation/deactivation of the alarm signal upon reaching the maximum set torque.

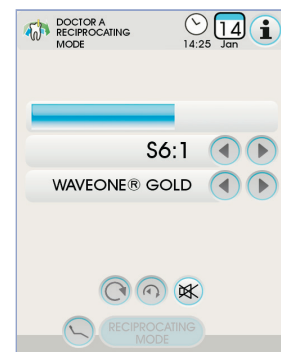
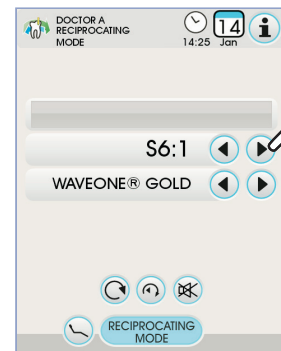
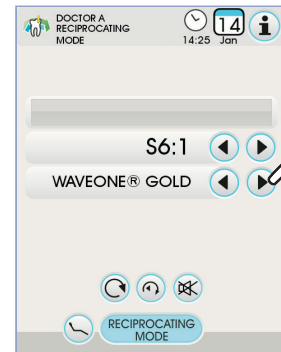
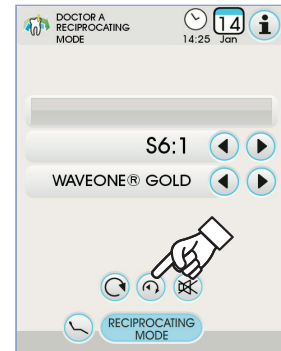
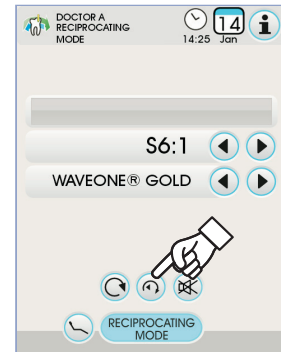



5.6. Scaler

Connecting the handpiece and inserts.

Refer to the specific instructions furnished with the handpiece.



WARNING!

Before attempting to connect the handpiece, make certain the contacts are perfectly dry. Blow air from the syringe, if necessary, to dry.

Safety guidelines



WARNING!

- Make sure the threaded sections of the inserts and handpiece are perfectly clean.
- Do not change the shape of the inserts.
- Check wear and tear of the inserts on a regular basis, replacing them in the following cases:
 - obvious wear.
 - drop in performance.
 - out of shape or banded.
- Notes on PIEZOLIGHT 6 scalers:
 - Class 1 LED apparatus;
 - Do not direct the light beam in anyone's eyes When cleaning or servicing the device (it is recommended to keep the fiber optics shut off).

Use.

- **Operating time:** see operating instructions supplied with the handpiece.
- The cock [f] adjusts the cooling water flow.
- Place the instrument in its work position.



NOTE: instrument activation is indicated by the relative management page appearing on the TOUCH DISPLAY.

- The icon buttons available on the TOUCH DISPLAY are the following:



Scaler power increase



Scaler power decrease



Scaler power change mode selection



Fibre optics on/off



Independent water supply selection/deselection
(only with S.S.S. system)



Cooling water enable



Main page controls



Row of general operating icons
(see paragraph 5.1.)

MIN

Quick selection of 1% of the maximum scaler power

MED

Quick selection of 50% of the maximum scaler power

MAX

Quick selection of 100% of the maximum scaler power

NORMAL

Scaler operating mode selection

PROGRAM P1

Scaler operating program selection

- Use the foot control pedal to start the instrument (see paragraph 5.2).



WARNING!

The instrument is supplied non-sterile.

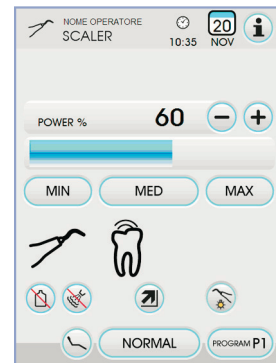
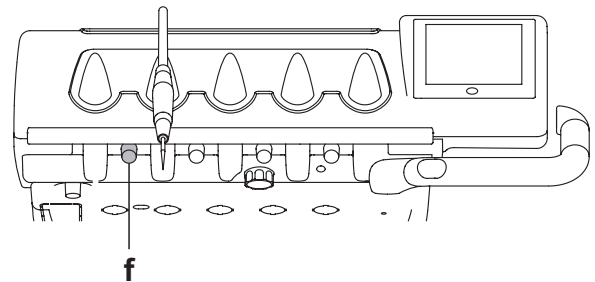



Fibre optic brightness adjustment.

- To adjust the fibre optic brightness, touch and hold (for at least 2 seconds) the icon button
- Adjust the brightness by touching the icon buttons or .
- ☞ **NOTE:** the settable value ranges from 1 to 16.
- To confirm the brightness selected, exit this submenu by touching the icon button .
- ☞ **NOTE:** after 30 seconds of not using the instrument (foot control lever deactivated), the fibre optics turns off.

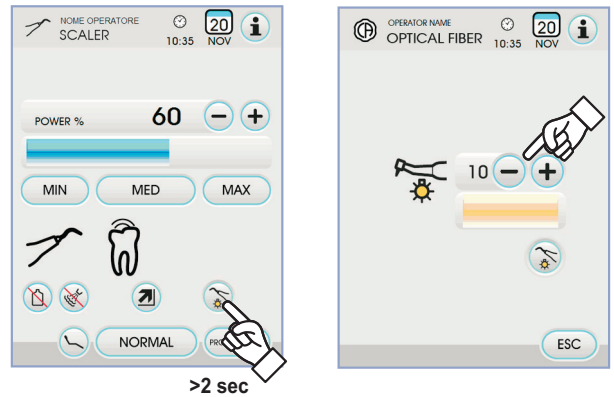

Scaler power change mode selection.

With the instrument in working position, select scaler power change mode by touching the following icon buttons:

- Linear change proportional to the movement of the foot control lever
- ON/OFF change that results in delivery of the maximum power set upon activation of the foot control lever

The active mode icon is shown on the TOUCH DISPLAY.

☞ **NOTE:** the data is automatically stored.

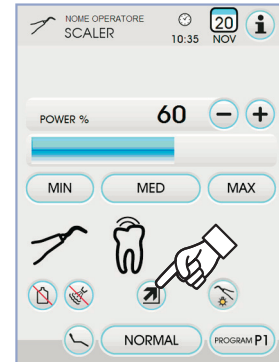

Cooling water enable.

With the instrument in working position, select whether or not water should be delivered by the instrument by touching the following icon buttons:

- Operation with water
- Operation without water

The change is cyclic each time the button is touched and the active mode icon is shown on the TOUCH DISPLAY.

☞ **NOTE:** during operation without water, the maximum power delivered is 50% of the maximum power settable.

☞ **NOTE:** the data is automatically stored.

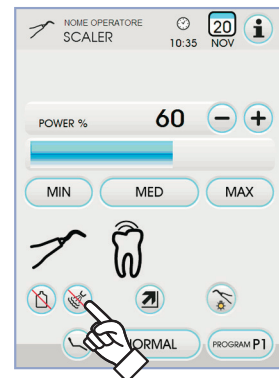

Scaler operating mode selection.

With the instrument in working position, select scaler operating mode by touching the following icon buttons:

- NORMAL** Normal operating mode
- ENDO** ENDO operating mode
- PARO** PARO operating mode (ENDO mode with power reduced by 40%)

The change is cyclic each time the button is touched and the active mode icon is shown on the TOUCH DISPLAY.

☞ **NOTE:** when the foot control is activated, the operating mode cannot be changed.

☞ **NOTE:** the data is automatically stored.

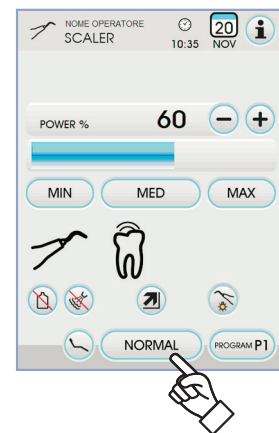



Scaler operating program selection.

The Scaler micromotor has 4 operating programs identified with P1, P2, P3, P4 that can be selected by touching the relative icon button.

Each operating program stores the following data:

- maximum power,
- fibre optics ON/OFF,
- fibre optic brightness
- type of spray delivered
- power change mode.

 **NOTE:** the change occurs cyclically. .

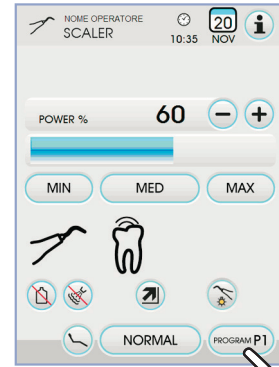

Removable cord

The scaler has a removable cord to ease cleaning (see paragraph 5.).

Cleaning and care.

Refer to the specific instructions furnished with the instrument.



WARNING!

- Do not soak the handpiece in liquid disinfectants or detergents.

Sterilization.

- Torque wrench, scaler bits and scaler handpiece: steam autoclave up to 135°C following the instructions for use of the device.



WARNING!

Carefully read the operating instructions supplied with the instrument before attempting to sterilize.

Safety standards.



WARNING!

- To avoid hazards or malfunctions When connecting the board, do not reverse the positions of the cords for scalers that are different brands.
- The inserts attached to the handpiece must comply to Biocompatibility standard ISO 10993.

5.6.1. SURGISON 2 surgical detartarer device

The SURGISON 2 handpiece is intended exclusively for surgical bone operations in the odontoiatric field. Any other use can cause serious injury to the patient and the damage or breakage of the instrument.

Usage instructions.



CAUTION!

- Ordinary water from the mains must NOT be used for cooling the operational field. Make sure the cooling liquid used is of a suitable sterile type.
- The SURGISON 2 handpiece must only be used with the bits supplied with the instrument or other bits supplied by CASTELLINI S.p.A.
- Do not change the shape of the bit.

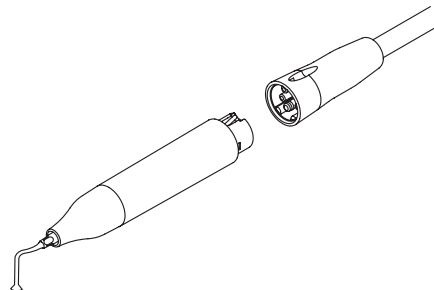



Use.

- **Operating times:** continuous operation.
- Move the instrument into working position; the system automatically detects the presence of the SURGISON 2 handpiece and displays the relative management page.
- The icon buttons available on the TOUCH DISPLAY are the following:

- Scaler power increase
- Scaler power decrease
- Scaler power change mode selection (see paragraph 5.6)
- Row of general operating icons (see paragraph 5.1.)
- MIN** Quick selection of 1% of the maximum scaler power
- MED** Quick selection of 50% of the maximum scaler power
- MAX** Quick selection of 100% of the maximum scaler power
- NORMAL** Operating mode selection for SURGISON 2 scaler
- PROGRAM P1** Working program selection for SURGISON 2 scaler
- ON** Peristaltic pump management (always active)

- To start the instrument, act on the foot control lever (see paragraph 5.2).



WARNING!

The instrument is supplied not sterilized.

SURGISON 2 scaler operating mode selection.

With the instrument in working position, select scaler operating mode by touching the following icon buttons:

- NORMAL** NORMAL operation (see paragraph 5.6.1.1.)
- BOOST** BOOST operation (see paragraph 5.6.1.2.)

The change is cyclic each time the button is touched and the active mode icon is shown on the TOUCH DISPLAY.

NOTE: when the foot control lever is activated, the operating mode cannot be changed.

NOTE: the data is automatically stored.

SURGISON 2 scaler working program selection.

The SURGISON 2 scaler has 4 working programs identified with P1, P2, P3, P4 that can be selected by touching the relative icon button.

- maximum power delivered
- quantity of physiological saline solution delivered by the peristaltic pump,
- modulation set (only for BOOST operation)
- power change mode during operation.

NOTE: the change occurs cyclically.

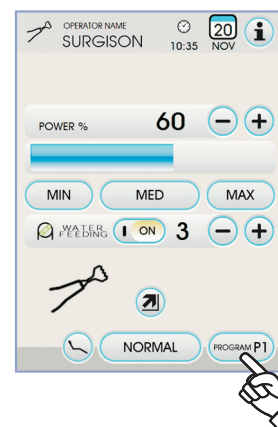
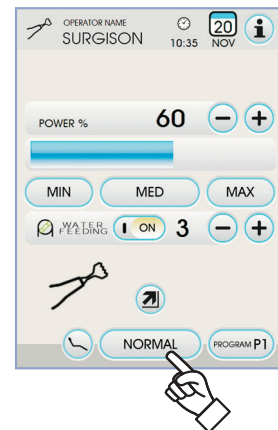
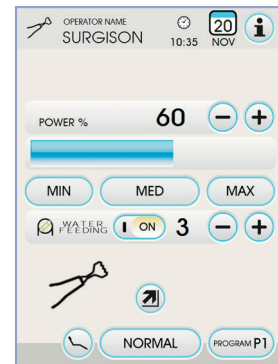



Peristaltic pump management.

With the SURGISON 2 scaler, the peristaltic pump is always active and cannot be deactivated.

- Push the icon buttons **−** or **+** to modify the quantity of physiological saline solution delivered by the peristaltic pump.

NOTE: the settable value ranges from 1 to 5. The quantity of delivered solution associated with the settable values is the following:

- value 1: approx. 35 cc/min,
- value 2: approx. 50 cc/min,
- value 3: approx. 70 cc/min,
- value 4: approx. 90 cc/min,
- value 5: approx. 100 cc/min.

NOTE: You can change the amount of saline solution delivered by the peristaltic pump also when the instrument is active.

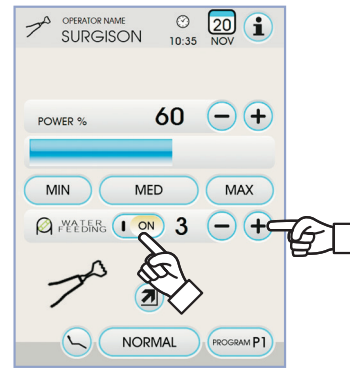

5.6.1.1. NORMAL operational mode

NORMAL operation mode characteristics.

The bit vibrates subject to a continuous power, the amplitude of which depends on the power value set.

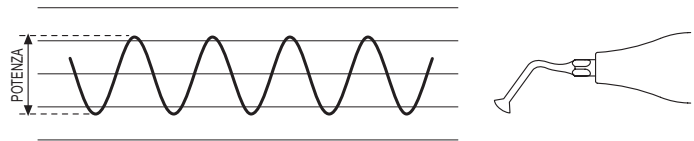
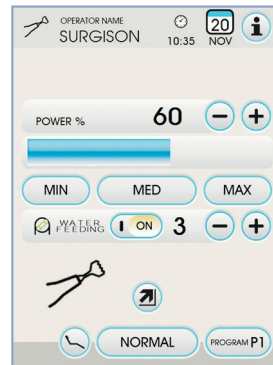

5.6.1.2. BOOST functioning mode

BOOST operation mode characteristics.

In addition to the ultrasonic vibration of the bit, a modulation with the amplitude of the generated power (approx. +40% of the set power) is performed.

The modulation creates a percussion effect on the bone thereby making incision easier.

Three different modulation times can be set depending on the thickness of the bone tissue to be treated.

Modulation type setting (BOONE).

With the instrument in working position, select the type of modulation requested by touching the following icon buttons:

- I** Bone I : hard bone tissue (8ms);
- II** Bone II : medium bone tissue (16ms);
- III** Bone III : soft bone tissue (64ms);

The active modulation icon is shown on the TOUCH DISPLAY.

NOTE: the data is automatically stored.

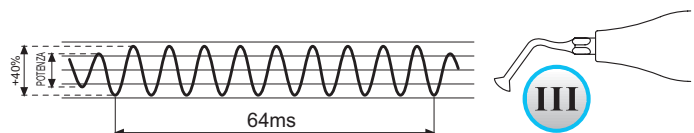
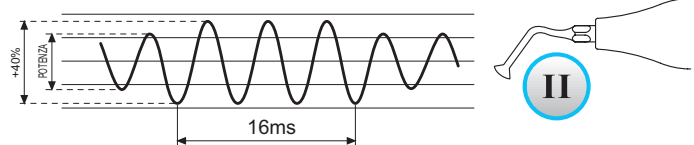
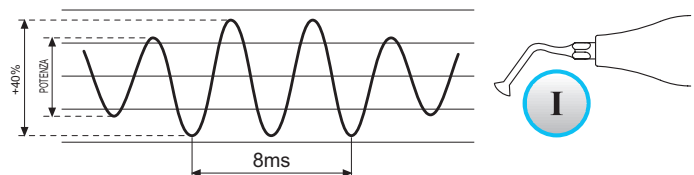
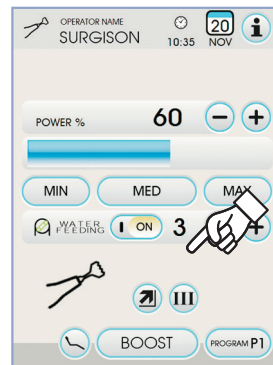



5.7. T LED curing light

Technical specifications.

Supply voltage: 24-36 VDC
 Max. power absorbed: 6 VA
 Light source: 1 5W LED
 Wavelength: 430-490 nm
 Acoustic signals: at cycle start, every 5 seconds, and at cycle end
 Type of operation : intermittent (3 consecutive cycles - 60 sec. rest)
 Programs: 6 (preset)

General description of the light

- a) Light handpiece
- b) Rotary end section
- c) Fiber optic
- d) Eye protection
- e) Power cord
- f) Start button

NOTE: The curing light can be used in different configurations (wand, gun or any intermediate position) to aid the user.

NOTE: The curing light is delivered in its original packing which should be kept for future shipment.

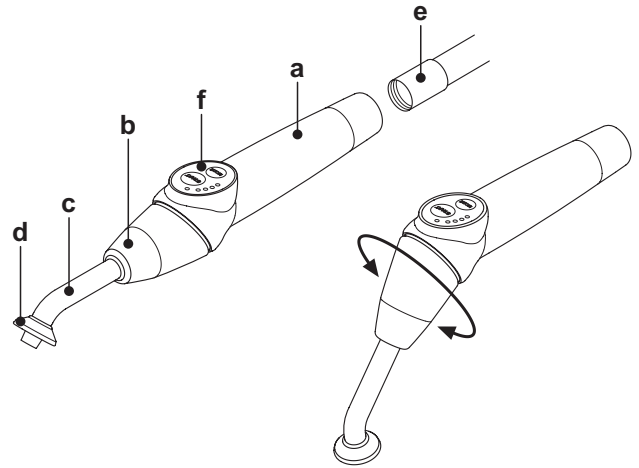

Description of the control pad

- [1] **LED 1 (STANDARD cycle) :**
Emission of 1000 mW/cm² for 20 seconds (this cycle is set as default at the time of sale).
- [2] **LED 2 (FAST cycle) :**
Emission of 1600 mW/cm² for 15 seconds.
- [3] **LED 3 (STRONG cycle) :**
Emission of 1800 mW/cm² for 20 seconds.
- [4] **LED S :**
When LED S is on, you access ramp cycle mode and at the same time the LEDs B, R and L next to it come on:
 [LED S + LED 1] **ramp cycle B (BONDING) :**
Ramp cycle with emission of 500 mW/cm² for 5 seconds, ramp from 500 to 1000 mW/cm² for 5 seconds and 1000 mW/cm² for 5 seconds for a total of 15 seconds.
 [LED S + LED 2] **ramp cycle R (RAPID RESTORATION) :**
Ramp cycle with emission of 500 mW/cm² for 5 seconds, ramp from 500 to 2200 mW/cm² for 5 seconds and 2200 mW/cm² for 5 seconds for a total of 15 seconds.
 [LED S + LED 3] **ramp cycle L (LONG RESTORATION) :**
Ramp cycle with emission of 500 mW/cm² for 5 seconds, ramp from 500 to 1800 mW/cm² for 5 seconds and 1800 mW/cm² for 10 seconds for a total of 20 seconds.
- [5] **Malfunction signalling LED:**
This red LED comes on only if there is a malfunction.
- [6] **START button:**
Pressing the START button starts the cycle selected at that moment (the cycle indication LED will come on).
If it is pressed again at any time during the cycle, light beam emission will immediately be interrupted.
- [7] **MODE button:**
This button is used to select the cycle to be run. It allows changing from the cycle you are in at that moment to the immediately following cycle.
The first three cycles (1, 2 and 3) are at constant power and the LEDs come on individually.
When LED S is on, you access ramp cycle mode and at the same time the LEDs B, R and L next to it come on.
Once the LED of the cycle you intend to use has come on, the lamp is ready for use. Pressing the START button, light beam emission is activated according to the cycle selected .

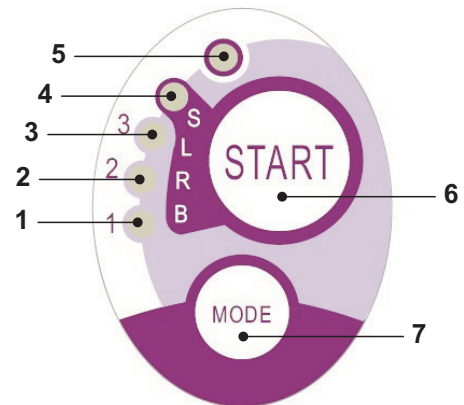

Cycle	LED	Total time	Ø8 mm	Total energy
STANDARD	1	20"	1.000 mW/cm ²	20.000 mJ
FAST	2	15"	1.600 mW/cm ²	24.000 mJ
STRONG	3	20"	1.800 mW/cm ²	36.000 mJ
BONDING	S+1	15"	ramp cycle	11.250 mJ
RAPID REST.	S+2	15"	ramp cycle	20.250 mJ
LONG REST.	S+3	20"	ramp cycle	26.250 mJ

NOTE: the cycle can be selected and the button is operative only when the curing light is not emitting any light. If the button is accidentally pressed while light is being emitted, nothing will happen.

Operation.



WARNING!

The instrument is supplied non-sterile.

Before use, disinfect the lamp grip. The fiber optic and the eye protection can be sterilised in a steam autoclave up to 135°C.

- Put the fiber optic (c) in its housing until it clicks.
- Attach the curing light handpiece to the end of its power cord and tighten the ring (e).

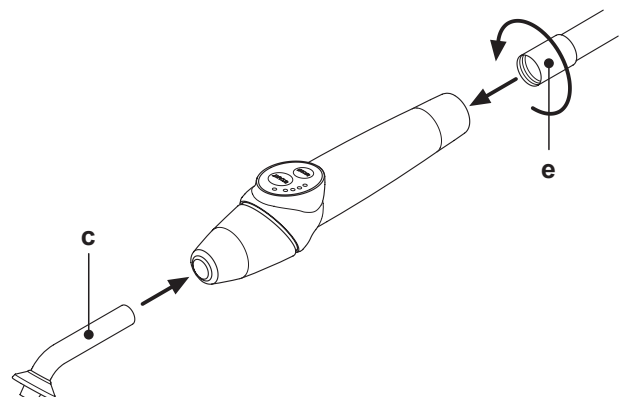



- Take the light out of its housing on the assistant's board or instrument board.

NOTE: instrument activation is indicated by the relative management page appearing on the TOUCH DISPLAY.

- Turn the front of the light and/or fiber optic to the position most suitable for curing (wand, gun or intermediate position).
- Use the MODE button to select the desired cycle as previously directed (the selected cycle is always indicated by the illuminated LED).

NOTE: The curing light has a permanent memory therefore the last cycle used will always be present the next time it is used.

- Place the fiber optic in the position required for curing.

NOTE: The fiber optic should be placed as close to the material to be cured as possible without touching it.

- Press button START to start the cycle.



WARNING!

Operation: runs 2 consecutive cycles, rests 60 seconds.

NOTE: When a programmed cycle is activated, the LEDs (1, 2, 3, B, R, L) indicate the time that elapses (in multiples of 5 seconds) and turn off every 5 seconds of operation.

The curing light comes with a beep that BEEPS when the cycle starts, BEEPS every 5 seconds of operation and lastly BEEPS twice at the end of the work cycle.

- Allow light emission to stop by itself. However, it can be stopped at any time by simply pressing the START button again.



WARNING!

- The curing light is equipped with a system that signals malfunctions by illuminating the LEDs in different combinations (see next paragraph).
- The curing light is equipped with a cut-out.

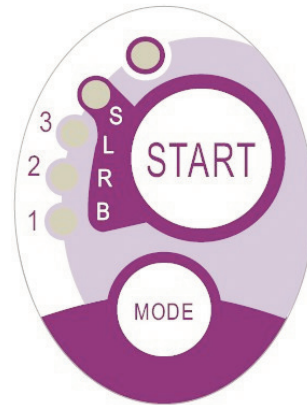
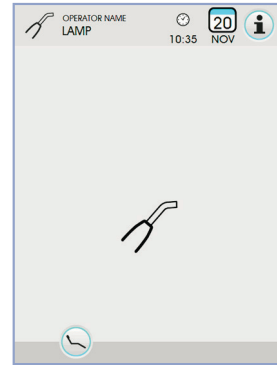

Indicators.

The following indicators are provided on the control console to signal curing light failure:

- **LED 5 and LED 1, green, constantly on.**
Lamp does not emit any light. Contact technical service department.
- **LED 5 and LED 2, green, constantly on.**
Instrument start up controller failure.
Contact technical service department.
- **LED 5 and LED 3, green, constantly on.**
Power supply too low.
Contact technical service department.
- **LED 5 and LED 4 flash continuously.**
Handpiece cut-out tripped. These LEDs will continue to flash until the light has cooled down enough (about 5 minutes) for it to be used again.
If the problems persists, contact the technical service department.

Maximum curable thickness.

The maximum curing thickness with single cycles is 3 millimeters (refer to the instructions of the composite material used as well).



WARNING!

This thickness must not be exceeded as the layer may not be completely cured.

General warnings.

WARNING!

- The LED is a Class 2 light source in accordance with IEC 62471. **DO NOT FIX THE BEAM.**
The light emitted may cause eye damage in the event of direct radiation without eye protection.
Eye protection must always be worn when using the curing lamp and do not direct the light beam in eyes.
The light emitted may damage soft tissues (oral cavity mucous, gums, skin).
Be extremely careful to direct the light precisely on the material to be cured.
- **People with eye diseases, such as those who have had cataracts removed or retina diseases must be adequately protected when the curing lamp is used, for example with suitable protective eyewear.**
- **The rotary end can turn 180° counter-clockwise in relation to the handpiece to change over from wand to gun configuration.**
To go back to wand configuration, turn clockwise.
A click is heard when the two positions are reached. Do not turn any more once the click is heard.
The intermediate positions can be used even if a click is not heard.
Put the fiber optic back into the correct position after turning the end section.
- **Do not pull the power cord.**
- **Do not expose the handpiece to excessive vibrations.**
- **Do not drop the handpiece and in particular the fiber optic. The lamp may break if accidentally banged.**
Check the condition of the handpiece if it has been banged or dropped before using the curing light. Try to turn on the light and check operation first without using it on the patient.
If cracked, broken or if there are any other faults, do not use the curing light on the patient and contact the technical service department.
The fiber optic is rather delicate and may crack or break if banged, affecting the final amount of light emitted.



If dropped, carefully inspect the fiber optic to verify if it is cracked or broken. If cracked, a strong light appears in the spot in which the fiber is cracked. In all these cases, the fiber optic must be replaced.

- **The curing light handpiece (sold separately) can be connected only to dental units with connections for this curing lamp. Connection to any other equipment may damage the circuits inside the lamp and seriously injure the user and patient.**
- **The curing lamp handpiece is not protected against liquid penetration (IP20).**
- **The curing lamp handpiece is not suitable for use in the presence of flammable anaesthetic gas mixed with air, oxygen or nitrous oxide (N₂O).**

Cleaning.

The curing lamp may be a vehicle for cross contamination between patients. The most contaminated parts are the fiber optic and eye protection. Before sterilizing them, make sure there are no residues of curing products: if necessary, clean with alcohol or a plastic spatula. Exclusively sterilize the optical fibre and the eye protection in an autoclave at a sterilization temperature of at least 134°C.



WARNING!

- **The fiber optic is able to support 500 autoclave cycles after which it tends to become opaque and therefore emit less light.**
- **The eye protection must also be replaced after 500 cycles.**
- **Contact the manufacturer to purchase original spare parts (fiber optic + eye protection: code 97660404).**

The handpiece cannot be put in autoclave; disinfect it on the outside with suitable products and cover it with disposable plastic wrap. Use soft disposable paper towels to disinfect the handpiece. Do not use harsh products or soak in liquids.



WARNING!

- **The curing light handpiece is NOT suitable for autoclave.**
- **The curing light handpiece is not protected against penetration of liquids therefore it CANNOT be soaked in solution to be sterilized.**
- **The outside of the lamp should be disinfected with the fiber optic on. Do not use any type of disinfectant on the exposed optical surface of the handpiece when the fiber is removed. The surface will become irreparably opaque if it comes into contact with disinfectant.**

Maintenance.

This equipment does not require any particular type of maintenance. Only technicians authorized by the manufacturer can replace and/or repair the handpiece and dental unit. The handpiece has been purposely constructed in a manner that requires specific tools to open it and therefore it cannot be removed by the user. The warranty is automatically void if the handpiece is altered in any way.

Troubleshooting.

- **When the lamp is removed, the light does not come on (no leds on control console illuminated).**

Make sure the Midwest connection is correctly attached to the power cord.

Carefully screw the ring, try to turn on the lamp and then take it off again.

If the problem persists, contact the technical service department.

- **Less light emitted**

- Make certain the fiber optic is not cracked or damaged in any way: replace it if it is.

Contact the manufacturer to purchase original spare parts.

- Make sure there are no residues of curing products on the end of the fiber optic: if necessary, wipe off with alcohol or a plastic spatula.

If the handpiece has to be sent back, please disinfect it.

Ship it back in its original packing.

In addition, please enclose a description of the fault with the shipping note.

5.8. C-U2 and C-U2 PRO intraoral camera system

The C-U2 dental camera system, complete with an extremely lightweight ergonomic handpiece, is specially designed for simple and well-conceived usability in examining the oral cavity. Auto-exposure and fixed focus features provide easy operation. This system is designed to allow the dentist to more efficiently show and explain to patients all oral conditions and reasons for planned treatment. The C-U2 system allows taking high-definition (1280x720) live images of the section in question through the touch of a fingertip on the touch-sensitive area of the handpiece. The live intraoral images are displayed on the monitor or Personal Computer.

! WARNING!

The camera may be used as a tool to aid in diagnosis; however, the result must always be supported with visual examination and/or other diagnostic indications. Evaluations and conclusions based only on the image taken by the camera may be poor as the colours and shapes, electronically processed, may not perfectly correspond to the actual ones.

Warnings for use.

! WARNING!

- The external PC and the external monitor must be of medical grade, namely they have to be certified and comply with the IEC 60601-1 Standard 3 rd Ed. They have to be able to ensure a double insulation level for both patient (2 MOPP) and operator (2 MOOP): - with respect to the power mains; - to all the I/O ports (USB, LAN) supplied with Safety Extra Low Voltage (SELV).
- Even though the electromagnetic field irradiated by the device is insignificant, it is advisable not to use it in proximity of life support equipment (e.g. pacemakers or heart stimulators) according to the specifications included in the user manual of such equipment.
- The disposable infection control sheaths must be used with the device. Change the sheath for each new patient.
- After putting on a new disposable infection control sheath, check it over before using the camera, making sure it is not torn anywhere. If it is, take it off and put on a new one.
- Do not place the handpiece in liquids or in autoclave under any circumstances.
- Store the handpiece in a clean dry area.
- Do not bend the connecting cable excessively.
- Be extremely careful not to drop the handpiece and do not expose it to excessive vibrations.
- Never use a damaged handpiece. Make sure the camera is in good condition and has no sharp edges before attempting to use it. If in doubt, do not use the handpiece, carefully put it away, and contact technical assistance.
- Before starting the equipment, check the condition of the lens protection.
- Do not aim the light beam at the operator's or patient's eyes during operation.
- During continuous use (example, more than 10 consecutive minutes), the temperature of the camera's tip usually increases significantly; if this is uncomfortable, put the handpiece in its holder for a few minutes to allow the light source to cool down. When the camera needs to be used for a prolonged time, reduce light brightness using the cursor on the OSD Control Panel (see paragraph 5.8.1.).
- If left running for extended periods, make sure the temperature of the tip is acceptable before attempting to use the camera. Briefly touch the clear plastic part with your fingertip being careful not to touch the lens in the middle.
- Do not attempt to bend, pull or remove the handpiece.

Connecting the handpiece.

Attach the handpiece of camera C-U2 (**a**) to the end of the cord and tighten the ring nut (**b**).

! WARNING!

Make sure the cord is firmly screwed onto the handpiece.

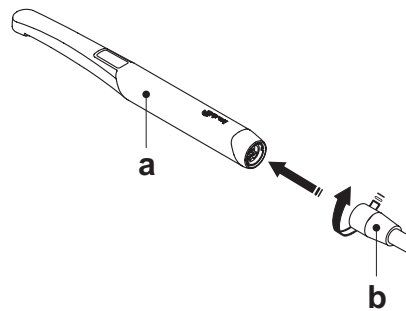

Use of the camera.

- Place the instrument in its working position. Now camera is activated and is in LIVE mode (monitor shows "moving" images) or FREEZE mode (monitor shows a snapshot).
- The main icon buttons available on the TOUCH DISPLAY are:

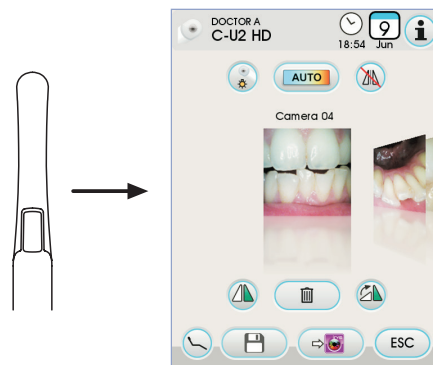
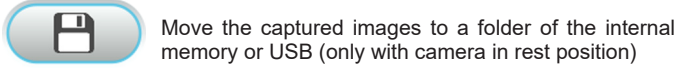
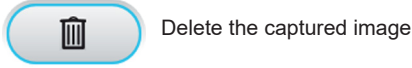
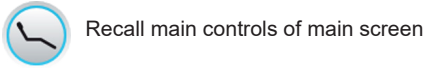
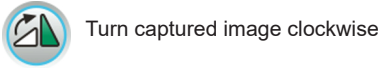
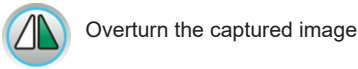
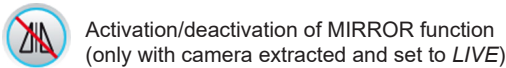
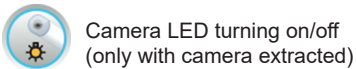
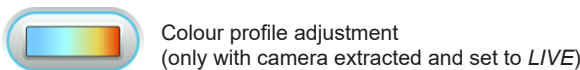



Move the captured images to an iRYS folder (only with camera in rest position and PC connected to IRYS)



Move the captured images to the PC (only with camera in rest position and PC connected to iCapture).



Go back to the main screen without moving the captured images.

- Shortly press the touch key on camera handpiece or operate the foot control to capture the image shown on the monitor.
To go back to "live" image, simply touch again the touch key on camera handpiece or operate again the foot control.
- When camera is put back in place, the screen with captured images is still shown on the TOUCH DISPLAY; to go back to main screen, simply touch icon button .

Camera LED brightness adjustment.

- To adjust camera LED brightness, touch icon button (for at least 2 seconds).
Adjust brightness level by touching icon buttons or or scrolling the bargraph with your finger.

NOTE: value setting range: 1 to 16.

- To confirm the selected brightness, simply quit this sub-menu by touching icon button .

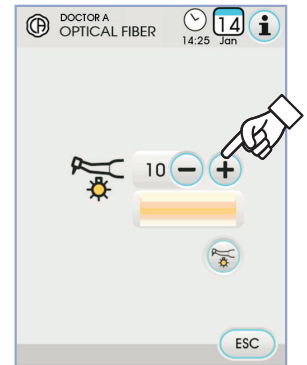

Colour profile adjustment.

Touch icon button to gradually shift from a "colder" colour profile to a "warmer" one.
"AUTO" status activates the automatic white balance function, which can be used under particular conditions when the previous profiles are not satisfactory.

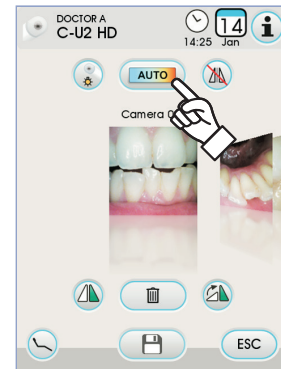

MIRROR function.

Touch icon button to shift from real to mirror image displaying mode.
The icon corresponding to the active mode is shown on the TOUCH DISPLAY:



Real image.



Mirror image

NOTE: this function is available in LIVE mode, only.

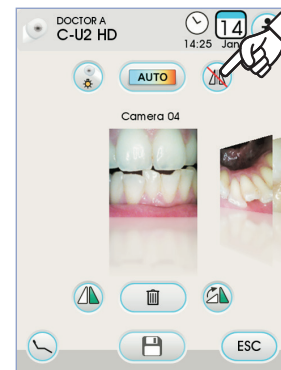

FREEZE function.

This camera can freeze images on the monitor.
This function can be enabled in 2 ways: by pressing touch key (g) on camera handpiece or by operating the foot control (see paragraph 5.2.).
Each captured image is automatically stored inside console inner memory.

NOTE: at the end of each treatment, we recommend transferring all the captured images inside a special folder associated to the patient.

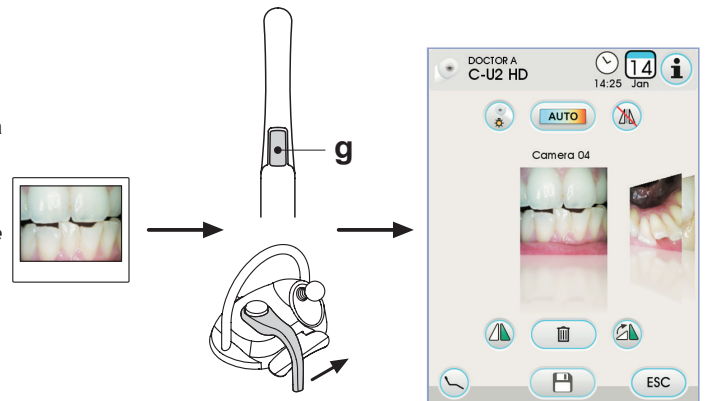









Captured image displaying.

To display a captured image in full-screen mode, proceed as follows:

- Scroll the saved images by touching the side thumbnails.
- Touch the central image to display it in full-screen mode.
- Now the following icon buttons are available on the TOUCH DISPLAY:

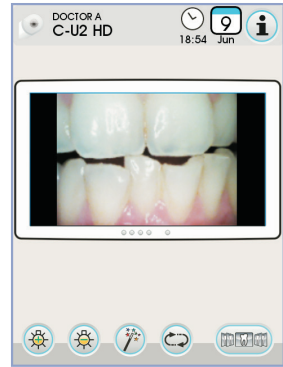
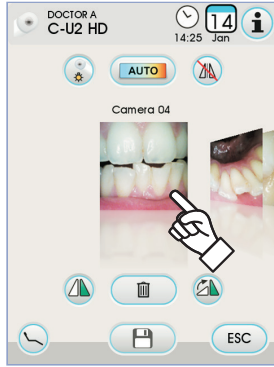
-  Image automatic improvement
-  Increase image brightness
-  Reduce image brightness
-  Restore image original appearance
-  Go back to "thumbnail" screen









 **NOTE:** changes made to the image are automatically saved.

Moving the captured images to an internal memory or a USB key.

Each captured image is automatically stored inside console inner memory. To transfer all captured images inside a specific working folder, proceed as follows:

- Put camera handpiece back in place.
- Touch icon button  to access the navigation screen.
- Now the following icon buttons are available on the TOUCH DISPLAY:

-  Display other available options.
-  Go back to "thumbnail" screen.
-  Confirm image transfer to the selected folder.
-  Create a new folder.

- Touch the folder you want to select or create a new folder by touching icon button  .
- Give a name to the new folder and confirm by touching icon button  .
- Now simply touch icon button  to transfer all the images present inside console inner memory to the selected folder

 **NOTE:** images are transferred all together, this is why we recommend carrying out this operation after seeing each patient

The image folders saved on console internal memory can be copied at any time on a USB flash drive (see paragraph 5.1.1.2.16.).

 **NOTE:** console internal memory can store up to approx. 20,000 images taken by the camera. Once the available space is running out, a warning message will appear on the TOUCH DISPLAY.

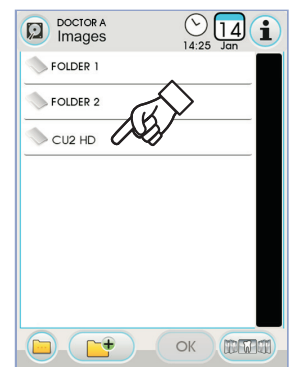
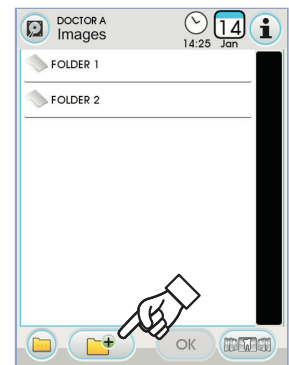
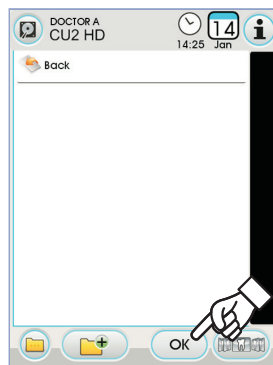
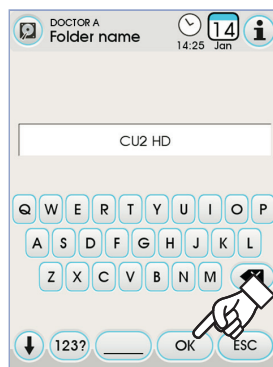
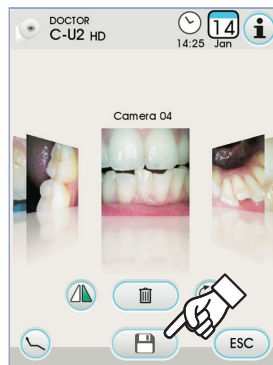



Moving the captured images to iRYS.

To move all captured images to a specific iRYS patient folder, proceed as follows:

- Put camera handpiece back in place.
- Touch icon button to access the navigation screen .
- Select the desired patient folder by means of the various search functions (see paragraph 5.1.1.2.17.1.).
- Now simply touch icon button to move all the images present inside console internal memory to the selected folder.

NOTE: images are moved all together, this is why we recommend carrying out this operation after seeing each patient.

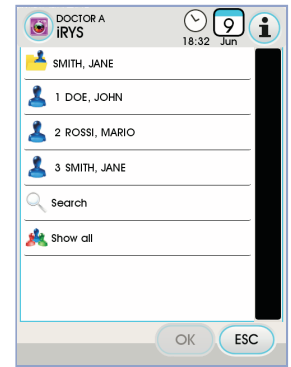
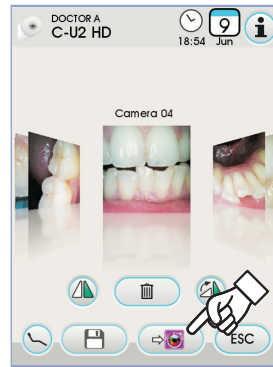

Moving the captured images to a PC with image management software.

To move all captured images to a PC equipped with a generic image management software, proceed as follows:

- Put camera handpiece back in place.
- Touch icon button to move all the images present inside console internal memory to a pre-set PC folder.

NOTE: the PC storage folder is set by means of the iCapture programme (see user's manual supplied with the programme).

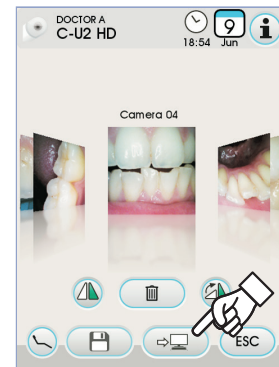

Handpiece status

An optical guide, illuminated by a multicolour LED indicator, found in the area near the control button (**g**), shows handpiece status as per the table given below:

Colour	Situation
Blue light flashes, very slowly	Handpiece in standby
Light blue steady light	Handpiece activated, live images displayed
Blue/ light blue flashing light	Handpiece in image freeze mode
Brief red flashes	Internal error: contact Technical Service

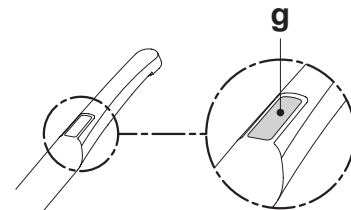

MyRay iCapture.

This programme allows the C-U2 camera to be set up when it is connected to a PC/WORKSTATION.

For a full description on how the MyRay iCapture programme works, refer to the instructions, in electronic format, supplied with the C-U2 handpiece.





Disposable infection control sheaths.

The camera can be a source of cross-contamination between patients. For this reason always use it with a disposable infection control sheath (code 97901590) and disinfect it on the outside after use everyday.

The sheath (with white paper backing) is enclosed in two protective layers: a transparent one with blue tab at the front and a paper one at the back. Follow the directions below to install a new infection control sheath:

- 1 Insert the camera handpiece tip between the layer with White tab and the rear paper backing. The lens, surrounded by the LEDS, must face down, towards the rear paper layer. Gently push the handpiece to the end of the sheath.
- 2 Pull the blue tab removing the protective films.
- 3 The camera is now protected and ready for use.

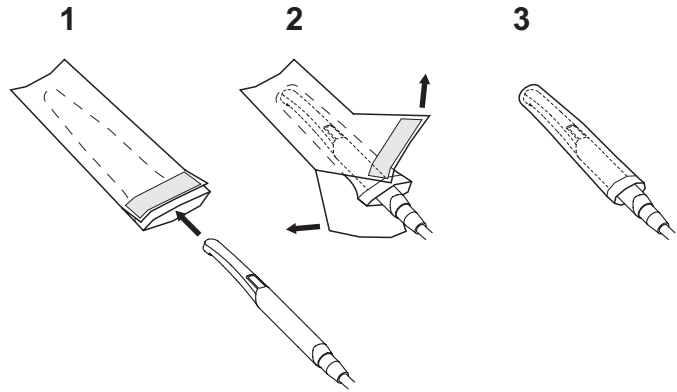

WARNING:

- Always make certain the handpiece is correctly inserted inside the infection control sheath.
- To ensure user and patient safety, always change the disposable infection control sheath before using the device on a new patient.
- Disposal: the disposable infection control sheaths are to be treated as special waste materials (like surgical gloves).

Cleaning and disinfection.

Clean the handpiece with a suitable product after each use: refer to paragraph 1.4.

WARNING:

- The dental camera is not designed for cold sterilization by being soaked, for example, in solutions such as glutaraldehyde or hydrogen peroxide (oxygenated water).
- All products must be used as directed by the manufacturer.
- All materials used to clean and disinfect must be thrown away.

Maintenance and repairs.

The C-U2 dental camera does not require any particular maintenance. In the event of malfunctions, please send back the complete handpiece.

WARNING:

There are no parts that can be repaired on site. In the event of a malfunction, please contact an authorized dealer.

Returning parts.

- Please send back any defective devices in their original packaging. Do not reuse damaged boxes.
- The device must be disinfected before being shipped to prevent cross-contamination. Handpieces that have not been adequately cleaned and disinfected will not be accepted.

WARNING:

The sender shall be held responsible for any equipment damage occurred during shipment regardless of whether or not the devices are under warranty.



5.9. Peristaltic pump

This device allows saline solution to be supplied through a single-use administration line without any contact.
Devices available only with the micromotor.



NOTE:

- In order to use with the micromotor, contrangles with external cooling or for hollow burs are required (Goldspeed R20-L type).
- In order to use with the scaler, handpiece SURGISON 2 is required.

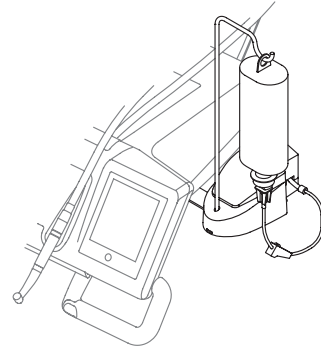

Description of the symbols present on the device.

- 1) Material meets and exceeds the essential requirements of directive EEC 93/42 and subsequent changes.
- 2) CAUTION: PINCH HAZARD.
Do not put your fingers in rotating parts.
- 3) Material sterilized with ethylene oxide
- 4) Expiration date (yyyy-mm).
- 5) Single-use material.
- 6) Material identification code



Putting into service

- Direct and put the IV drip pole [a] in place and hang the flask or bottle [b] that contains the saline solution.
- Open the bag [c] and take out the sterile administration line.



WARNING!

Use sterile disposable gloves.



WARNING!

Check the condition of the packaging as well as the expiration date of the administration line. Only CEFLA s.c. administration kits guarantee proper trouble-free operation. These lines are sterile and disposable, reusing them may put patients at risk of microbiological contamination.

- Open the cover [d] of the peristaltic pump, turning it upwards.
- Attach the tube, being careful to place the part with the largest diameter inside the pump's V seats. The pump rotates clockwise. Place the tube so that the section that runs from the bag enters from the left side of the pump (see figure).
- Close the cover [d]. If it does not close, open the cover again and check the position of the tube.



WARNING!

Do not start the pump with the cover [d] open, finger pinch hazard.

- Pierce the cap [b] of the bottle of saline solution with the outflow tip of the administration line [c].
- Attach the administration line to the instrument cord using the plastic clips provided in the sterile kit.



NOTE: use type A for the scaler's cord and type B for the micromotor's cord.

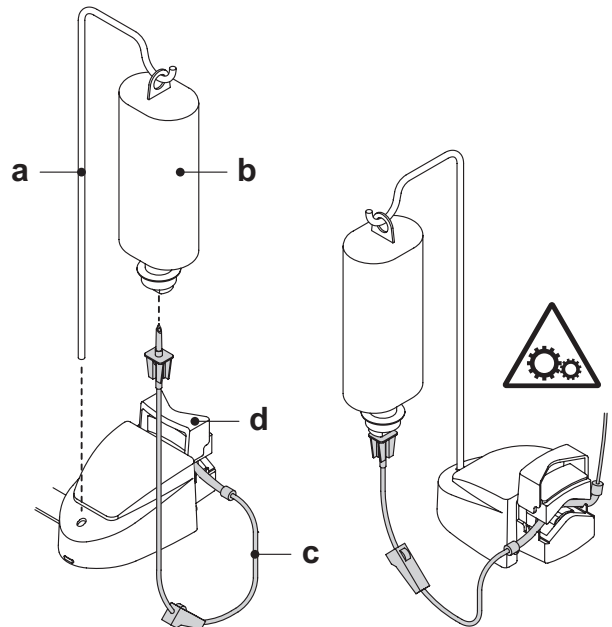

Operation.

To activate/deactivate peristaltic pump operation, remove the handpiece and touch the relative icon button:



Peristaltic pump inactive



Peristaltic pump active



NOTE: Activation is confirmed by shown in the box next to the value of the physiological saline solution delivered.

If necessary, touch the icon buttons or to change the amount of saline solution delivered by the peristaltic pump.



NOTE: the settable value ranges from 1 to 5. The quantity of delivered solution associated with the settable values is the following:

- value 1: approx. 35 cc/min,
- value 2: approx. 50 cc/min,
- value 3: approx. 70 cc/min,
- value 4: approx. 90 cc/min,
- value 5: approx. 100 cc/min.



NOTE: You can change the amount of saline solution delivered by the peristaltic pump also when the instrument is active.

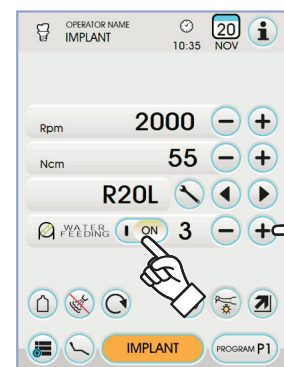



5.10. Electronic apex locator (LAEC)

By analyzing resistance to a small electric current, LAEC is able to help in locating the root apex. If used together with a "file" (not provided) for manual treatment, it is an important tool in measuring the length of the canal itself. Besides using the apex locator in manual mode on this dental unit, this device can also be used with micromotor "ENDO" mode. The position of the instruments used on the handpieces can be monitored as the LAEC signals directly reach the files, through the instrument cords, thereby allowing the position of the canal to be monitored during treatment.

Description of the components.

- [1] LAEC outer cable.
- [1.1] LAEC outer cable - neutral pole.
- [1.2] LAEC outer cable - active pole.
- [2] Hook electrode.
- [3] Probe.
- [4] LAEC clip connecting forceps.
- [5] Outlet for LAEC outer cable .

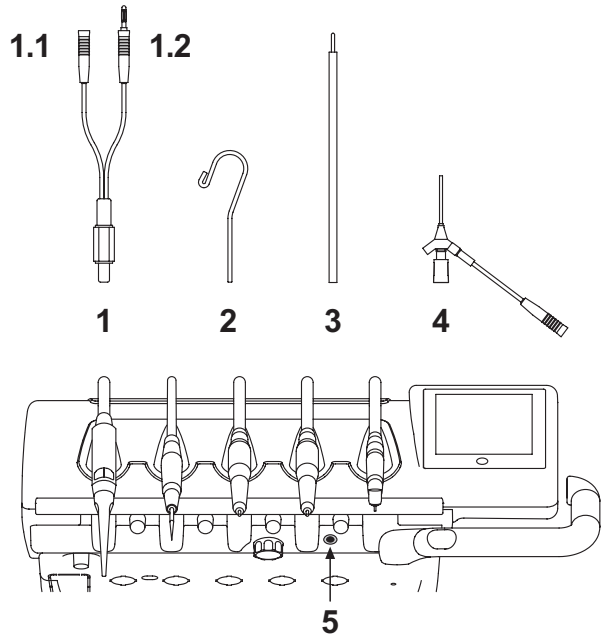

Operation.

- In this dental unit, the LAEC automatically turns on when the outer cable [1] is inserted in the outlet [5] placed under the instrument board. When turned on, the menu for setting the alarm threshold appears on the display (see paragraph 5.1.1.2.11.).
- Applying the electrodes:
 - Connect the hook electrode [2] to the neutral pole [1.1] and place it on the patient's lip.
 - Connect the active pole [1.2] to the file (not provided) placed on the root canal; connection to the file can be done using the probe [3], forceps [4] or with the fittings provided for the handpieces.



WARNING!
The electrodes are not sterile when supplied.

Indications given on the display.

- The bar graph on the left side of the display shows the position of the file in relation to the apex. Numbers "1, 2, 3" represent the distance between the instrument and apex.
- Icon APEX shows the distance of the instrument from the apex.
 - NOTE:** indication " > 4 " means that the file is too far away from the apex in order for it to be measured.
- Icon ALARM shows the set alarm threshold. The alarm threshold identifies the distance between the instrument and apex, beyond which a beep is emitted that gradually increases as it gets closer to the apex. See paragraph 5.1.1.2.11 for instructions on how to set the alarm threshold.

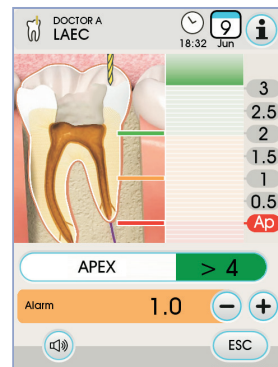

The graphic and numeric readings are constantly updated while the file is being introduced in the canal.

LAEC combined with the electric micromotor.

The LAEC can also be used in combination with the electric micromotor when set to ENDO mode or to RECIPROCATING mode. When the LAEC is turned on, information about the micromotor and the LAEC (bar graph and APEX value) is displayed when the electric micromotor is withdrawn in ENDO mode. While the electric micromotor is running, the keys are associated to the instrument's functions and therefore it is not possible to modify the alarm threshold of the LAEC if the instrument is not put back in place. With the S6:1 and EVO E4 contra angles it is also possible to enable the APEX STOP function, which automatically stops the micromotor once the alarm threshold is reached.

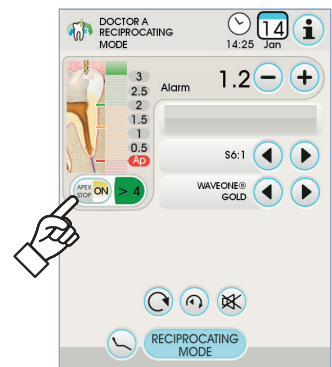
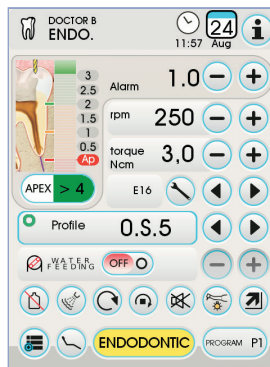

APEX STOP disabled



APEX STOP enabled



Measuring the length of the root canal.

- Use of the manual file is fundamental to measure the canal. The correct procedure consists of placing the file into the canal and advancing until 0.5 is reached.
- Move the file further forward slowly turning clockwise until APEX appears on the instrument.
- Once APEX appears, back up the file turning it counter-clockwise until 0.5 is obtained again. Place the rubber stop at the occlusal surface as the reference point for determining the length of the root canal.
- Take an x-ray to verify the file is in the correct position.
- Remove the file from the canal and measure the length with a ruler. Subtract 0.5-1 mm from the measured value.



WARNING!

Always use the LAEC together with an x-ray to precisely determine the position of the apex.

Various morphological situations which are not always foreseeable may result in readings that are not always precise.

For example:

- excessively wide root canal;
- shrinkage;
- broken roots;
- presence of metal crowns.

5.11. ZEN-XI INTEGRATED SENSOR

The ZEN-Xi integrated sensor is a medical device used for the acquisition of intraoral X-rays in electronic format through the interface with the FULL TOUCH console or a Personal Computer.

WARNING:

Do not use the system for tasks other than the acquisition of intraoral X-rays, and do not use it if you are not an expert in dentistry and radiology.

Use.

WARNING:

ZEN-Xi integrated sensor instructions for use are included with the equipment, please read carefully the warnings for use before turning sensor on.

Hereinafter is a list of the possible interactions with the FULL TOUCH console only:

- Turn ZEN-Xi sensor on (see instructions for use).
- If sensor is connected, after a few seconds the icon on the top left side of TOUCH DISPLAY will turn green and the ZEN-Xi sensor will be ready to receive an X-ray.
- Position the X-ray sensor inside patient oral cavity, then start the X-ray exposure (see instructions for use).

WARNING:

Before carrying out the X-ray exposure, make sure that the ZEN-Xi warning light is green.

After a few moments, the image will appear on the DISPLAY and on the screen of the connected monitor.

WARNING:

Do not take x-ray pictures on a patient when testing the system for the first time or verifying correct operation. Use phantoms to conduct tests.

- The main icon buttons available on the TOUCH DISPLAY are:

- Overturn the captured image.
- Turn captured image clockwise.
- Recall main controls of main screen.
- Delete captured image (a confirmation will be requested).
- Move the captured images to a folder of the internal memory or USB (only with sensor off or in standby mode)
- Move the captured images to an iRYS folder (only with sensor off or in standby mode)
- Move the captured images to the PC (only with sensor off or in standby mode)
- Go back to the main screen without moving the captured images.

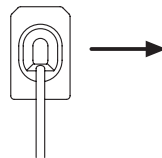
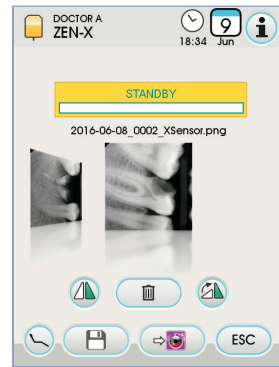
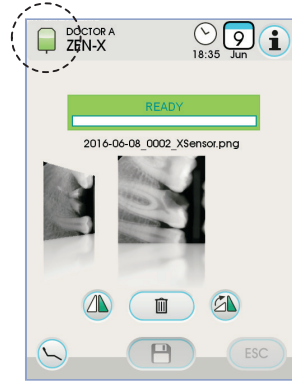
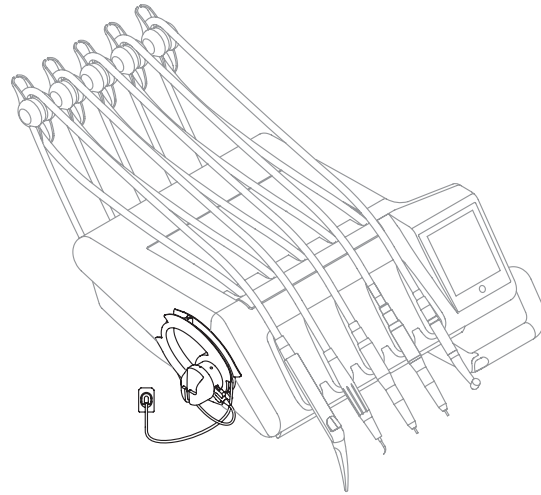

- After the first X-ray, other images can be acquired without having to carry out any other operation. Each X-ray is automatically saved inside console inner memory.

NOTE: at the end of each treatment, we recommend transferring all X-ray images inside a special folder associated to the patient.

NOTE: console internal memory can store up to approx. 1,000 X-ray images. Once the available space is running out, a warning message will appear on the TOUCH DISPLAY.

- When the ZEN-Xi sensor is turned off or set to standby mode, the screen with the X-ray images taken is still shown on the TOUCH DISPLAY, to go back to main screen, simply touch icon button .

X-ray image displaying.

The X-ray image displaying function is the same already described for the images taken by the C-U2 camera (see paragraph 5.8.).

X-ray image transfer.

The X-ray image transfer function is the same already described for the images taken by the C-U2 camera (see paragraph 5.8.).



6. Assistant's board operation

Main features:

- Two articulated arms secure the board (a) to the hydrogroup (b) allowing it to be placed in the most convenient work position.
- The pantograph arm (e) allows the assistant's board to be moved 335 mm vertically through 6 work positions.

NOTE: press button [h], found on the pantograph arm, to move the assistant's board fully down.

- The assistant's board (a) comes with a control console (d) with buttons used to operate the dental chair and hydrogroup.
- The assistant's board can be equipped with 2 suction tubes and 3 instruments.
- The assistant's board comes with sliding rollers (f) that guide and hold up the suction tubes.

NOTE: the assistant's board is equipped with a safety device that locks out dental chair movement when the board's arms are obstructed.

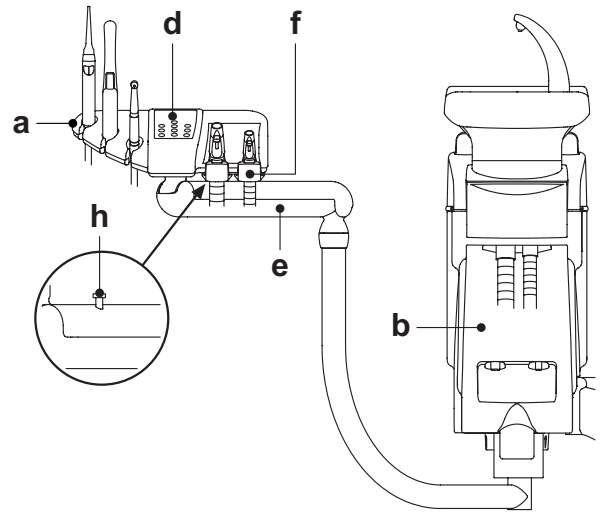

Cleaning the sliding rollers.

Push down and take off the sliding rollers (f).
Clean the sliding rollers using a suitable product: refer to Paragraph 1.4.

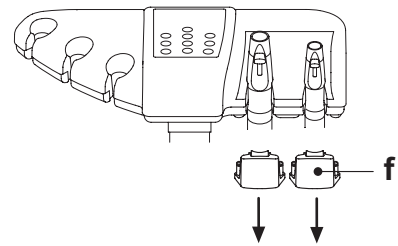

6.1. Assistant's touchpad

Description of the buttons:



Dental operator light on/off button.



Cup fill button.



Bowl rinse button.



Automatic return position retrieval button.



Rinse position button.



Programmed position 1 retrieval and chair base up button.



Programmed position 2 retrieval and chair back up button.



Programmed position 3 retrieval and chair base down button.



Programmed position 4 retrieval and chair back down button.



AS Disinfecting procedure start button.



NOTE: functioning of buttons that move the chair:

- Briefly pressed: programmed position automatically reached.
- Held down: manual positioning.



6.2. Instruments on assistant's board

All the instruments provided on the assistant's board operate in the same manner as those on the instrument board.

More specifically:

- Syringe, see paragraph 5.3.
- Turbine, see paragraph 5.4.
- Scaler, see paragraph 5.6.
- Curing light, see paragraph 5.7.
- Camera, see paragraph 5.8.

 **NOTE:** the turbine and scaler are equipped with cock [f] to adjust the water spray found under the assistant's board. The amount of air spray cannot be adjusted in the turbine.

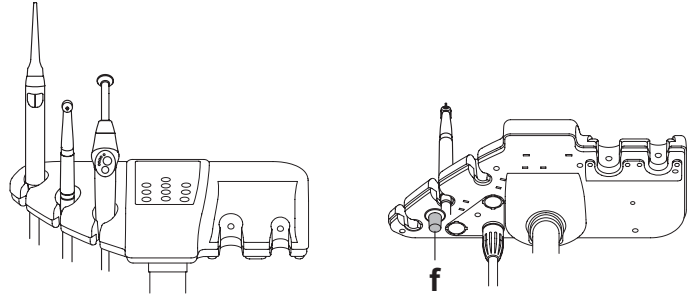

6.3. Suction tubes

To adjust the suction power, use the slider [a] located on the tube handpiece.

The dental unit is equipped with a V.D.S. system, which allows the suction line to dry by means of an automatic turn-off delay (about 2 seconds).

Cleaning the suction tubes.

As the dental units may be equipped with different suction systems (liquid ring or wet, air) carefully follow the instructions provided by the suction system manufacturer when disinfecting the system regarding the product to be used, times and directions for use.

 **WARNING!**

For cleaning of the suction system, it is recommended to use **STER 3 PLUS (CEFLA s.c.)** diluted in a 6% solution (equivalent to 60 ml of product in 1 litre of water).

Removing the suction tubes.

 **WARNING!**

Always wear gloves to prevent contact with infected material when removing the suction tubes.

Remove the suction tubes from the conveyor fittings by turning and twisting the tube fitting.
Detach the suction tubes from the holders by turning and twisting the tube fitting.

 **WARNING!**

Never directly grasp the suction tube.

Disinfection.

- Suction tube holder terminals: steam autoclave up to 135°C following the instructions for use of the device.
- Suction tubes: soak to cold sterilize.

 **WARNING!**

Never use procedures in which the temperature goes over 55 °C with the tubes.

Maintenance.

Periodically lubricate the O-rings of the cannula holder terminals (see Paragraph 9.4.) using **S1-Protective Lubricant for O-Rings (CEFLA s.c.)**.

Note about biocompatibility.

Only suction tubes supplied with the dental unit and there after original replacement tubes can be used.
The suction tubes must comply to the standard EN 10993-1 Biological evaluation of medical devices.

ISOLITE suction tube.

For ISOLITE suction tube operation, please refer to the specific use instructions given by the manufacturer.

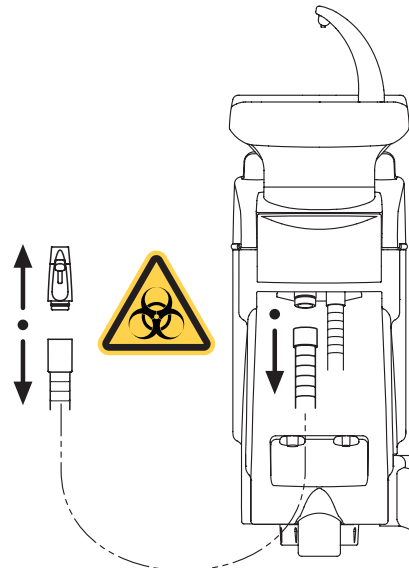
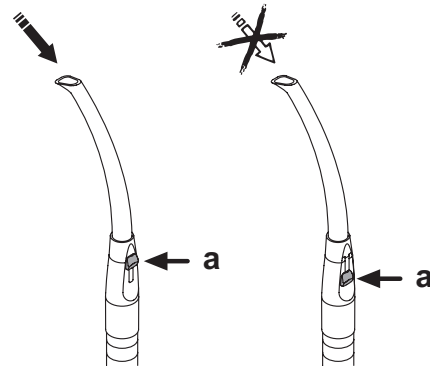
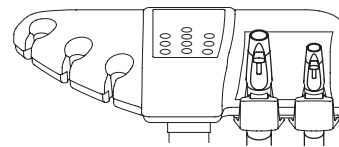



6.4. Instrument tray.

The instrument tray (**a**) is constructed in stainless steel and can be conveniently taken off its support.

The tray holder can be turned either clockwise or counter-clockwise, allowing it to be placed in the most convenient position for the operator. To lock/unlock the tray holder, simply using the clutch knob (**b**).



WARNING!

Maximum allowable load that can be applied on instrument tray: 1 Kg evenly distributed.

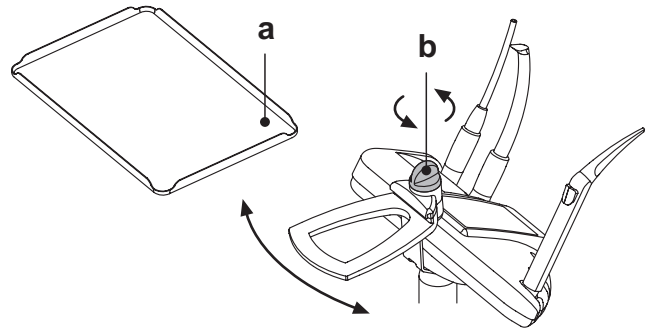

6.5. Hydraulic saliva ejector

The hydraulic saliva ejector starts running when the tube is removed from the support.

Cleaning after each use.

Aspirate about ½ litre of STER 3 PLUS (CEFLA s.c.) diluted in a 6% solution (equivalent to 60 ml of product in 1 litre of water).

Cleaning the saliva ejector filter

This operation must be carried out at the end of each work day.



WARNING!

Put on gloves before attempting to perform this operation!

- Aspirate about ½ litre of STER 3 PLUS diluted in a 6% solution (equivalent to 60 ml of product in 1 litre of water).
- In order to prevent possible dripping of liquids and secretions from the filter (**b**) to be extracted, aspirate only air for about 5 seconds.
- Take off the cap (**a**) by turning and twisting at the same time.
- Remove the filter (**b**).
- Clean/replace the filter (code 97290060).
- Put the filter and cap back in place.

Routine maintenance

Lubricate the o-rings (**c**) with **S1 – Protection for o-rings lubricant**.

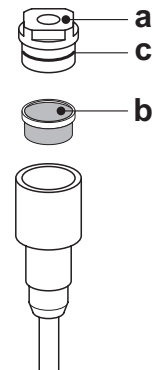
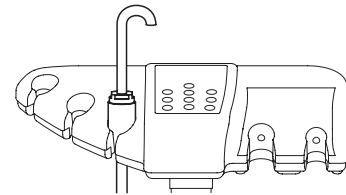



7. Hydrogroup operation

7.1. Fill cup and bowl

The bowl can freely move 305° on the hydrogroup. The bowl may be powered (optional) or can be turned by hand.
The bowl and water to cup spout can be removed to ease cleaning.

Control buttons.



Water to cup button.



Bowl flush button.

Adjusting the amount of water used to fill the cup.

See paragraph 5.1.1.2.2.2.

Adjusting the temperature of the water sent to the cup.

See paragraph 5.1.1.2.2.2.

Setting bowl flushing.

Water can be delivered to the bowl either in manual (with the ON/OFF button) or timed.

See paragraph 5.1.1.2.2.1. to set the desired mode of operation and water delivery time.

Setting automatic bowl flushing.

The bowl is automatically flushed in the following cases:

- when button "Water to cup" is pressed,
- when button "Dental chair automatic return" is pressed,
- when button "Rinse position" is pressed.

To change operation see paragraph 5.1.1.2.2.1.

Powered bowl movement.



Bowl counter-clockwise button.



Bowl clockwise button.

 **NOTE:** The bowl can also be moved directly by hand.

Automatic bowl motion (only with powered bowl).

The bowl moves automatically in the following cases:

- press button "Dental chair rinse position",

 **NOTE:** in this case, the position of the bowl can also be set (see paragraph 5.1.2.).

- by pressing button "Dental chair reset position".

See paragraph 5.1.1.2.6. for information on how to modify operation.

Removing the spouts, bowl and bowl filter.

- Pull up the spouts [l] and [n] and remove them.
- Pull up the filter [q] and its cover [p] to remove them.
- Remove the bowl [m] by first turning it counter-clockwise.

Disinfecting and cleaning.



WARNING!

Always wear gloves to prevent contact with infected material when cleaning the bowl and bowl filter.

The parts are to be cleaned daily at the end of each work day.

- Spouts and bowl: thoroughly wash with a specially formulated cleaner (for example MD 550 Orotol DÜRR).
- Bowl filter: clean with running water and commercially-available cleaning products.



WARNING!

Do not use acids or harsh products.

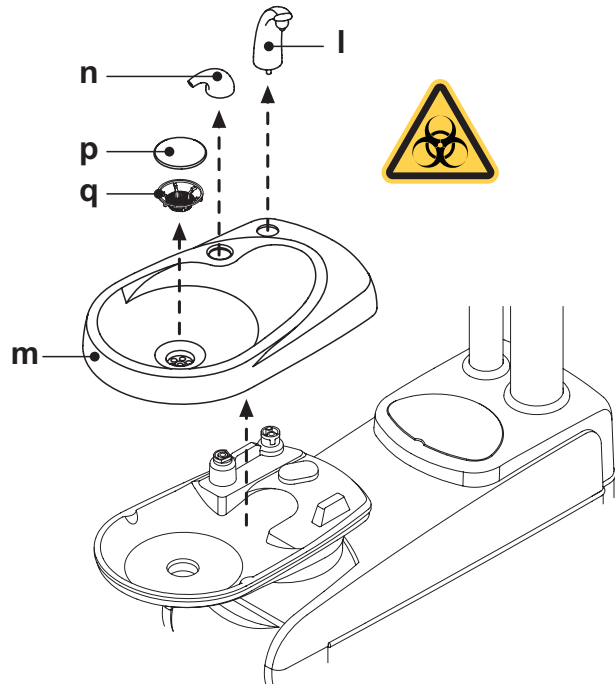
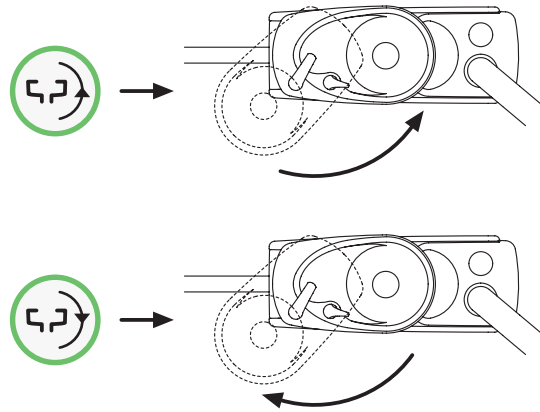
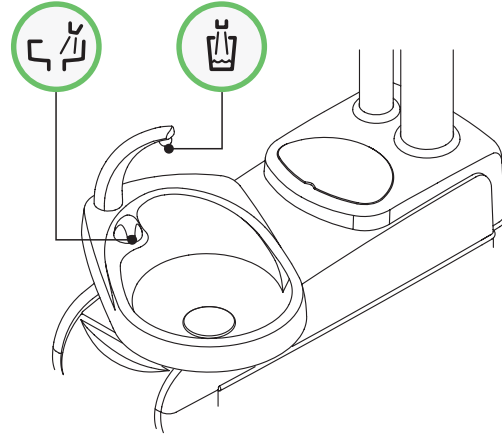



7.2 S.S.S. System

Description of the system

The S.S.S. system is equipped with a distilled water tank (a).
The tank can hold 1.8 liters.

Distilled water is delivered to:

- the sprays of all the instruments found on the instrument and assistant's board
- the syringe on the assistant's board
- to fill the cup
- water quick-connect coupler (if present)

The icon button  on the TOUCH DISPLAY (see paragraph 5.1.1.2.12.) allows to activate/deactivate the distilled water delivery.

 **NOTE:** the distilled water delivery status is shown by the icon (A) on the control panel display.

This system allows running a disinfection cycle for the instrument spray ducts (see paragraph 7.2.1.).

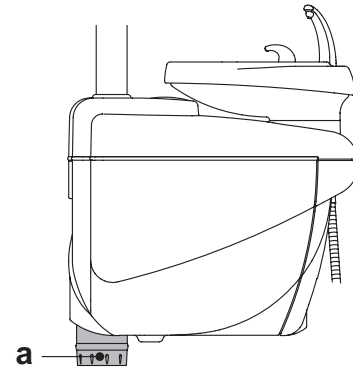



Tank reserve level.

When the liquid in the tank falls below the reserve level, the relative icon (B) appears on the instrument board's console.

Filling the tank.

When the water level in the tank is low (about 500 cc), fill it as directed below:

- Disable the S.S.S. system by touching the icon button  .
Check that the icon (B) on the console display disappears.

 **NOTE:** during this operation, the pressurized air contained in the tank will automatically be discharged to the outside.

- Turn the tank counter-clockwise (a) and remove it.
- Pour distilled water into the tank until the maximum level is reached.



WARNING!

Use only distilled water. For a higher guarantee of hygiene you can add 600 parts per million (ppm) of hydrogen peroxide using 20 ml of Peroxy Ag+ per litre of distilled water, or oxygenated water (20 ml of 3% oxygenated water per litre of distilled water).

- Put the tank back in place turning it clockwise.



WARNING!

Make sure that the tank is properly tightened.

- Touch the icon button  to re-enable the S.S.S. system and confirm that filling is complete.

Check that the icon (A) appears on the console display.



WARNING!

If you are going to be absent from the surgery for long periods of time (holidays), completely empty out the tank (a) before leaving.

Cleaning the tank.

Only the tank should be cold disinfected on a regular basis (at least once a month) using a peracetic acid based product proceeding as directed below:

- take the tank out of the dental unit and empty it;
- prepare the solution of peracetic acid based product following the instructions provided by the manufacturer;
- fill the tank up to the rim with the peracetic acid based product;
- let the peracetic acid solution soak in the tank for the time stated by the manufacturer;
- empty the peracetic acid solution from the tank;
- rinse the tank with distilled water;
- fill the tank with distilled water and, if necessary, add hydrogen peroxide or oxygenated water as described above;
- put the tank back in place in the dental unit.

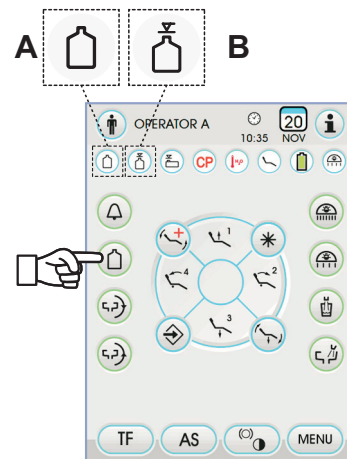



7.2.1. Manual disinfection cycle with SSS system

With the S.S.S. system, you can execute a manual disinfection cycle of the water ducts of all the instruments on the dentist's instrument board and the syringe on the assistant board.

To disinfect, proceed as directed below:

A) Prepare the disinfectant:

- Pour pure PEROXY Ag+ (or 3% oxygenated water) into the tank with the orange band without diluting it.

B) Putting in the disinfectant:

- Replace the bottle of distilled water [a] with the one containing PEROXY Ag+ (see paragraph 7.2.).

 **NOTE:** make sure there is at least 300 cc of liquid present.

- Make certain the spray cocks [d] found at the bottom of the board are opened (if they are not, either water does not come out or too little water flows out).
- Press the key to fill the cup 5 (five) consecutive times, thereby filling 5 cups with water. This step is very important as it ensures that all the distilled water in the ducts is replaced with the disinfectant liquid.
- Withdraw the instruments one at a time and let the water run for at least 2 minutes using the CHIP-WATER function of the foot control for the dynamic instruments (see paragraph 5.2) and the water key for the syringes.

 **NOTE:** at this point, the ducts contain disinfectant liquid.

- Put the instruments back in place.

C) Disinfectant contact time:



WARNING!
PEROXY Ag+ (or 3% oxygenated water) must be left to dwell in the ducts for at least 10 minutes, but not more than 30 minutes.

D) Rinsing the ducts:

- Replace the bottle containing PEROXY Ag+ with the one containing distilled water (see paragraph 7.2).
- As during the previous step, take out the instruments one at a time a let the water run at least 2 minutes using the CHIP-WATER function of the foot control for the dynamic instruments (see paragraph 5.2) and the water key for the syringes.

 **NOTE:** at this point, the ducts contain distilled water again and the dental unit is ready to be used.

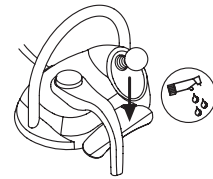
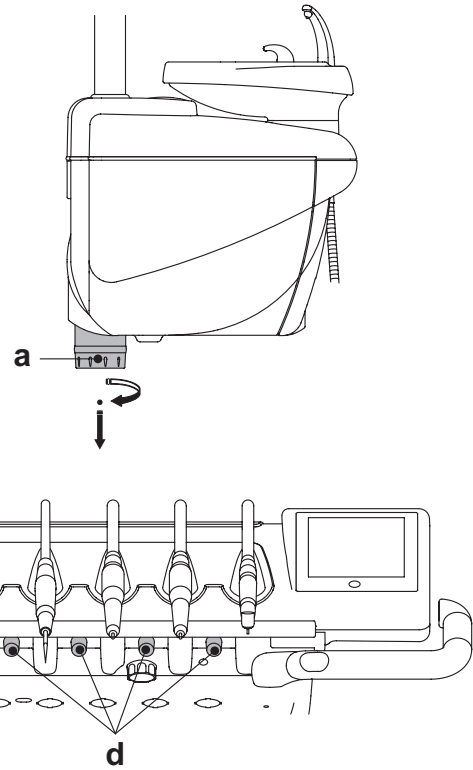

- After disinfection, make sure that you close the tank containing the disinfectant (exposed to air, it loses its effectiveness).
- It is good practice to perform a disinfection cycle at least once a day, preferably at the end of the day.
- It is strongly inadvisable to let the disinfectant dwell in the ducts for a contact time of more than 30 minutes.

PEROXY Ag+ storage.

For proper storage of PEROXY Ag+ follow the manufacturer's instructions printed on the package. It is important to keep the package tightly closed and store it in a cool place at a temperature not exceeding 25°C.



WARNING!
Never leave PEROXY Ag+ or oxygenated water in the tank (a) for longer than one month.
If you are going to be absent from the surgery for long periods of time (holidays), completely empty out the tank (a) before leaving.



7.3. M.W.B. system

The M.W.B. (Multi Water Bio controller) system assures safe separation (physically) of the dental unit water supply system from the public water mains thanks to a water free-fall section (in compliance with EN 1717). In addition, the system continuously injects hydrogen peroxide into the water circuit with a final concentration of 0.06% (600 ppm) in the ducts, suitable for bacteriostasis.

To this end, it is recommended to use **PEROXY Ag+** (CEFLA s.c.); nevertheless, 3% oxygenated water may also be used 3%.

Description of the system.

The M.W.B. system is located in the utility service center and is always active.

The system is also equipped with a tank (**a**) located in the hydro unit with a capacity of about 970 cc of disinfectant liquid.

A specific icon (**G**) on the TOUCH DISPLAY indicates when the M.W.B. system is active.

NOTE: the M.W.B. system is automatically deactivated when the S.S.S. system (if present) is activated.

Low disinfectant liquid warning signal.

When the level of disinfectant liquid in the tank (**a**) is low, a specific warning icon and an error message (**H**) appear on the TOUCH DISPLAY and 3 warning beeps are emitted, repeated each time the dental unit is turned on.

WARNING!

If the disinfectant liquid runs out, the dental unit will continue to operate but using **UNTREATED** mains water. It is advisable to as soon as possible top up the disinfectant tank.

Filling the tank containing disinfectant liquid.

When the disinfectant liquid in the tank runs out, operate as follows:

- Remove the tank [**a**].
- Remove the cap [**k**] and pour disinfectant liquid into the tank until it is full.

NOTE: the shape of the cap allows it to be used as a funnel to more easily fill the tank.

- Put the cap and tank back into place.
- Close the cover on the side of the hydrogroup.

WARNING!

Fill the tank only with pure **PEROXY Ag+** or 3% oxygenated water (10 volumes) without diluting.

M.W.B. system water circuit drainage.

This function allows draining the water circuit of the M.W.B. system if the dental unit is to remain off for many days.

The procedure for emptying the tank is given in paragraph 5.1.1.2.3.

Fault messages shown on the console display.

If the system detects a malfunction, a fault message appears on the display screen (see paragraph 10.).

If the fault found is minor, the dental unit continues to operate. On the other hand, if a serious fault is detected, the dental unit shuts down and it is necessary to call technical support.

Hydrogen peroxide storage.

For proper storage, follow the manufacturer's instructions printed on the package.

It is important to keep the package tightly closed and store it in a cool place at a temperature not exceeding 25°C.

WARNING!

Never leave **PEROXY Ag+** or oxygenated water in the tank (**a**) for longer than one month.

If you are going to be absent from the surgery for long periods of time (holidays), completely empty out the tank (**a**) before leaving.

NOTE: to empty the tank, it is advisable to use a suction cannula.

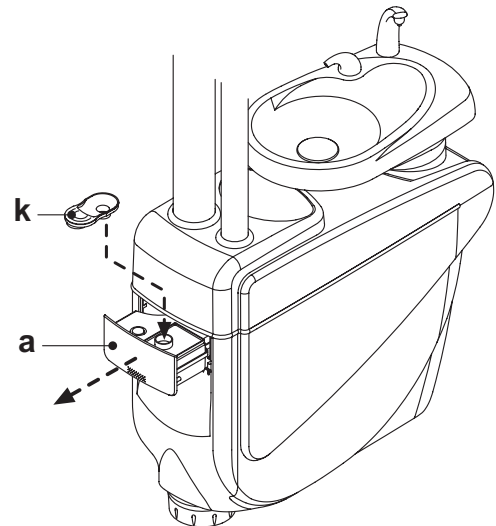



7.4. AUTOSTERIL automatic disinfection system

Description of the system.

This system performs an automatic disinfection cycle for the water circuits of the following instruments:

- all instruments found on the instrument board
- syringe on the assistant's board
- the suction cannulas (if the relevant flushing system is present),
- water to cup ducts

The system is also equipped with a tank (a) located in the hydro unit with a capacity of about 970 cc of disinfectant liquid.

The disinfection cycle can be set and is equipped with an electronic safety system in compliance with CEE 93/42 Medical Device Directive and subsequent changes.

! WARNING!

Perform a disinfecting cycle at the end of each work day.

Low disinfectant liquid warning signal.

When the level of disinfectant liquid in the tank (a) is low, a specific warning icon and an error message (H) appear on the TOUCH DISPLAY and 3 warning beeps are emitted, repeated each time the dental unit is turned on.

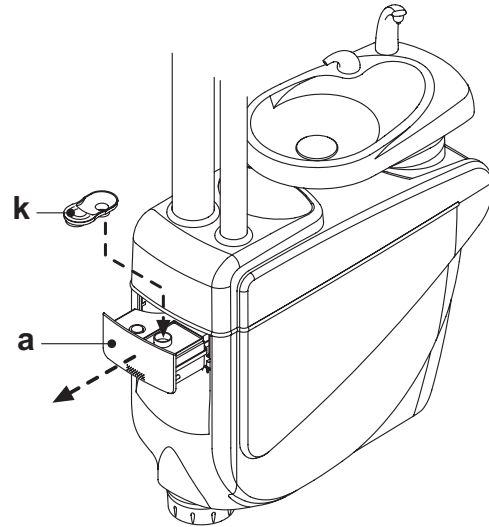

Filling the tank containing disinfectant liquid.

When the disinfectant liquid in the tank runs out, operate as follows:

- Remove the tank [a]
- Take off the cap [k] and pour hydrogen peroxide into the tank until it is full.

NOTE: the shape of the cap allows it to be used as a funnel to more easily fill the tank.

- Put the cap and tank back into place.
- Close the side cover of the hydrogroup.

! ATTENZIONE!

Per il rifornimento utilizzare solamente PEROXY Ag+ oppure acqua ossigenata al 3% (10 volumi) puri, senza diluire.

Setting the disinfection cycle.

- Make sure the level of disinfectant in the tank is correct, top up if necessary.

NOTE: The disinfection cycle will not start if the level in the tank is under reserve.

- Using the TOUCH DISPLAY or pressing and holding (for at least 2 seconds) the AS button on the assistant's board, access the AUTOSTERIL DISINFECTION CYCLE SETTING menu and set the disinfectant liquid dwell time in the water ducts of the instruments (see paragraph 5.1.1.2.1.).
- Place the instruments to be disinfected in the container provided in the hydrogroup.

! WARNING!

Use the adapter (f) provided for the syringe. The heater should be turned off.

The micromotor should be put in without the handpiece.

- In order to disinfect the suction tubes, insert the suction tube terminals in the fittings found underneath the manifold (see paragraph 7.5.).

NOTE: make sure the suction tube terminals are opened.

- If the water to cup ducts need to be disinfected, place the container (e) provided under the cup spout.
- Make sure the spray cocks (g) found under the instrument board are open.

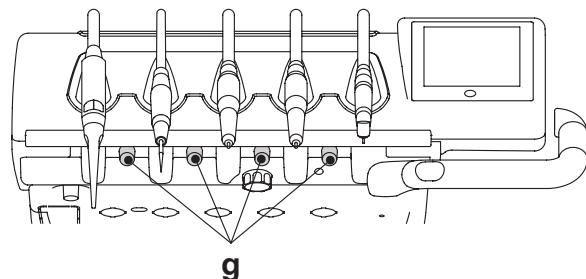
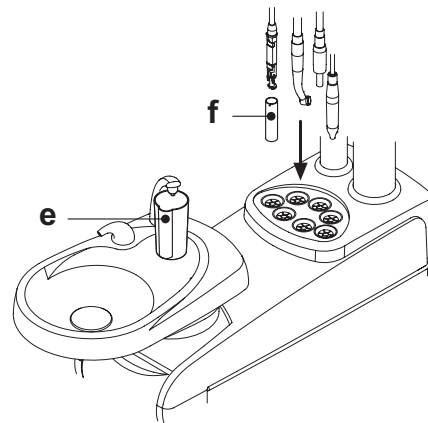



Starting the disinfection cycle.

- Start the automatic disinfection cycle by touching the icon button **PLAY** (see paragraph 5.1.1.2.1.) on the TOUCH DISPLAY or pressing the AS button on the assistant's board.
- At this point, the system performs the following steps automatically:
 - water ducts for instruments emptied with air;
 - disinfectant let in and time it has to remain in the ducts previously set starts to clock down;
 - once this time is over, ducts are emptied with air again;
 - tubing flushing with mains water or distilled water (only with the distilled water delivery system present and active).
- At the end of the disinfection cycle (the TOUCH DISPLAY shows the message "End of cycle: replace instrument") it is sufficient to replace the extracted instruments to go back to the working condition.

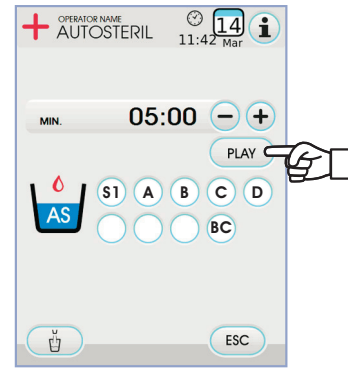

Interrupting the disinfection cycle.

- You can interrupt the disinfection cycle at any time by touching the icon button **STOP**.
- A confirmation message appears on the console display:
 - Touching the icon button **ESC** cancels interruption of the disinfection cycle and returns to display of the cycle menus.
 - Touching the icon button **ENTER** interrupts the disinfection cycle and displays an intermediate menu showing the time set and the instruments extracted.

NOTE: at this point, the dental unit is in locked status.

- The following selections can now be made:
 - Touch the icon button **ESC** to return to the initial time setting menu where you can restart the disinfection cycle from the beginning and change, if you want, the disinfectant dwell time and/or add instruments to be disinfected,
 - By touching the icon button **↺**, it is possible to enter the "Instrument flushing" menu to carry out the flushing of the extracted instruments ducts,
 - Touch the icon button **PLAY** to resume the disinfection cycle from the point where it was interrupted.
- In the "Instrument flushing" menu:
 - In the "Instrument flushing" menu, **PLAY** by touching the icon button, it is possible to activate the emptying and flushing cycle of the extracted instruments ducts with mains or distilled water (if the S.S.S. system is present),
 - Touching the icon button **↺** you return to the previous menu.

NOTE: Once the disinfection cycle has been completed ("Cycle completed: put instruments back in place" appears on the display) simply put the instruments removed back into place to resume work.

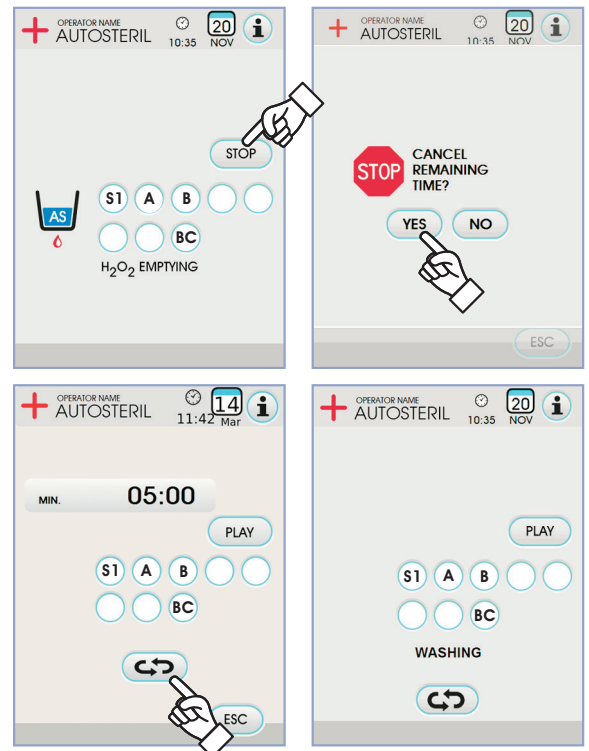

PEROXY Ag+ storage.

For proper storage of PEROXY Ag+ follow the manufacturer's instructions printed on the package.

It is important to keep the package tightly closed and store it in a cool place at a temperature not exceeding 25°C.



WARNING!

Never leave PEROXY Ag+ or oxygenated water in the tank (a) for longer than one month.

If you are going to be absent from the surgery for long periods of time (holidays), completely empty out the tank (a) before leaving.

NOTE: to empty the tank, it is advisable to use a suction cannula.

Error messages shown on the console display.

If the system detects a malfunction, a fault message appears on the display screen (see paragraph 10.).



WARNING!

If the disinfecting cycle is incorrectly interrupted, the equipment will shutdown until either the disinfecting cycle is performed again or the washing cycle is carried out.

7.5. TIME FLUSHING automatic cycle

Description of the system.

The TIME FLUSHING system allows executing an automatic flushing cycle (FLUSHING) to refresh the water in the water ducts of the instruments on the dentist's and the assistant's boards and the water-to-cup duct. Flushing may be carried out with mains water, treated water (if the M.W.B. system is present) or distilled water (if the S.S.S. system is present) The cycle duration can be set up from 1 to 5 minutes.

⚠ WARNING!

It is advisable to execute a flushing cycle at the beginning of each working day and in the interval between one patient and the next.

Setting the flushing cycle.

- If the S.S.S. system is present and you want to execute the flushing cycle with distilled water, check that the relative icon (**A**) on the console display is on (see paragraph 7.2.).

👉 NOTE: it is advisable to execute the flushing cycle with a full tank of distilled water.

- By using the TOUCH DISPLAY, enter the "TIME FLUSHING cycle setting" menu and set the cycle duration (see paragraph 5.1.1.2.2.).
- Place the instruments to be treated in the container provided in the hydrogroup.

⚠ WARNING!

Use the adapter [**f**] provided for the syringe. The heater should be turned off.

The micromotor should be put in without the handpiece.

- Insert the special supplied container (**e**) under the cup spout.
- Make sure that the spray taps (**g**) in the lower part of the dentist's instrument board are open.

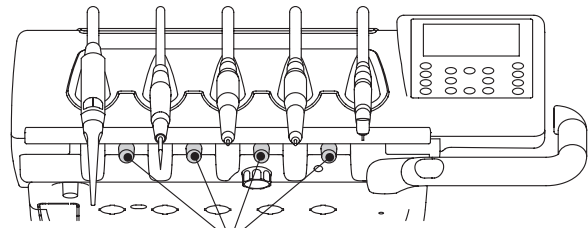
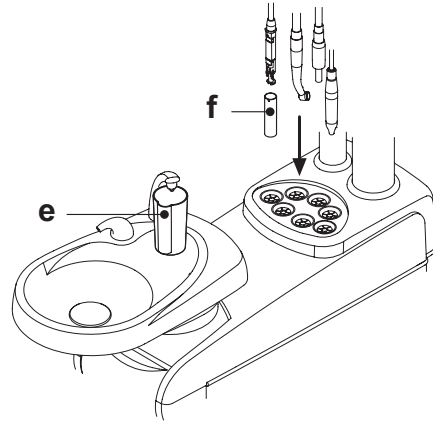

Executing the flushing cycle.

- Start the flushing cycle by touching the icon button **PLAY** on the TOUCH DISPLAY (see paragraph 5.1.1.2.2.).
- At the end of the flushing cycle (the display shows the message "End of cycle: put back instruments"), put the instruments extracted back into place to return to the working condition.

Interrupting the flushing cycle.

You can interrupt the flushing cycle at any time **STOP** by touching the icon button and return to the initial cycle setting menu.

Error messages shown on the console display.

If the system detects a malfunction, a fault message appears on the display screen (see paragraph 10.).

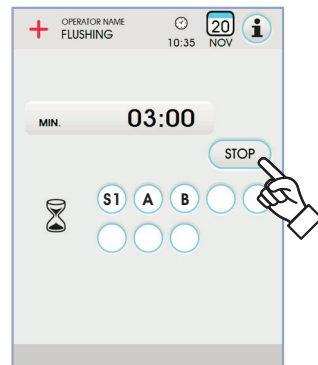
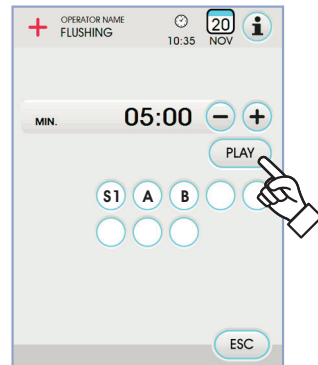



7.6. S.H.D. system for flushing the suction tubes

Description of the system.

The S.H.D. (Suction Hoses Disinfection) system allows cleaning the surgical suction system.

The system comes with a tank (**c**) that contains the liquid disinfectant and two fittings (**d**) used to wash the suction tubes.

The tank containing the detergent liquid has a total capacity of 500 cc.

The washing cycle is automatically carried out and should usually be performed at the end of each surgical procedure and whenever the dental unit is cleaned and disinfected.



WARNING!

It is recommended to use **STER 3 PLUS (CEFLA s.c.)** as detergent liquid, diluted in a 6% solution (equivalent to 60 ml of product in 1 litre of water).

How to start the washing cycle.

To start the washing cycle, follow the directions given below:

- Check that the tank (**c**) contains the detergent liquid.
- Remove both suction tube terminals from the assistant's board, making sure the suction motor starts running.
- Open the mechanical closing of the suction tube terminals.
- Insert the terminals in the fittings (**d**) found under the manifold.
The vacuum created by the Venutri meters triggers the washing cycle.
- Washing cycle stages:
 - deliver municipal water for 50 sec. using intermittent operation (2 sec. ON - 1 sec. OFF);
 - stop the water flow and let in 10 cc of liquid disinfectant;
 - stop letting in liquid disinfectant and continue sucking for 10 sec.
- The washing cycle ends when the suction flow is interrupted and the motor stops running.
"Put the suction tubes back in place" appears on the display.
- At this point, put the ends of the suction tubes in the supports on the assistant's board to go back to the work conditions.

Filling the tank.

If the detergent liquid in the tank [**c**] is below the minimum level, act as follows:

- Raise the patient chair to maximum height.
- Remove the tank by rotating it anticlockwise.
- Pour the detergent liquid into the tank until it is full.
- Re-fit the tank; screw it on clockwise.

Stopping the washing cycle.

If the system detects a malfunction, a fault message appears on the display screen (see paragraph 10.).



NOTE: Once the problem has been solved, the washing cycle automatically restarts.

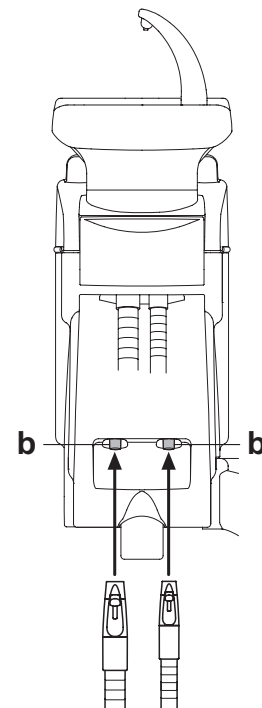
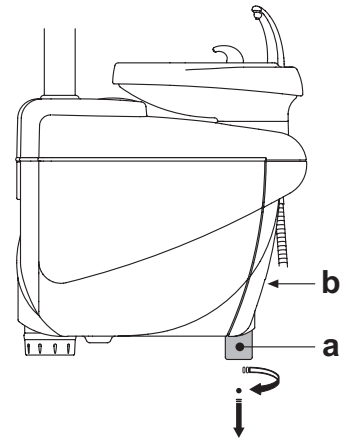



7.7. Opening/closing the cover at the side of the hydrogroup

Opening the cover:

- Grasp the handle [h] and pull it up to unlock the cover [a] at the side of the hydrogroup.
- Turn the cover outwards to open it.

Closing the cover:

- Press the handle [h] to block the cover until a click is heard.

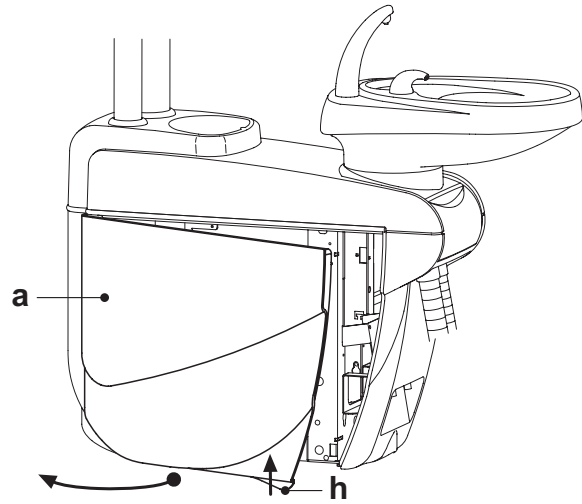



8. Accessories

8.1. Operating lamp

The operating lamp comes in 2 models:

- ① Lamp with halogen light source – model VENUS PLUS.
- ② Lamp with LED light source – model VENUS PLUS-L.

The instructions for use and maintenance of the lamps are available in PDF format and can be downloaded from the download area of the website www.castellini.com.

NOTE: During the automatic movements of the dental chair, the lamp automatically turns off to prevent blinding the patient.

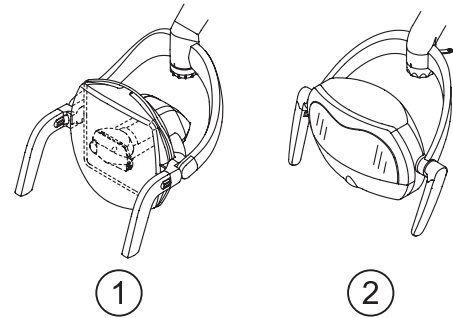

8.2. Monitor on lamp pole

The instructions for use and maintenance of the monitor are provided with the device.

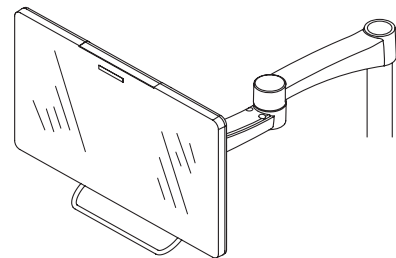

8.3. Negatoscope for panoramas

An x-ray film viewer for panoramic x-rays can be mounted on all CP version instrument boards. The screen dimensions are as follows: H=210mm, L=300mm. Per accendere il negatoscopio è sufficiente agire sull'apposito interruttore (a):

- = negatoscope on
- = negatoscope off

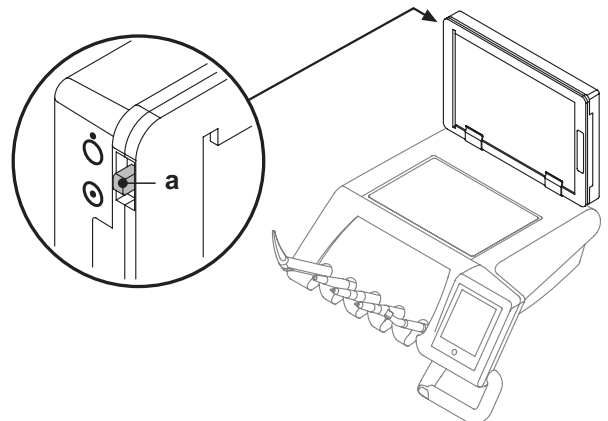

8.4. Air/water/230V quick-connect couplers

The air/water/230V quick-connect couplers are placed to the side of the electrical box.

WARNING!
Shut off the equipment before attempting to connect or disconnect the air/water outlets.

Technical specifications.

- Power outlet: 230VAC 2A in accordance with IEC/EN 60320-2-2/F (only on dental units with 230 VAC power supply).
- Air quick-connect coupler pressure: 6 Bar.
- Water quick-connect coupler pressure:
 - municipal water, 2.5 Bar
 - with S.S.S. system, 1,8 Bar
 - with M.W.B. system, 3 Bar
- Water quick-connect coupler delivery rate:
 - municipal water, 1800 ml/min
 - with S.S.S. system, 950 ml/min
 - with M.W.B. system, 400 ml/min

NOTE: with S.S.S. system: to use the quick-coupling with mains water, disable the distilled water tank (see Paragraph 7.2.)

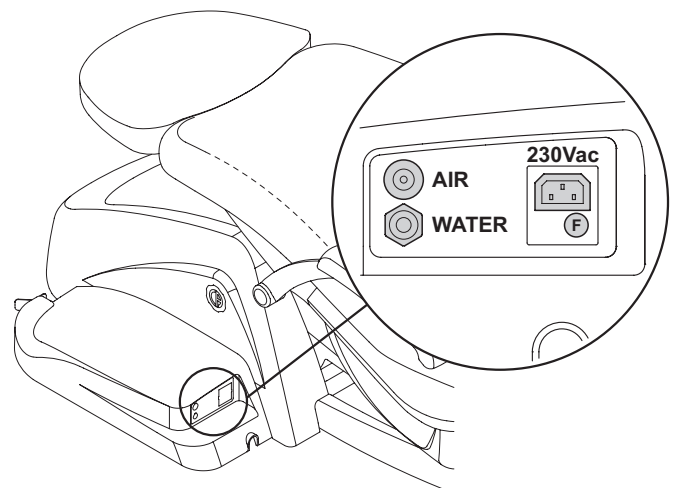



8.5. H.P.A. filter (Hight Protected Air)

The H.P.A. filter [h] holds back any bacterial load present in the air line directed to the instrument sprays.



WARNING!

- The filter element is not sterile when supplied;
- Use disposable gloves when replacing parts;
- The transparent ampule does not stand up to alcohol. Clean the ampule with neutral detergent and hot water.

Care

- Sterilize the element every month.



WARNING!

Sterilize in steam autoclave up to 135°C following the instructions for use of the device.

Do not use dry sterilizers.

- Replace the element once a year or after 200 sterilization cycles.

Removing the filter element

- Move the dental chair completely up;
- Shut off the dental unit with the main switch (see paragraph 3.);
- Operate the syringe until the air pressure has been discharged;
- Remove the safety lock [s] found to the side of the ampule by pulling it down;
- Turn the transparent ampule [v] counter-clockwise to disengage it;
- Remove the filter element [t] by pulling it down.
- Sterilize/replace the filter element (code FH4200025).
- Put the filter element [t] back into place;
- Put the transparent ampule [v] back into place turning clockwise to engage it.
- Put the safety lock [s] back in place.

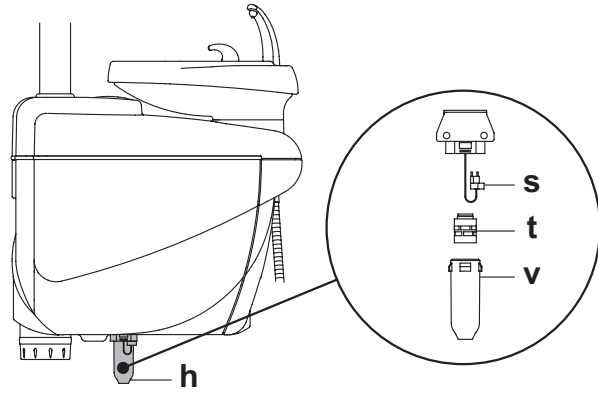



9. Maintenance

Preventive maintenance.

CEFLA s.c., the manufacturer of the dental units, in accordance with applicable standards IEC 60601-1 2.a Ed., IEC 62353 and directive MDD 93/42 and subsequent changes for medical devices underlines that the preventive maintenance checks for the dental unit specified in the Technical care manual and Maintenance and warranty handbook are to be carried out by authorised personnel at least once every 12 months.



WARNING!

The warranty is void if the equipment is serviced, repaired, altered or modified in any way by personnel who have not been duly authorized by CEFLA s.c.

Safety checks.

In accordance with standard IEC 62353, the safety checks specified in the Technical care manual and Maintenance and warranty handbook supplied with the dental unit are to be carried out at the intervals required by current local regulations. If no precise indications are given, CEFLA s.c., the manufacturer of the dental units, recommends checking them at least every 24 months at the time of installation and whenever electrical parts that are live are repaired/updated.



WARNING!

The manufacturer shall not be held liable for any personal injury or equipment damage if the precautions given above are not observed.

9.1. Instrument maintenance

Maintenance instructions for the instruments are enclosed with each instrument.



WARNING!

Maintenance of the instruments should be carried out with the equipment shut off.

9.2. Draining condensate

Perform this operation every day before starting work.

Proceed as follows:

- put a container under the cock [a] found below the hydrogroup,
- loosen the cock's knob
- once emptied, completely close the cock.

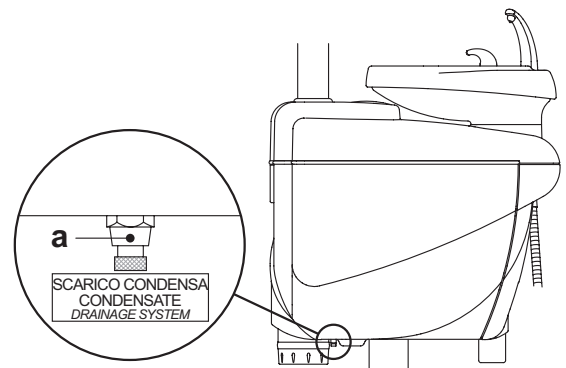

9.3. Cleaning the surgical suction filter

This operation should be done daily at the end of work.



WARNING!

Always wear gloves to prevent contact with infected material when cleaning the suction filters.

Proceed as follows:

- Open the door [c] that protects the filters.
- Take out the two filters [d].
- Clean/replace the filter (code 97461845).



NOTE: the door [c] can be taken off and used as a tray for the filter removed.

- Put the two filters back in place being careful to remove any amalgam left at the seat of each filter.
- Close the door [c].



NOTE: To prevent liquids and matter from dripping from the filter taken out, perform the operations given above with the suction tube running.

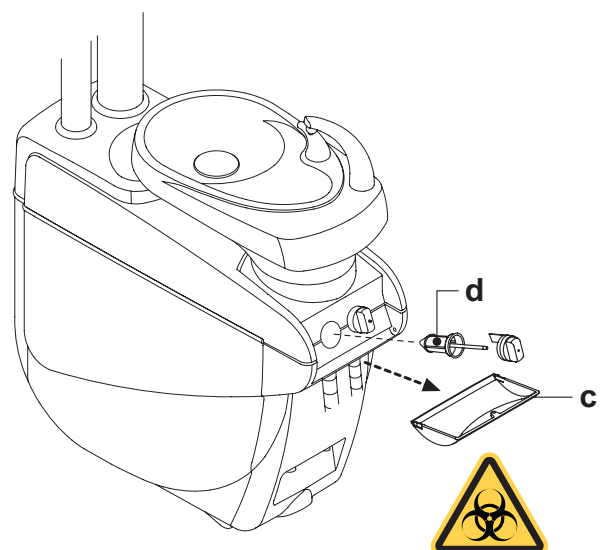



9.4. Surgical suction

The surgical suction system must be sanitized using a product suitable for this purpose.

WARNING!

For cleaning of the suction system, it is recommended to use STER 3 PLUS (CEFLA s.c.) diluted in a 6% solution (equivalent to 60 ml of product in 1 litre of water).

At the end of each surgical procedure.

- Execute an automatic flushing cycle or aspirate about ½ litre of sanitizing solution with each of the cannulas used.
- Sterilize the suction tube holder terminals in a steam autoclave up to 135°C following the instructions for use of the device.

At the end of each work day.

- Draw in 1 liter of water with each suction tube, alternating water and air (keep the suction tube alternately in and out of the water).
- After rinsing with water, execute an automatic flushing cycle or aspirate about ½ litre of sanitizing solution with each of the cannulas used.

WARNING!

Whatever sanitizing product you use, follow the instructions given by the manufacturer.

 **NOTE:** After these operations, it is advisable to aspirate only air in order to dry the entire suction system (5 minutes).

Once a week.

Remove the cannula body from its cord attachment and lubricate the O-rings (o) using **S1-Protective Lubricant for O-Rings** (CEFLA s.c.).

Once a year.

Replace the suction tubes and ends of the tube holder.

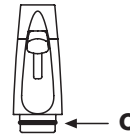
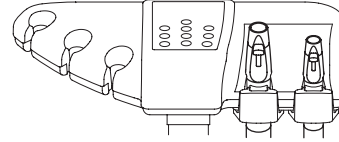



9.5. CATTANI surgical separator

At the beginning of each working day.

Insert a tablet [v] into each filter [d] of **VF CONTROL PLUS** (CEFLA s.c.).



WARNING!

ALWAYS wear gloves when carrying out this operation to prevent any contact with infected material.

At the end of each surgical procedure.

- Execute an automatic flushing cycle or aspirate about ½ litre of sanitizing solution with each of the cannulas used.
- Sterilize the suction tube holder terminals in a steam autoclave up to 135°C, minimum time 15 min.

At the end of each work day.

- Draw in 1 liter of water with each suction tube, alternating water and air (keep the suction tube alternately in and out of the water).
- After rinsing with water, execute an automatic flushing cycle or aspirate about ½ litre of sanitizing solution with each of the cannulas used.

NOTE: After these operations, it is advisable to aspirate only air in order to dry the entire suction system (5 minutes).

Every 15 days.

- Clean the separator container and probes with a soft sponge and neutral detergent.
- Clean the drain valve for the separator's container with the device provided for this purpose.

Once a year.

- By technician: check the siphons and drains, check all the internal tubes and plastic and rubber parts subject to wear.

Before leaving the surgery empty for a few days.

- Start the aspirator and run it 20 - 30 minutes without sucking in liquids. The aspirator will dry itself completely. As a result, salt caused by moisture and basic substances will not form, salt that may cause fan seizure and motor blockage.

How to remove the separator's container.



WARNING!

Gloves must be worn when carrying out the following operation to prevent contact with infected material.

- Move the dental chair fully up.
- Open the cover at the side of the hydrogroup [a] (see paragraph 7.7) and turn the electrical box [b].
- Turn the electrical box [b] and hydrogen peroxide tank [a] (if present).
- Completely empty the separator's container by pressing the timed button [c] found on the cover.
- If present, remove the valve [s] for central systems.
- Turn and raise the container until it is detached from the drain pump (k).
- Detach the container [d] from the cover [f] by pulling up the two side elastic bands [e].
- After the cleaning operations, refit the vessel [d] after lubricating the O-rings with S1-Protective Lubricant for O-Rings (CEFLA s.c.).
- Put the electrical box [b] back in place and put the cover [a] back on the side of the hydrogroup (see paragraph 7.7).

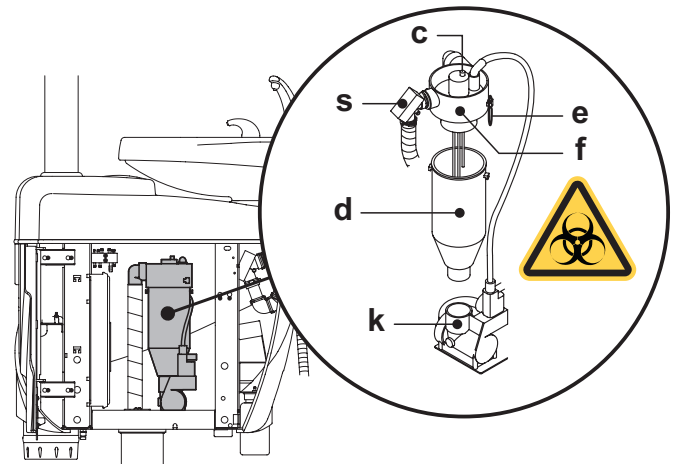
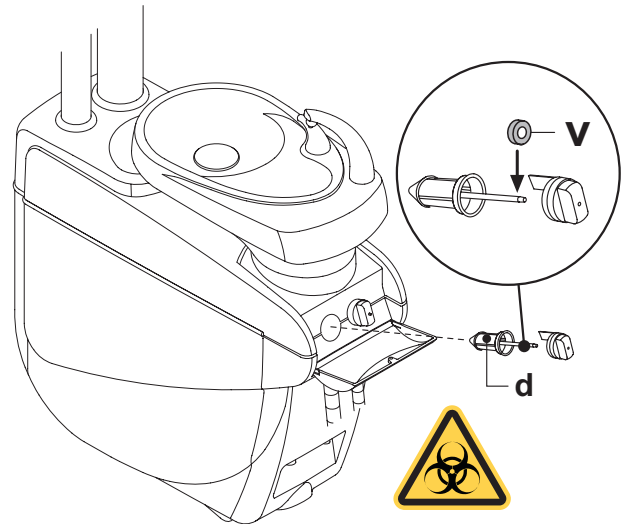

Drain pump locked warning.

A dedicated icon (**A**) on the TOUCH DISPLAY will indicate if the drain pump below the separator vessel locks.

At this point, shut off the equipment and empty the separator bowl by hand. If the icon appears again, call technical service.

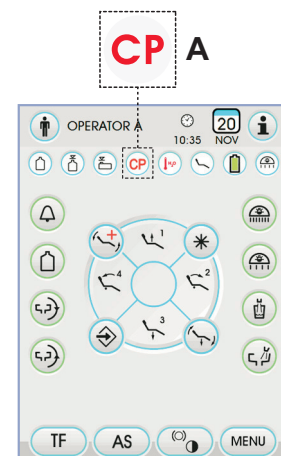



9.6 Cleaning the turbine return air filter

Monthly check the oil container filter (**g**) present in the turbine's return air line.
If necessary, replace the filter element (code 97290014).

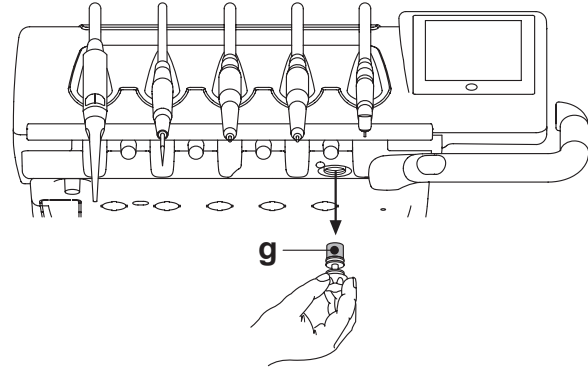

9.7. METASYS amalgam separator

The maintenance instructions for the METASYS amalgam separator are enclosed with the equipment if the equipment comes with this type of separator. The separator's control device is located in the hydrogroup.



WARNING!

Always wear gloves to prevent contact with infected material when cleaning the separator.



WARNING!

When disposing one-time use containers full of amalgam, observe current local and national laws.

9.8. DÜRR amalgam separator

The maintenance instructions for the DÜRR amalgam separator are enclosed with the equipment if the equipment comes with this type of separator. The separator's control device is located in the hydrogroup.



WARNING!

Always wear gloves to prevent contact with infected material when cleaning the separator.



WARNING!

When disposing one-time use containers full of amalgam, observe current local and national laws.

9.9. Dental chair

The dental chair does not require any particular maintenance.
It is nevertheless advisable to once a year have an authorised CASTELLINI technician check overall functioning.



10. Fault messages

M = Message shown on console display
C = Cause
R = Remedy

M: "H2O level low, fill tank"

C: The water in the independent water system's tank has dropped below the minimum acceptable level.
R: Fill the tank (see paragraph 7.2.).

M: "Put instruments back in place"

C: The system detected an instrument was already withdrawn while the disinfecting cycle was being set.
R: Make sure all the instruments are in place and then set the cycle again. If the fault message appears again, call technical support.

M: "Check instruments, repeat cycle"

C: The system detected the withdrawn instruments were altered during the flushing or disinfecting cycle.
R: Check the selected instruments and repeat the disinfecting (see paragraph 7.4.) or flushing (see paragraph 7.5.) cycle.

M: "H2O2 level low, fill tank"

C: The hydrogen peroxide in the relative tank has dropped below the minimum acceptable level.
R: Fill the hydrogen peroxide tank (see paragraph 7.4.).

M: "Open H2O spray cocks"

C: The system is not able to fill the lines with hydrogen peroxide during the disinfecting cycle.
R: Open the water spray cocks and repeat the disinfecting cycle (see paragraph 7.4.). If the message appears again, call technical support.

M: "Remove all instruments"

C: The system detected an internal malfunction during the disinfecting cycle.
R: Repeat the disinfecting cycle, selecting all the instruments. If the message appears again, call technical support.

M: "Empty M.W.B. system"

C: M.W.B. system malfunction.
R: Empty the tank inside the M.W.B. system and restart the system (see paragraph 5.1.1.2.3.). If the message appears again, call technical support.

M: "Turn on M.W.B."

C: The system is attempting to perform a task which requires that the M.W.B. system is turned on.
R: Turn on the M.W.B. system (see paragraph 7.3.).

M: "Check suction tubes, repeat cycle"

C: The system has detected that the suction tubes are not connected to the relative fittings during the flushing or disinfecting cycle.
R: Make sure the suction tubes are properly connected and repeat the disinfecting (see paragraph 7.4.) or flushing (see paragraph 7.5.) cycle. If the message appears again, call technical support.

M: "Withdraw at least one instrument"

C: An attempt has been made to start a disinfecting cycle without selecting any instruments or the cup.
R: Repeat the disinfecting cycle selecting at least one instrument or the cup. If the message appears again, call technical support.

M: "Instrument configured"

C: The instrument in the indicated position on the board has been automatically configured with the factory settings.
R: If the message appears again, call technical support.

M: "Put suction tubes back in place"

C: Suction tubes extracted when dental unit is turned on.
R: Make sure the suction tubes are correctly placed in their housings. If the message appears again, call technical support.

M: "Put instrument back in place"

C: Instrument extracted when dental unit is turned on.
R: Make sure all the instruments are correctly placed in their housings. If the message appears again, call technical support.

M: "Check suction tube filter"

C: Suction tube flushing cycle malfunction.
R: Make sure the filters are clean, the suction tubes are not closed and that the suction unit works correctly and then repeat the flushing cycle. If the message appears again, call technical support.

M: "Hydrogroup emergency device activated"

C: While performing an automatic movement, the assistant's board encountered an obstacle.
R: Clear the obstacle and press the button for the desired program again.

M: "Lower dental chair"

C: The bowl does not move because the dental chair is in its way.
R: Lower the dental chair so that it is no longer in the way.

M: "Check operating light fuses"

C: The operating light does not turn on because electric power is not supplied.
R: Call technical support.

M: "Maintenance required"

C: Scheduled maintenance required.
R: Call technical support to schedule the maintenance work.

M: "Footboard emergency device activated"

C: The dental chair encountered an obstacle.
R: Press the "seat up" button and clear the obstacle.

M: "Backrest emergency device activated"

C: The dental chair backrest encountered an obstacle.
R: Press the "seat up" button and clear the obstacle.

M: "Move bowl"

C: The dental chair does not move because the bowl is in the way.
R: Move the bowl so that it is no longer in the way of the dental chair.

M: "Seat emergency device activated"

C: The dental chair encountered an obstacle.
R: Press the "seat up" button and clear the obstacle.

M: "Delivery emergency device activated"

C: The side delivery board encountered an obstacle.
R: Press the dental chair "seat up" button and clear the obstacle.

M: "Dental chair blocked, put instrument back in place"

C: An attempt was made to move the dental chair with an instrument withdrawn.
R: Put instrument back in place and repeat dental chair movement.

M: "Dental chair blocked"

C: An attempt was made to move the dental chair while it was blocked
R: Remove dental chair blockage (see paragraph 4.).



IMPORTANT INFORMATION!

M: "XXXX, call technical support" (where XXXX represents a numerical code)

C: This type of message indicated a serious internal error.

R: Call technical support quoting the number of the error.



11. Specifications

Installation plan:	SKEMA 6	97042072
	SKEMA 8	97042081
Technical manual:	SKEMA 6	97071165
	SKEMA 8	97071166
Dental unit spare parts catalogue:	97023126	
Dental chair spare parts catalogue:	97023126	
Maximum dental unit weight:	90 Kg.	
PMaximum dental chair weight:	NEW SKEMA	115 Kg.
	THESI 3	135 Kg.
Maximum dental chair capacity:	190 Kg.	
Voltage:	230V~	
Frequency:	50/60 Hz.	
Power absorbed:	1500W	
Air connection:	1/2 Gas.	
Air supply pressure:	6-8 bar.	
Air delivery rate:	82 l/min.	
Water connection:	1/2 Gas.	
Water supply pressure:	3-5 bar.	

Water delivery rate:	10 l/min	
Water usage:	2 l/min.	
Water hardness:	< 25 °f (14 °d)	
Drain connection:	ø40 mm.	
Drainage rate:	10 l/min.	
Drain duct inclination:	10 mm/m.	
Aspirator connection:	ø40 mm.	
Vacuum (minimum):	65 mbar.	
Vacuum delivery rate:	450 l/min.	
Mark of approval:	CE 0051	
Electrical work in compliance with:	IEC 60364-7-710	
Dental unit packaging dimensions:	1570 x 780 x 1325(h)	
Dental chair packaging dimensions:	1510 x 730 x 1000(h)	
Dental unit packaging weight:	140 Kg.	
Dental chair packaging weight:	NEW SKEMA	150 Kg.
	THESI 3	170 Kg.

FUSES			
Identification	Value	Protection	Position
<i>Dental unit.</i> Fuse F2 Fuse F4 Fuse F5 Fuse F6	T 12,5 A T 6,3 A T 6,3 A T 6,3 A	230 V~ : Dental unit power supply line. Secondary protection: Hydrogroup. Secondary protection: Dental unit. Secondary protection: Operatory light.	Electrical box. Electrical box. Electrical box. Electrical box.
<i>Dental chair.</i> Fuse F1	T 6,3 A	230 V~ : Dental chair power supply line.	Electrical box.
<i>Quick-connect couplers.</i> Fuse	T 2 A	230 V~ : Electrical outlet power supply line.	Electrical box.
MONITOR power supply. Fuse	T 4 A	21 V~: Monitor power line.	Dental chair card area.



11.1. SKEMA 6 dimensional characteristics

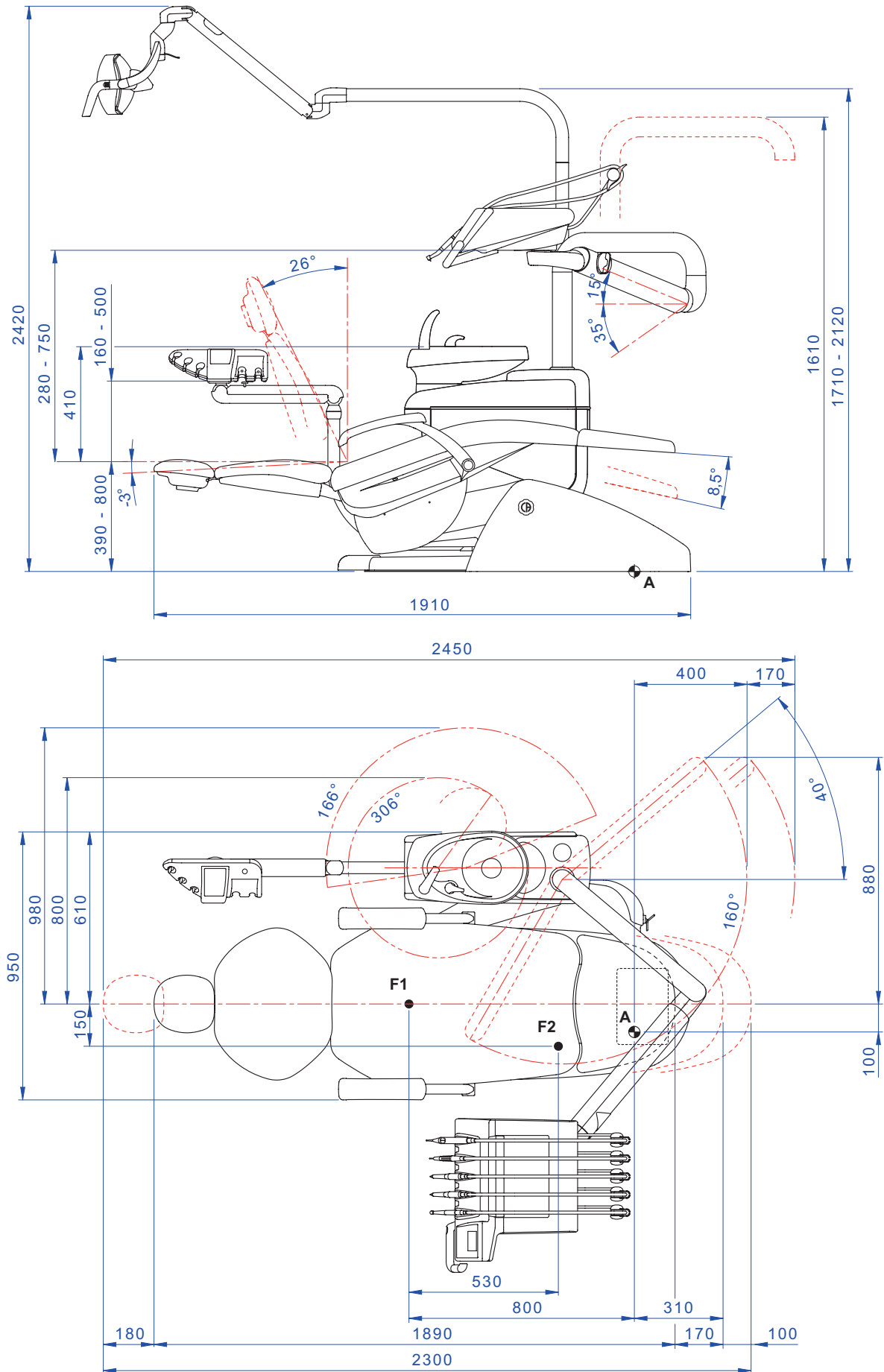



11.2. Overall dimensions SKEMA 6 CP

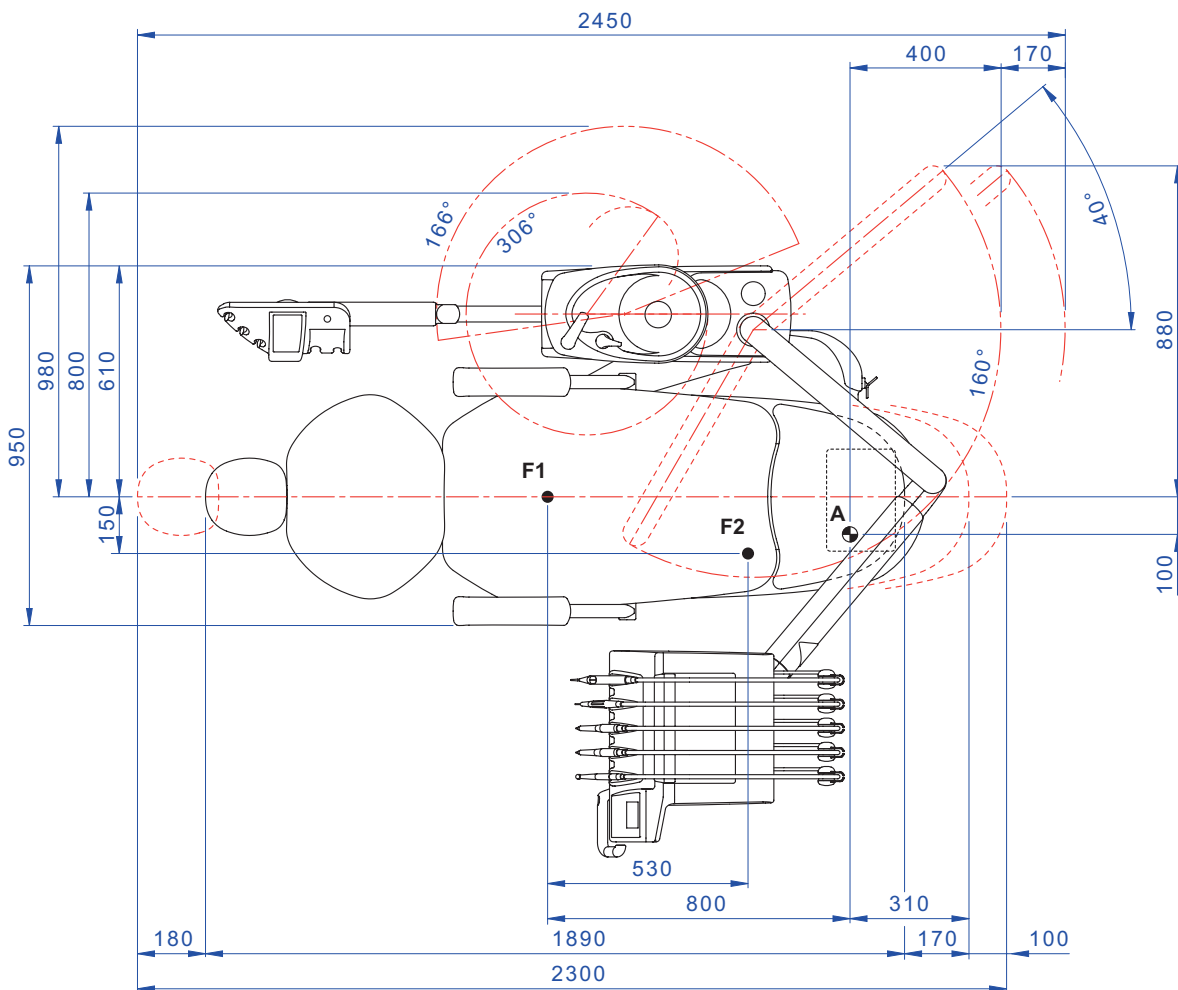
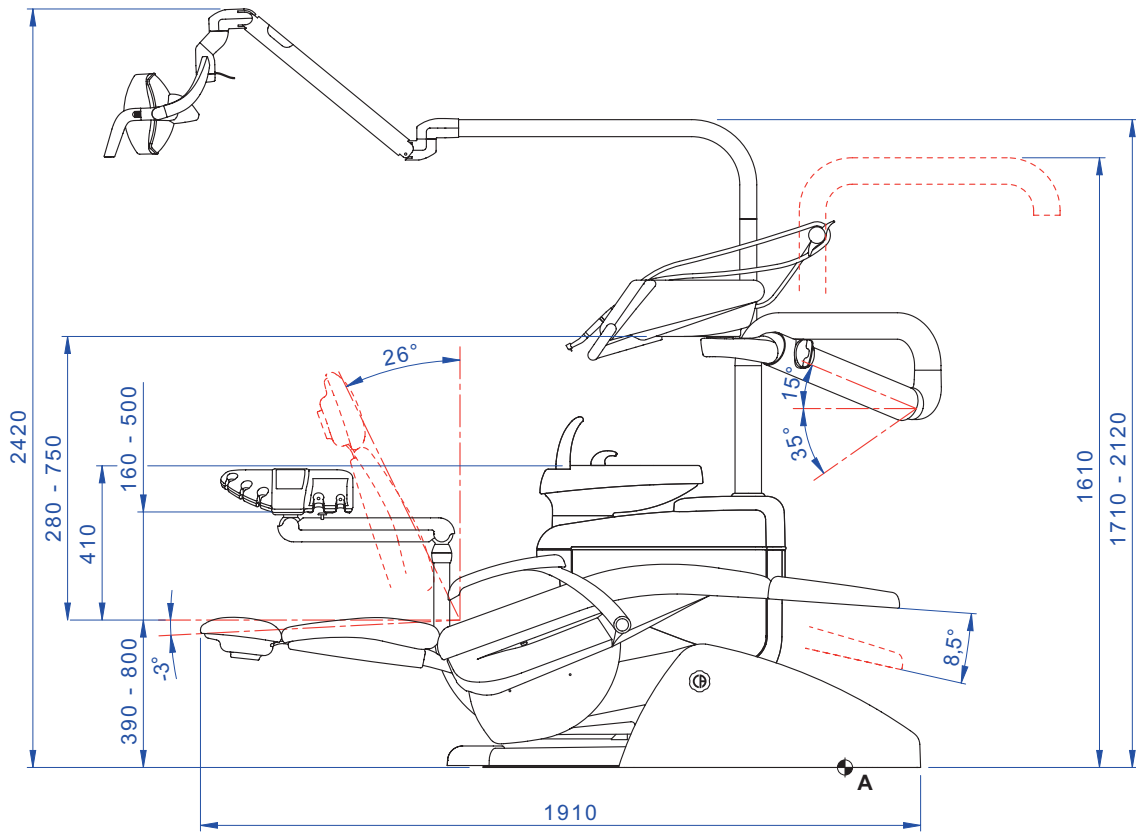



11.3. Overall dimensions SKEMA 8 RS

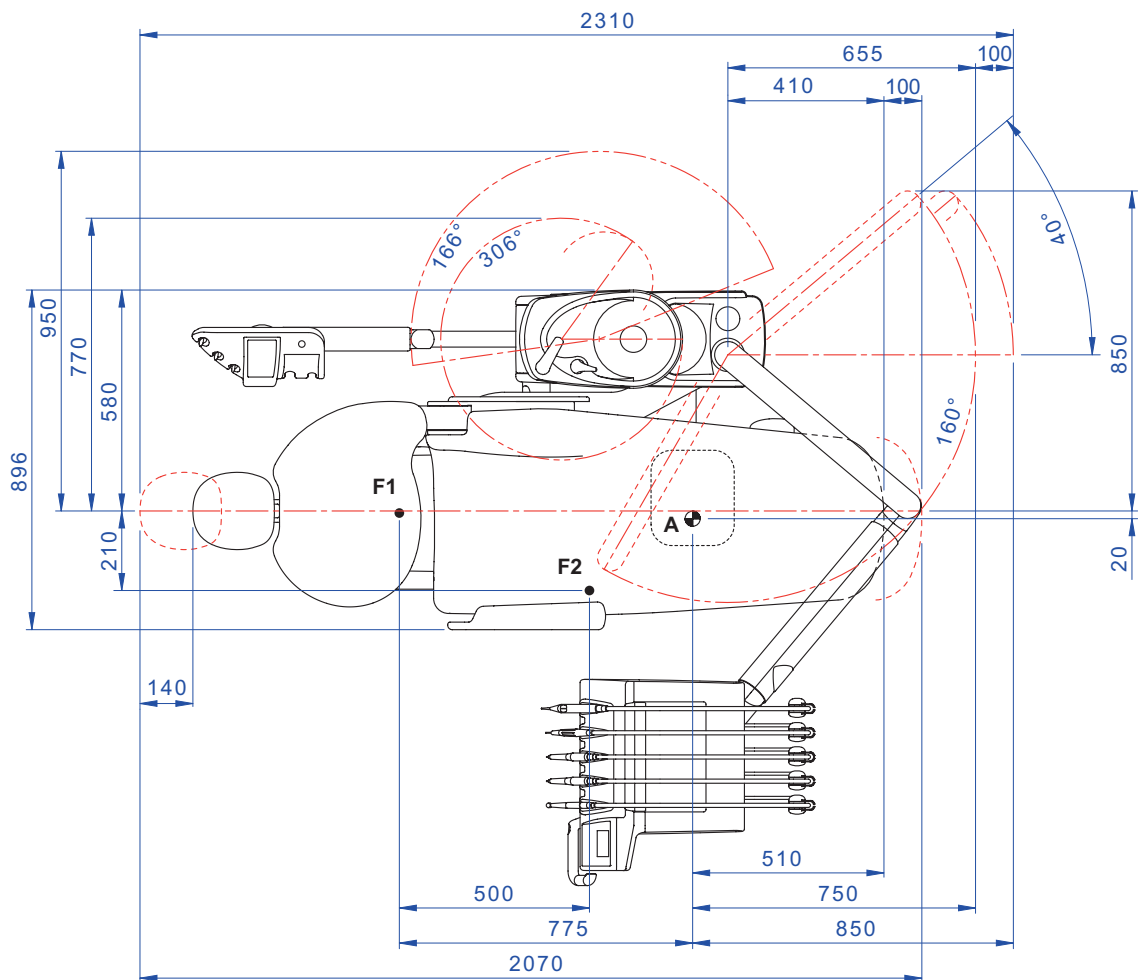
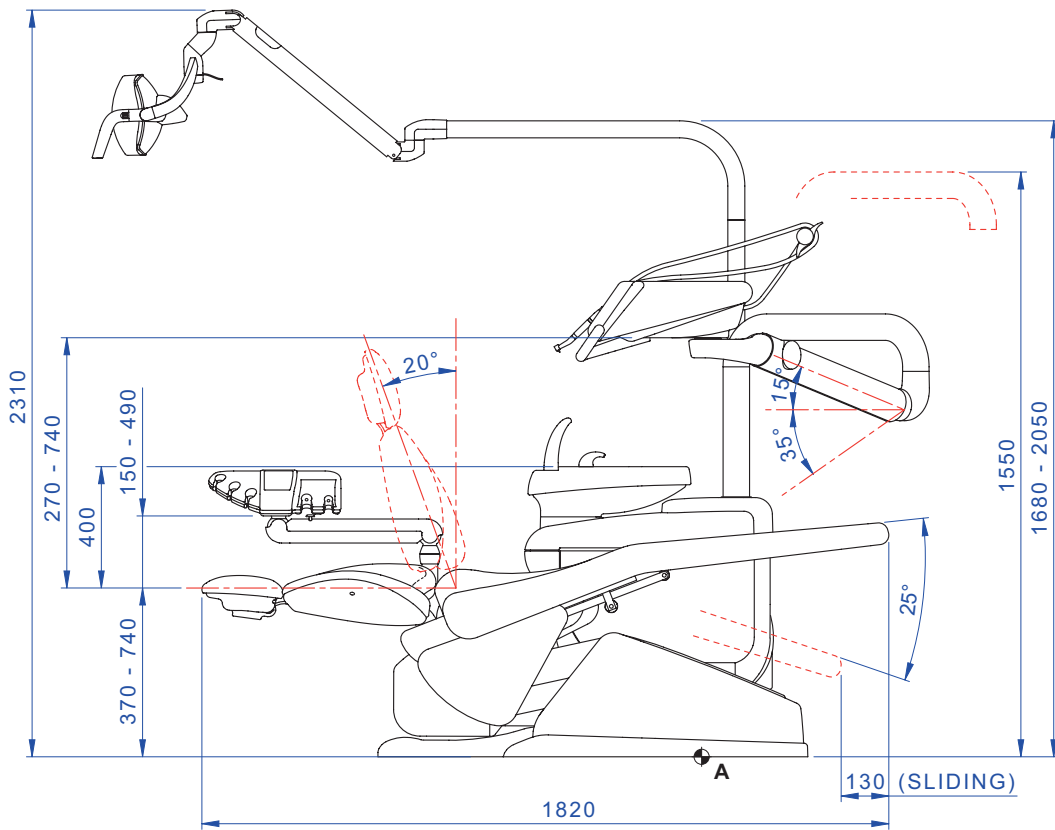



12. Dental operatory maintenance plan

WHEN	PART	WHAT TO DO	SEE PARAGRAPH
Before starting work	Condensate drain cock	Drain condensate from air ducts.	See paragraph 9.2.
	Spray ducts (if the dental unit is turned off for more than 48 hours)	Disinfect water ducts of sprays with manual cycle (if the S.S.S. system is present).	See paragraph 7.2.1.
		Disinfect water ducts of sprays with semi-automatic cycle (if the AUTOSTERIL system is present).	See paragraph 7.2.
	CATTANI surgical separator	Insert a tablet into each suction filter of VF CONTROL PLUS.	See paragraph 9.5.
	Single-use protective barriers	Put single-use barriers and flexible protection on dental chair and dental unit.	/
	Strumenti	Lubricate micromotor and turbine handpieces.	See documentation enclosed with the instrument.
After each treatment	Spray ducts	Flush water ducts of sprays (if the TIME FLUSHING system is present).	See paragraph 7.5.
	Instruments	Sterilize or disinfect the exterior.	See documentation enclosed with handpiece.
	Camera	Disinfect the exterior.	See paragraph 5.8.
	Curing lamp	Disinfect the exterior.	See paragraph 5.7.
	Surgical suction tubes	Run an automatic flushing cycle (if present) or aspirate about ½ litre of STER 3 PLUS diluted in a 6% solution with each of the cannulas used.	See paragraph 9.4.
	Flexible protection	Sterilize the contaminated flexible protection.	/
	Single-use barriers	Replace the single-use barriers.	/
	Contaminated surfaces	Disinfect with STER 1 PLUS .	/
At the end of the work day	Spray ducts	Disinfect water ducts of sprays with manual cycle (if the S.S.S. system is present).	See paragraph 7.2.1.
		Disinfect water ducts of sprays with semi-automatic cycle (if the AUTOSTERIL system is present).	See paragraph 7.2.
	Bowl filter	Clean the filter in running water. The content must be disposed separately.	See paragraph 7.1.
	Bowl	Clean with commercial detergents designed for ceramic materials. Do not use harsh products or acids.	See paragraph 7.1.
	Surgical suction filter	Check the filter and replace it if the suction capacity is reduced (code 97461845).	See paragraph 9.3.
	Surgical suction tubes	Run an automatic flushing cycle (if present) or aspirate about ½ litre of STER 3 PLUS diluted in a 6% solution with each of the cannulas used.	See paragraph 9.4.
	Hydraulic saliva ejector	Clean the saliva ejector filter.	See paragraph 6.4.
	Flexible protection	Sterilize the flexible protection present.	/
	Single-use barriers	Remove the single-use barriers used.	/
	Dental chair and dental unit surfaces	Clean surfaces with STER 1 PLUS .	/



When needed.	Removable instrument cords	Clean with a suitable disinfectant carefully following the directions for use provided by the manufacturer. Spray the product on soft disposable paper towels. Do not use acids or harsh products.	See paragraph 5.
	Spray ducts	Disinfect water ducts of sprays with manual cycle (if the S.S.S. system is present).	See paragraph 7.2.1.
		Disinfect water ducts of sprays with semi-automatic cycle (if the AUTOSTERIL system is present).	See paragraph 7.2.
	CATTANI surgical separator	Clean the separator's container, drain valve and probes.	See paragraph 9.5.
	METASYS amalgam separator	Empty the separator bowl.	See documentation enclosed with the separator.
	DURR amalgam separator	Empty the separator bowl.	See documentation enclosed with the separator.
	Operatory light	Clean the front glass and reflector mirror.	See documentation enclosed with the equipment.
	VENUS PLUS-L LED operating lamp	Clean the transparent screen and the handles.	See paragraph 8.1.1.
	Monitor with light pole	Clean the surfaces.	See documentation enclosed with the equipment.
	Coated surfaces and dental chair upholstery	Clean with a suitable disinfectant carefully following the directions for use provided by the manufacturer. Spray the product on soft disposable paper towels. Do not use acids or harsh products.	See paragraph 1.4.
Weekly.	Suction tube holders	Lubricate the o-rings.	See paragraph 9.6.
Monthly.	Turbine return air filter	Check the filter and replace it if necessary (code 97290014).	See paragraph 9.6.
	H.P.A. filter	Sterilize the filter cartridge.	See paragraph 8.5.
Yearly.	Dental chair and dental unit	Contact the technical service department for general inspection.	/

CEFLA s.c.

Via Selice Prov.le 23/a – 40026 Imola (BO) Italy
 P. Iva/Vat It 00499791200 – C.F. 00293150371
 Reg. Imprese n. 5089/BO – R.E.A. n.36186/BO
 www.cefla.it – ceflaimola@cefla.it

Stabilimento / Plant

Via Bicocca 14/c – 40026 Imola (BO) Italy
 Tel. (+39) 0542 653441 – Fax (+39) 0542 653555
 www.cefladentale.it - cefladentale@cefla.it

**DICHIARAZIONE DI CONFORMITÀ “CE / EU” / “CE / EU” CONFORMITY DECLARATION
 DECLARATION DE CONFORMITÉ “CE / EU” / ERKLÄRUNG VON “CE / EU” ZUSTIMMUNG / DECLARACION DE CONFORMIDAD “CE / EU”
 DECLARAÇÃO DE CONFORMIDADE “CE / EU” / ΔΗΛΩΣΗ ΠΙΣΤΟΤΗΤΑΣ “CE / EU” / ДЕКЛАРАЦИЯ СООТВЕТСТВИЯ “CE / EU”
 DEKLARACJA ZGODNOSCI WE “CE / EU” / “CE / EU” UYGUNLUK BELGESİ**

Prodotto tipo/ Product type :

<p>Incollare in questo spazio l'etichetta del complesso odontoiatrico o di altra apparecchiatura o indicare modello e numero di matricola Stick the label of the dental equipment or other device into this space or write model and serial number</p>
<input type="text"/>
<input type="text"/>

Matr./ Serial N°:

- I** Dichiaro sotto la nostra esclusiva responsabilità che i prodotti ai quali questa dichiarazione si riferisce sono conformi
 1) ai requisiti essenziali (Allegato I) presenti nella direttiva 93/42/CEE Dispositivi Medici (D.Lgs.46/97) e successive modifiche ed integrazioni (**dispositivo medico di Classe IIa**)
 2) alla direttiva 2011/65/UE del Parlamento europeo e del Consiglio dell'8 giugno 2011, sulla restrizione dell'uso di determinate sostanze pericolose nelle apparecchiature elettriche ed elettroniche (Rohs 2)
- GB** We declare, on our sole responsibility, that the products referred to herein are in compliance with
 1) the essential requirements (Annexe I) of Directive 93/42/EEC Medical devices (Leg. Decree 46/97) and subsequent amendments and integrations (**Class IIa medical device**)
 2) Directive 2011/65/EU of the European Parliament and of the Council of 8 June 2011 on the restriction of the use of certain hazardous substances in electrical and electronic equipment (Rohs 2)
- F** Nous déclarons, sous notre complète responsabilité, que les produits auxquels la présente déclaration fait référence sont conformes
 1) aux exigences essentielles (Annexe I) présentes dans la directive 93/42/CEE "Dispositifs médicaux" (Décr.L. 46/97) et modifications successives et intégrations (**dispositif médical de Classe IIa**)
 2) à la directive 2011/65/UE du Parlement européen et du Conseil du 8 juin 2011 relative à la limitation de l'utilisation de certaines substances dangereuses dans les équipements électriques et électroniques (Rohs 2)
- D** Wir erklären hiermit in alleiniger Verantwortung, dass die Produkte, auf die sich diese Erklärung bezieht, konform sind mit
 1) den grundlegenden Anforderungen (Anhang I) der Richtlinie 93/42/EWG über Medizinprodukte (Gesetzesverordnung 46/97) und nachfolgenden Änderungen und Ergänzungen (**medizinisches Gerät der Klasse IIa**)
 2) der Richtlinie 2011/65/EU des Europäischen Parlaments und des Rats vom 8. Juni 2011 zur Beschränkung der Verwendung bestimmter gefährlicher Stoffe in Elektro- und Elektronikgeräten (Rohs 2)
- E** Declaramos bajo nuestra exclusiva responsabilidad que los productos a los que esta declaración se refiere, están conformes con
 1) los requisitos esenciales (Anexo I) presentes en la directiva 93/42/CEE Dispositivos Médicos (D. Leg. 46/97) y sucesivas modificaciones e integraciones (**dispositivo médico de Clase IIa**)
 2) la directiva 2011/65/UE del Parlamento europeo y del Consejo del día 8 de junio de 2011, sobre la restricción del uso de determinadas sustancias peligrosas en los aparatos eléctricos y electrónicos (Rohs 2)
- P** Declaramos sob a nossa exclusiva responsabilidade que os produtos aos quais esta declaração se refere estão em conformidade
 1) com os requisitos essenciais (Anexo I) presentes na diretiva 93/42/CEE Dispositivos Médicos (em Itália, transposta pelo Decreto Legislativo 46/97) e posteriores alterações e aditamentos (**dispositivo médico de Classe IIa**)
 2) com a diretiva 2011/65/UE do Parlamento europeu e do Conselho de 8 de junho de 2011, relativa à restrição do uso de determinadas substâncias perigosas em equipamentos elétricos e eletrónicos (Rohs 2)
- GR** Δηλώνουμε με την αποκλειστική ευθύνη μας ότι τα προϊόντα στα οποία αναφέρεται η παρούσα δήλωση είναι σύμφωνα
 1) με τις βασικές απαιτήσεις (Προάρτημα I) της οδηγίας 93/42/ΕΟΚ Ιατροτεχνολογικών Προϊόντων (Ν. Διάτ.46/97) και μεταγενέστερες τροποποιήσεις και συμπληρώσεις (**ιατροτεχνολογικό προϊόν Κατηγορίας IIa**)
 2) με την οδηγία 2011/65/ΕΕ του Ευρωπαϊκού Συμβουλίου και του Συμβουλίου της 8 Ιουνίου 2011, για τον περιορισμό της χρήσης ορισμένων επικίνδυνων ουσιών σε ηλεκτρικό και ηλεκτρονικό εξοπλισμό (Rohs 2)
- PY** Под нашу исключительную ответственность заявляем, что изделия, к которым относится данная декларация, соответствуют
 1) основным требованиям (Приложение I) директивы 93/42/ЕЭС Медицинские устройства (Законодательный указ № 46/97) и последующим изменениям и дополнениям (**медицинское устройство Класса IIa**)
 2) директиве 2011/65/ЕС Европарламента и Совета Европы от 8 июня 2011 года по ограничению использования определенных опасных веществ в электрическом и электронном оборудовании (Rohs 2)
- PL** Oświadczamy na swoją wyłączną odpowiedzialność, że produkty objęte niniejszym oświadczeniem są zgodne:
 1) z zasadniczymi wymaganiami (Załącznik I) przewidzianymi dyrektywą 93/42/EWG Wyroby Medyczne (D. z mocą ustawy 46/97) wraz z późniejszymi zmianami i uzupełnieniami (**wyrób medyczny Klasa IIa**)
 2) z dyrektywą 2011/65/WE Parlamentu europejskiego i Rady z dnia 8 czerwca 2011r. w sprawie ograniczeń we wprowadzaniu do obrotu i stosowaniu w sprzęcie elektrycznym i elektronicznym określonych niebezpiecznych substancji (Rohs 2)
- TR** Bu beyannamede bahsi geçen ürünlerin aşağıda belirtilenlere uygun olduğunu kendi mühasır sorumluluğumuz altında beyan ederiz:
 1) (Kanun hükmünde Kararname 46/97) Medikal Aygıtlar 93/42/CEE direktifinde mevcut (Ek 1) ana gereklilikler ve sonraki değişiklikler ve eklemelerde belirtilenler (**IIa sınıf medikal aygıt**)
 2) 8 Haziran 2011 tarihli Avrupa Parlamentosu ve Konseyi'nin "Elektrikli ve elektronik cihazlarda bazı tehlikeli maddelerin kullanılmasına ilişkin kısıtlamalar" 2011/65/UE direktifi (Rohs 2)

Imola, li _____

**Bussolari Paolo
 Managing Director**

