

97050901

REF. 97050900

Rev. 01 - 18.01



RX DC



CEFLA s.c. VIA SELICE PROV.LE 23/A - 40026 IMOLA (BO) ITALY
PLANT: VIA BICOCCA 14/C - 40026 IMOLA (BO) ITALY

EN

Contents

1. GENERAL WARNINGS.....	5
1.1. SYMBOLS	5
1.2. STANDARDS AND REGULATIONS	6
1.3. INTENDED USE	6
1.4. CLASSIFICATION	6
1.5. ENVIRONMENTAL CONDITIONS	7
1.6. WARRANTY	7
1.7. PROTECTION AGAINST RADIATION	8
2. DESCRIPTION OF THE X-RAY DEVICE	9
2.1. INSTALLATION TYPE	9
2.2. TYPE OF X-RAY HEAD	13
2.3. HANDHELD	14
3. SWITCHING ON AND OFF THE X-RAY DEVICE	15
4. HANDHELD FUNCTIONS	16
4.1. HANDHELD DISPLAY FUNCTIONS	17
4.2. USE OF HANDHELD	18
4.3. CHECKING THE PARAMETERS	19
4.4. FACTORY SETTINGS	20
5. USE OF THE X-RAY DEVICE	21
5.1. PATIENT POSITIONING	21
5.2. POSITIONING THE X-RAY HEAD	21
5.3. POSITION OF THE X-RAY PLATE OR SENSOR	22
5.4. SETTING THE EXPOSURE MODE AND TIME	23
5.5. PROCEDURE TO BE FOLLOWED WHEN TAKING THE X-RAY	25
6. ADVANCED OPTIONS	26
6.1. SETTING THE OPERATING MODE	27
6.2. SETTING TYPE OF MOVABLE COLLIMATOR	28
6.3. RESTORING FACTORY SETTINGS	28
7. ERROR MESSAGES	29
8. PERIODIC MAINTENANCE	30
9. CLEANING AND DISINFECTION	31
10. DISPOSING THE EQUIPMENT WHEN NO LONGER USED	32
11. TECHNICAL DATA	33
11.1. X-RAY TUBES	35
11.2. TECHNICAL FACTOR MEASURE	36
12. DIMENSIONAL CHARACTERISTICS	37
13. IDENTIFICATION PLATES	44
14. TIMES/SENSITIVITY CHARTS	46
15. NOMINAL DOSE EMISSION VALUES	47
16. INSPECTION AND MAINTENANCE	57
16.1. USER INSPECTION	57
16.2. TECHNICAL MAINTENANCE	58

1. GENERAL WARNINGS

These instructions explain how to correctly use the RX DC x-ray unit. Please carefully read this manual before using the device.

 **NOTE: This manual does not specify all the obligations and warnings for possessing a source of ionising radiation as each country has its own laws. Only the most common ones shall be mentioned and this means that it is the user's responsibility to check local standards and observe the relevant laws.**













This publication must not be reproduced, copied or transferred in any manner (electronically, mechanically, via photocopies, translations or other means) without the prior written consent of the manufacturer.



The manufacturer has a company policy of continual development. Therefore, some of the instructions, specifications and figures given in this manual may slightly differ from the purchased product. The manufacturer reserves the right to make changes to this manual without giving prior notice.

The original text is in Italian.

Please consult the Web site of the manufacturer to find a list of authorised representatives.

1.1. SYMBOLS

	Type of protection against direct and indirect contact: Class I. Level of protection against direct and indirect contact: TYPE B.
	WARNING! Failure to observe may result in equipment damage or injury to the user and/or patient.
	NOTE: Indicates information that is especially important for the user and/or assistant.
	Protective ground contact.
	Alternating current.
	On.
	Off.
	Ionising radiations.
	Equipment in compliance with essential requirements of directive 93/42/EEC and subsequent changes.
	Disposal symbol in accordance with Directives 2002/95/EC and 2003/108/ EC.
FCC ID	F.C.C. mark (Federal Communication Commission).
	Operating instructions. Consult the enclosed documentation before using the device.
	It is necessary to refer to the user manual.

	Pushing prohibited.
	Stepping prohibited.
 UA.TR.101	Ukrainian national symbol of conformity.

1.2. STANDARDS AND REGULATIONS

The system has been designed to meet the following standards:

- Directive 93/42/EEC and s.c. (dir. 2007/47/EC) - Medical Device Directive;

Technical Standards:

- IEC 60601-1:2005
- IEC 60601-1-2:2007
- IEC 60601-1-3:2008
- IEC 60601-2-65:2012
- IEC 60601-1-6:2010
- IEC 62366:2008

The CE marking certifies compliance of the product as described by Medical Device Directive 93/42/EEC and subsequent amendments.

1.3. INTENDED USE

This x-ray unit is designed for use in the dental surgery to make endo-oral x-rays for diagnostic purposes.

This equipment can be used to produce traditional x-rays developed using chemicals or, alternatively, it can be used with digital x-ray sensors.

1.4. CLASSIFICATION

- **MEDICAL DEVICE classification.**
Classification of the equipment according to the rules indicated in Annex IX of **Directive 93/42/EEC and subsequent changes: CLASS IIB.**
- **ELECTRO-MEDICAL EQUIPMENT classification.**
Equipment classification in accordance with standard **I.E.C. 60601-1** for safety of medical equipment: **CLASS I TYPE B, not continuous use.**
- **RADIO EQUIPMENT AND TELECOMMUNICATIONS TERMINAL EQUIPMENT classification.**
Equipment classification according to Directive **99/05/EC Art.12: CLASS I.**
- **EMC classification.**
Equipment classification in accordance with standard **CEI EN 55011: GROUP I TYPE B.**

1.5. ENVIRONMENTAL CONDITIONS

The equipment is to be installed in rooms that satisfy the following requirements:

- Temperature from +10 to +40° C.
- Relative humidity from 25 to 75% without condensate.
- Atmospheric pressure from 700 to 1060 hPa.

The electrical wiring in the room in which the equipment is installed must conform to I.E.C. 60364-7-710;V2 specification (i.e. the regulations concerning the electrical wiring to be used in surgeries) or equivalent standards in force in the country where the equipment is installed.

- **ELECTRICAL CONNECTIONS:** the electrical system must be provided with an adequate grounding system that complies with regulations I.E.C. - US National Electrical Code and C.E.I.. In Italy, it must be executed in accordance with IEC 60364-7-710, which requires a differential-thermal breaker with the following characteristics upstream of the system:
 - contact capacity: 250V 10° or 120V 16A in compliance with standards IEC 60898-1 and IEC 60947-2;
 - differential sensitivity: 0.03A;
 - power supply: 3x2.5 mm².

The colour of the 3 wires should be as specified in the standards (BROWN power, BLUE neutral, YELLOW/GREEN ground).

1.6. WARRANTY

The manufacturer stands behind its products warranting safety, reliability and performance. The warranty is valid only under the following terms:

- Closely observe the conditions specified in the warranty certificate itself.
- The equipment is only to be used as instructed in this manual.
- Equipment installation, expansion and technical support must be performed exclusively by personnel authorised by the manufacturer to carry out these operations.
- Never open the equipment casing. Installation, repairs and, in general, any other operations requiring the casing to be opened are to be performed exclusively by personnel authorised by the manufacturer to carry out these operations.
- The equipment is to be installed in rooms that follow the requirements specified in paragraph 1.2.2. "Environmental conditions".
- The room where the x-ray unit is installed must comply with official regulations regarding protection against radiation in the country where the equipment is used.

SAFETY WARNINGS.

- If any person who is not an authorised technician changes the product in any way by replacing parts or components with other ones not used by the manufacturer, they shall assume responsibility for the product.
- Do not forget to turn off the main switch on the equipment before leaving the surgery.
- The equipment is not protected against liquid penetration (risk of electrocution).
- The equipment is not suitable for use in the presence of a mixture of flammable anaesthetic gas with oxygen or nitrous oxide.
- This equipment must be stored properly so that it is kept in top working order at all times.
- Use of electric scalpels or other electric apparatus that do not comply with standard I.E.C. 60601-1-2, in the surgery or nearby may cause electromagnetic or other types of interferences resulting in equipment malfunctions. In these cases shut off the power supply to the equipment beforehand.
- The manufacturer shall not be held responsible for misuse, carelessness or improper use of the equipment.
- The equipment may only be used by authorised and adequately trained staff (dentists and paramedics).
- The user must be present at all times when the equipment is turned on or ready for start-up. In particular, never leave the equipment unattended in the presence of children/the mentally disabled or other unauthorised personnel in general.
- If the x-ray equipment is damaged or oil leaks, do not use the equipment and contact customer service immediately.



1.7. PROTECTION AGAINST RADIATION

PROTECTION AGAINST RADIATIONS.

X-rays are hazardous and adequate precautions must be taken when using them. Areas where it is possible to be exposed to x-rays shall be clearly indicated by using this symbol, which should remind personnel to observe the safety rules laid down by the laws in force in the country where the equipment is used.



- Control the emission of x-rays from the greatest distance possible (at least 2 meters) from the focal spot and the x-ray irradiation beam in the opposite direction to where the rays are emitted. For installations in Canada, the required distance is 3 meters.
 - Only the authorised personnel and the patient can remain in the room when x-rays are being emitted.
 - The device is provided with an interlock input. If the interlock is activated, it means that the door is open while the examination is in progress and the ray emission is inhibited. To proceed with the examination, close the door.
 - Make sure that the operator can communicate verbally and visually with the patient during the examination.
 - As for the installation, please refer to the Technical Manual.
 - Always protect the patient's thyroid and gonads under all circumstances.
 - **Whenever the patient is a child or disabled person requiring the presence of the dentist to keep the image receiver in position, it is advisable to use a positioner, following the instructions of the manufacturer of the receiver, and a special glove to protect the hand against x-rays. Use a suitable overall to protect the rest of the body against exposure to x-rays.**
-

2. DESCRIPTION OF THE X-RAY DEVICE

The x-ray unit is available in several versions, which differ in type of installation, x-ray head and handheld. It is possible to identify the different versions via the REF on the nameplate.

2.1. INSTALLATION TYPE WALL-MOUNTED VERSION

 **NOTE:** This section applies only to models RX DC REF: MRPU****S, MRXU****S
(Character * can be any alphanumeric value)

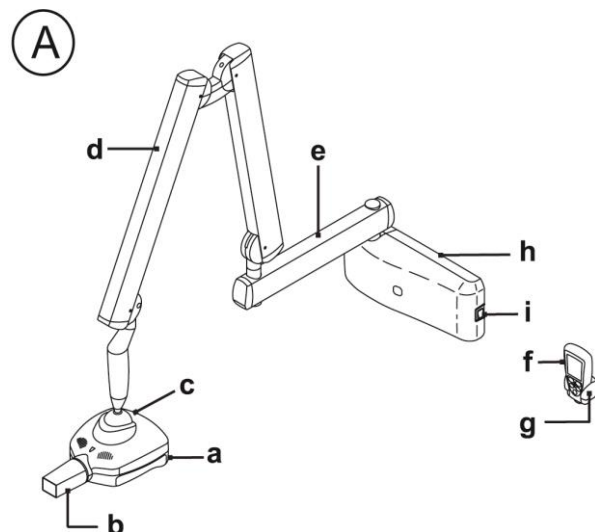

a. X-ray generator.

Constant potential high frequency x-ray generator.

b. Removable collimator (cone).

The generator can work with different types of collimator that are automatically recognised:

- 8" cylindrical COLLIMATOR (incorporated in the generator): minimum skin/focus distance 20cm and 60mm output beam.
- removable 12" rectangular COLLIMATOR (only for MRPU****S): minimum skin/focus distance 30cm and 45x35 mm output beam (rectangular collimator attached).
- removable 12" round COLLIMATOR (standard for MRXU****S, optional for MRPU****S): minimum source/skin distance 30cm and diameter of collimator output beam 55mm (with collimator attached).

The following rectangular collimators to be attached to a 12" round collimator are also available as optionals:

- rectangular COLLIMATOR 22x35 mm
- rectangular COLLIMATOR 31x41 mm.

c. Focus spot.

d. Double pantograph arm.

e. Extension arm.

The extension arm is available in three length versions: 40 cm (15.7"), 60 cm (23.6") and 90 cm (35.4").

f. Handheld.

The handheld can be placed either near the control unit or in a remote position. As a result, the doctor can move conveniently around the room and move out of the area where x-rays are emitted.

g. Handheld holder.

h. Control unit.

i - Main switch.

INSTALLATION INTEGRATED IN DENTAL UNIT



NOTE: This section applies only to models RX DC REF: MRPU****I
(Character * can be any alphanumeric value)

B

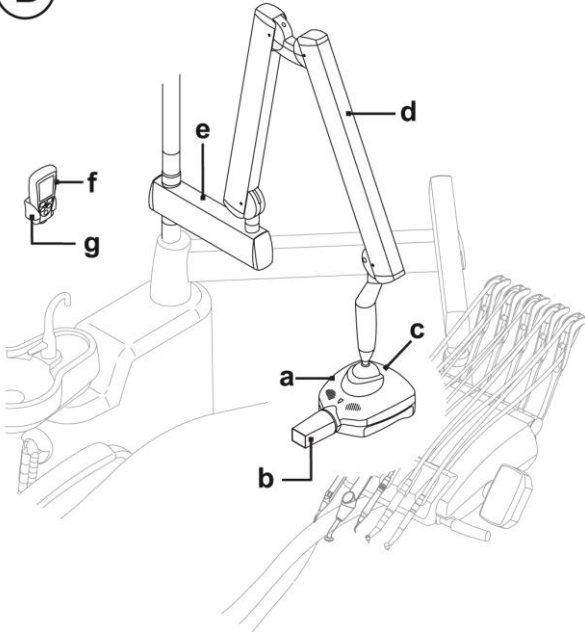

c. X-ray generator.

Constant potential high frequency x-ray generator.

d. Removable collimator (cone).

The generator can work with different types of collimator that are automatically recognised:

- 8" cylindrical COLLIMATOR (incorporated in the generator): minimum skin/focus distance 20cm and 60mm output beam.
- removable 12" rectangular COLLIMATOR (only for MRPU****I): minimum skin/focus distance 30cm and 45x35 mm output beam (rectangular collimator attached).
- removable 12" round COLLIMATOR (optional for MRPU****I): minimum source/skin distance 30cm and diameter of collimator output beam 55mm (with collimator attached).

The following rectangular collimators to be attached to a 12" round collimator are also available as optionals:

- rectangular COLLIMATOR 22x35 mm
- rectangular COLLIMATOR 31x41 mm.

c. Focus spot.

d. Double pantograph arm.

e. Extension arm.

The only size of the extension arm is 30 cm (11.8").

f. Handheld.

The handheld can be placed either near the control unit or in a remote position. As a result, the doctor can move conveniently around the room and move out of the area where x-rays are emitted.

g. Handheld holder.

h. Control unit.

i - Main switch.



NOTE: when integrating the x-ray unit in the dental unit, the exact position of (h) and (i) depends on the specific mechanical configuration. However, the integration must be appropriate and in line with the requirements of IEC60601-1. For installation instructions and details, refer to the technical manual.

MOBILE STAND INSTALLATION



NOTE: This section applies only to models RX DC REF: MRXU****M
(Character * can be any alphanumeric value)

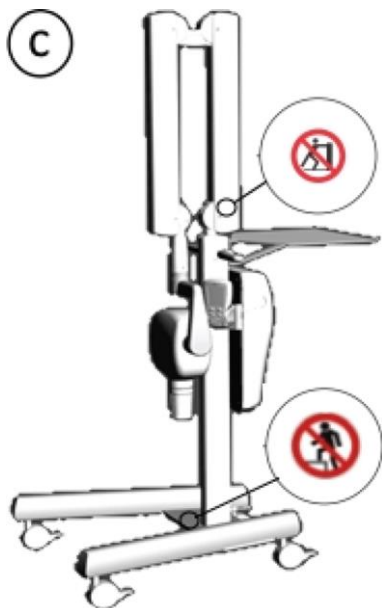

e. X-ray generator.

Constant potential high frequency x-ray generator.

f. Removable collimator (cone).

The generator can work with different types of collimator that are automatically recognised:

- 8" cylindrical COLLIMATOR (incorporated in the generator): minimum skin/focus distance 20cm and 60mm output beam.
- REMOVABLE 12" rectangular COLLIMATOR (only for MRXU****M): minimum skin/focus distance 30cm and 45x35 mm output beam (rectangular collimator attached).
- REMOVABLE 12" ROUND COLLIMATOR (optional for MRXU****M): minimum source/skin distance 30cm and diameter of collimator output beam 55mm (with collimator attached).

The following rectangular collimators to be attached to a 12" round collimator are also available as optionals:

- RECTANGULAR COLLIMATOR 22x35 mm
- RECTANGULAR COLLIMATOR 31x41 mm.

c. Focus spot.

d. Double pantograph arm.

e. Handheld.

The handheld can be placed either near the control unit or in a remote position. As a result, the doctor can move conveniently around the room and move out of the area where x-rays are emitted.

f. Handheld holder.

g. Control unit.

h. Main switch.



WARNING!

Never move the mobile stand x-ray unit without first securing the support arm with the special strap.

To move the mobile stand x-ray unit:

- 1) Unplug the x-ray unit power cord from the power supply.
- 2) Place the power cord so that it does not get in the way.
- 3) Always secure the support arm with the associated safety belt.
- 4) Move the x-ray unit carefully using the handles.

WARNING!

Moving the mobile stand x-ray unit without using the handles can cause the device to fall, unbalance or tip over. Be very careful and always use the handles.

WARNING!



During the movement of the mobile stand, pay attention to the presence of steps and / or horizontal obstacles as they may cause a situation of instability and / or tip over the cart. If you wish to move the x-ray over a small obstacle, gently tilt the base by pressing with your foot near the rear wheels.

WARNING!

The tray can hold a maximum of 5kg.

WARNING!

Do not step on the mobile stand or parts of it.

To stop the mobile stand in the desired position, lock the wheel brakes by pressing the lever down. Upwards to unlock.



NOTE: always lock at least two brakes to avoid unwanted movements.

2.2. TYPE OF X-RAY HEAD

X-RAY HEAD WITH BALL JOINT

 **NOTE:** This section applies only to models RX DC REF: MRPU*****
(Character * can be any alphanumeric value)

The mechanical fitting with which the x-ray head is connected to the pantograph arm is a ball joint. The ball is provided with a mechanical brake to allow the x-ray head to maintain the position set by the operator. The generator can freely rotate on the horizontal plane. On the vertical plane, the upward rotation is limited by a mechanical end stop.



The cone, indicated with *, is the only applied part

X-RAY GENERATOR INDICATOR LIGHT FOR X-RAY UNIT WITH BALL JOINT:

	<p>The x-ray generator is provided with an indicator light (B) that signals the unit status.</p> <p>Key to colours:</p> <table><tr><td>- violet</td><td>> x-ray unit on (regular condition)</td></tr><tr><td>- flashing violet</td><td>> stand-by (low consumption)</td></tr><tr><td>- blue</td><td>> x-ray unit on – head locked</td></tr><tr><td>- yellow</td><td>> x-ray being emitted</td></tr><tr><td>- red</td><td>> fault</td></tr></table>	- violet	> x-ray unit on (regular condition)	- flashing violet	> stand-by (low consumption)	- blue	> x-ray unit on – head locked	- yellow	> x-ray being emitted	- red	> fault
- violet	> x-ray unit on (regular condition)										
- flashing violet	> stand-by (low consumption)										
- blue	> x-ray unit on – head locked										
- yellow	> x-ray being emitted										
- red	> fault										

X-RAY HEAD WITH ARCH

 **NOTE:** This section applies only to models RX DC REF: MRXU*****
(Character * can be any alphanumeric value)

The mechanical fitting with which the x-ray head is connected to the pantograph arm is an arch. The arch allows the x-ray head to maintain the position set by the operator.

The generator is can freely rotate both on the horizontal and vertical plane. The rotation is limited by suitable mechanical stops.



The cone, indicated with *, is the only applied part

2.3. HANDHELD

The handheld is turned on by pressing any key, except for the one for x-ray emission.

WIRELESS HANDHELD



NOTE: This section applies only to models RX DC REF: MRPU*W*, MRXU***W*
(Character * can be any alphanumeric value)**

This handheld uses a wireless connection to communicate with the x-ray unit.

The wireless communication complies with specifications IEEE 802.11 b/g/n. The connection is protected through cryptography and no other wireless product, except for the handheld, can connect to the unit.

Handheld batteries:

- Type: 2 x AA - Alkaline 1.5V.

WIRED HANDHELD



NOTE: This section applies only to models RX DC REF: MRPU*C*, MRXU***C*
(Character * can be any alphanumeric value)**

This handheld uses a cable connection to communicate with the x-ray unit.

3. SWITCHING ON AND OFF THE X-RAY DEVICE

TURNING ON THE WALL-MOUNTED X-RAY UNIT

 **NOTE:** This section applies only to models RX DC REF: MRPU****S, MRXU****S
(Character * can be any alphanumeric value)

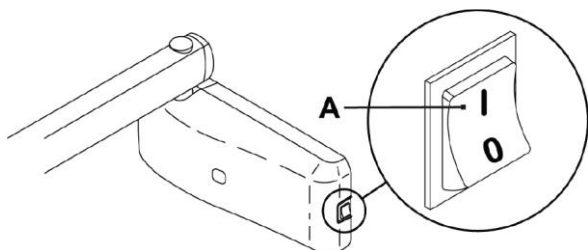

The control unit is turned on and off from the main switch (A).
The switch lights up to indicate that the control unit is powered.

TURNING ON THE X-RAY UNIT INTEGRATED IN THE DENTAL UNIT

 **NOTE:** This section applies only to models RX DC REF: MRPU****I
(Character * can be any alphanumeric value)

The ON/OFF switch position depends on the type of integration in the dental unit. For this reason, please refer to the user manual of the relevant dental units.

The control unit is automatically turned on and off using the main switch of the dental unit.
However, the x-ray unit has its own power supply line with wall-mounted switch (not provided) to shut off power separately from the dental unit.
Make sure that the switch has been turned on when the device needs to be used.

TURNING ON THE MOBILE STAND X-RAY UNIT

 **NOTE:** This section applies only to models RX DC REF: MRXU****M
(Character * can be any alphanumeric value)

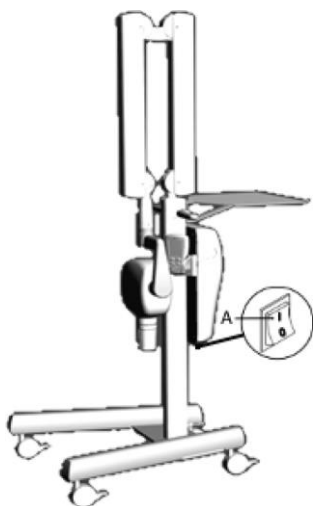

The control unit is turned on and off from the main switch (A).
The switch lights up to indicate that the control unit is powered.

NOTE: The technical specifications of the switch are outlined in paragraph 1.5.
Whenever turned on, the equipment performs an operational test that takes a few seconds. A beep is emitted at the end of the test.

 **NOTE:** The exposure time and the parameters displayed on the handheld when the unit is turned on are the last ones set before the control unit was turned off.
If the control unit is left untouched for a few minutes, it will go into standby mode. Simply press any key on the control panel to reactivate it.

4. HANDHELD FUNCTIONS

The handheld is turned on by pressing any key, except for the one for x-ray emission.

A buzzer rings to confirm that the unit has been turned on. The unit will be in the standard configuration and it will start searching for the base it works with.

If the base is off, the handheld will not indicate the field or the status "ready". If the base is later turned on, the handheld will detect it within thirty seconds or by pressing any function key on the push-button panel.



NOTE: To optimise the range of the handheld while it is being used, keep it away from walls and metal instruments and, above all, do not cover its built-in antenna on top of the screen. In addition, performance may be reduced if the handheld is moved too quickly while x-rays are being taken. Error E 31 may be displayed if out of range problems occur.

WIRELESS HANDHELD



NOTE: This section applies only to models RX DC REF: MRPU***W*, MRXU***W*
(Character * can be any alphanumeric value)

AUTOMATIC HANDHELD SHUT OFF:

Once the control unit has been turned off, the handheld automatically shuts off after approximately one minute.

The handheld also automatically shuts off when it is at a further distance from the maximum range of the control until.

HANDHELD TIMED STAND-BY:

The entire x-ray unit will switch over to stand-by (even if the base is on) and the handheld will automatically shut off after approximately five minutes of non-use to save battery power.

BATTERIES AND CHARGE LEVEL INDICATION:

The handheld runs on two standard AA alkaline batteries to assure sufficient stand-alone operation.

The charge level of the batteries is shown on the screen as follows:



Battery fully charged (no symbol appears in the area that shows the battery charge level).



Battery half-charged.



Battery charge level low or almost dead (causing the handheld to automatically shut off).



NOTE: The batteries should be removed from the handheld if it is not going to be used for an extended period.

WIRED HANDHELD



NOTE: This section applies only to models RX DC REF: MRPU***C*, MRXU***C*
(Character * can be any alphanumeric value)

AUTOMATIC HANDHELD SHUT OFF:

The handheld will automatically turn off after switching off the control unit.

4.1. HANDHELD DISPLAY FUNCTIONS

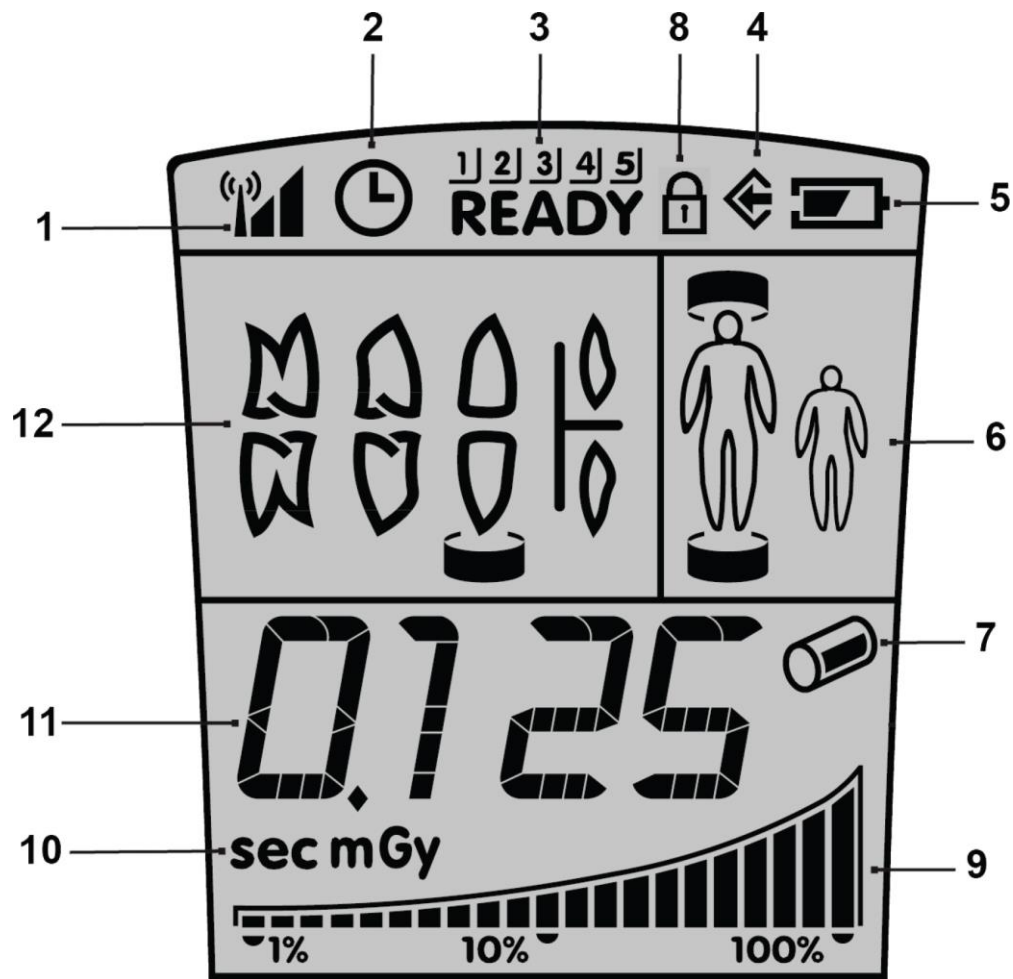

- 1 Field present for dialoguing with “base”
- 2 Pause for cooling
- 3 Handheld identification number
- 4 Memorising
- 5 Battery status
- 6 Patient size selection
- 7 8” round collimator on (12” rectangular collimator not attached)
- 8 Interlock active
- 9 Graduated bar for thermal load
- 10 Time/dose unit of measure
- 11 Exposure time and dose display
- 12 Tooth selection

4.2. USE OF HANDHELD

As illustrated in the figure below, the handheld has four function keys and a single x-ray emission key.

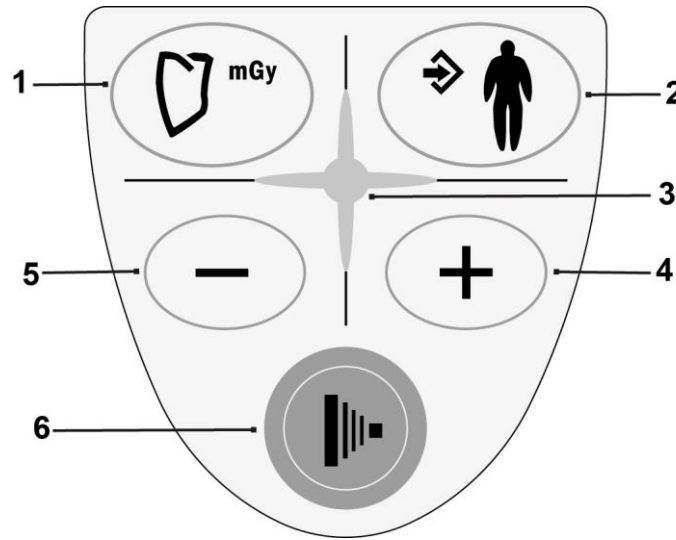

- 1 "Dentition area selection" key
- 2 "Body size selection" key
- 3 X-ray emission light
- 4 "Increase" key
- 5 "Decrease" key
- 6 "X-ray emission" key

The main functions of the keys on the handheld, depending on how they are pressed, are:

KEY	BRIEFLY PRESSED (less than 3 sec.).	PRESSED LONGER (more than 3 sec.).
	Changes over from ADULT to CHILD and vice versa (takes place when key is released).	Saves the selected setting (exposure time, sensitivity, etc...). The memo icon () lights up when the data item can be saved.
	Selects the various types of teeth to choose the area to be examined.	Displays the values corresponding to the tooth exposure times in mGy and in mGy*cm ² if pressed again.
	Increases the exposure times in steps according to the set scale.	Increases the scroll speed of the values in increasing order.
	Decreases the exposure times in steps according to the set scale.	Increases the scroll speed of the values in decreasing order.
	NO EFFECTS ARE OBTAINED IF THE KEY IS PRESSED FOR LESS THAN A SECOND.	Starts x-ray exposure (the button has to be held down throughout the x-rays emission, "dead man" function).

NOTE: "Dead man" function: the system that starts x-ray exposure with the dedicated key on the wireless handheld allows x-rays to be emitted only when the user presses and holds down the exposure key. X-ray emission will stop if the key is released ahead of time.



NOTE: The function related to pressing the key briefly is performed by pressing the key which will activate the function assigned to it. On the other hand, to perform the function carried out when the key is held down longer, press the key until the relative function is started. The buzzer will beep shortly to signal that the function has been activated.



NOTE: Warm-up: When the equipment has not been used for a prolonged period (more than 3 months) or when turned on for the first time, it is advisable to perform a series of emissions with short times (0.01-0.02 sec.) and then, progressively, some pictures with 0.1 sec. intervals to better stabilise the operation of the x-ray tube before using it.

4.3. CHECKING THE PARAMETERS

Before actually taking an exposure, make sure the exposure parameters for the examination in progress are correctly set:

- Controlling the type of collimator selected.

Make sure the cone icon shown on the handheld matches the desired cone:



ON: indicates that the x-ray unit is using the built in round cone (diameter 60mm, focal spot-skin distance 20cm).



OFF: indicates that the external removable rectangular or round cone is attached to the x-ray device (source-skin distance 30cm).

Refer to paragraph 5.3 to set the type of movable collimator used.



NOTE: After the rectangular collimator (12") has been attached or detached, the icon and set exposure times will automatically be modified within a few seconds.







- Checking the selected body build.
 - "Child" selected: indicates the x-ray unit is set for patients with small builds.
 - "Adult" selected: indicates the x-ray unit is set for patients with average-large builds.

Average/large build (ADULT) selected	Small build (child) selected



NOTE: After the change has been made, the preset exposure times will automatically be modified.

- Checking the selected type of intraoral exam.

	Upper molars		Lower incisors
	Upper canines/bicuspids or rear "bite-wing"		Lower canines/bicuspids
	Upper incisors or front "bitewing"		Lower molars

4.4. FACTORY SETTINGS

RX DC x-ray unit is supplied with the following factory settings:

- Operative mode: AUTO.
- Sensitivity: level 19.
- Handheld stand-by: 5 minutes
- Exposure times as per standard R'20: 0.020 - 0.022 - 0.025 - 0.028 - 0.032 - 0.036 - 0.040 - 0.045 - 0.050 - 0.056 - 0.063 - 0.071 - 0.080 - 0.090 - 0.100 - 0.110 - 0.125 - 0.140 - 0.160 - 0.180 - 0.200 - 0.220 - 0.250 - 0.280 - 0.320 - 0.360 - 0.400 - 0.500 - 0.560 - 0.630 - 0.710 - 0.800 - 0.900 - 1.000



NOTE: These times comply with current standards I.E.C. 60601-1-3:2008 and the ISO 497 series R'20 recommendations and CANNOT BE MODIFIED.

5. USE OF THE X-RAY DEVICE

5.1. PATIENT POSITIONING

A positioner or alignment device specific for the selected image receiver should always be used to assure the x-rays are correctly aligned regardless of the position the patient's head is in.

5.2. POSITIONING THE X-RAY HEAD

Position the x-ray head so that the cone is aligned with the image receiver.

BALL JOINT TECHNOLOGY

 **NOTE: This section applies only to models RX DC REF: MRPU*******
(Character * can be any alphanumeric value)

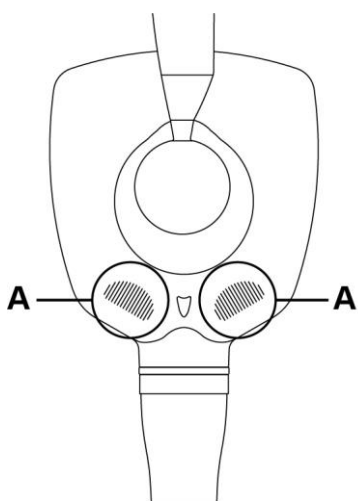

In the versions equipped with ball joint, the x-ray head can freely rotate on both its horizontal and vertical axis.

An electromechanical brake initially locks the x-ray head. To release the head and let it rotate on the positioning ball, work on the touch sensitive unlocking areas located on it (see points A in the figure on the side).

Touching the unlocking areas allows positioning the x-ray head at the desired angle to perform the exposure. To lock it again, simply release the unlocking areas.

 **NOTE: Firmly hold the x-ray head with both hands when putting it in place.**

It is possible to set a safety unlocking mode that allows the head to be turned only by pressing both unlocking buttons. This prevents the head from unlocking unexpectedly after one of the two unlocking buttons has been accidentally pressed. To activate this mode, refer to section 5 "Advanced options".

ARCH TECHNOLOGY

 **NOTE: This section applies only to models RX DC REF: MRXU*******
(Character * can be any alphanumeric value)

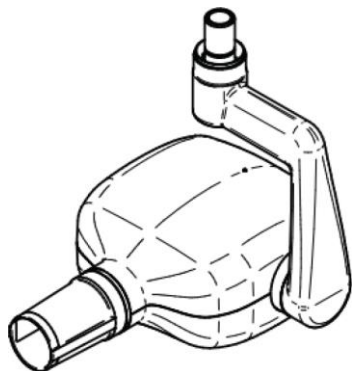

In the versions equipped with arch technology, the x-ray head can freely rotate on both its horizontal and vertical axis.

Simply moving the x-ray head allows positioning it at the desired angle to perform the exposure.

5.3. POSITION OF THE X-RAY PLATE OR SENSOR

The parallel technique, where applicable, provides more accurate images in terms of size compared to the bisecting technique. A rectangular collimator, with 30 cm (12"), focus-skin distance, is always preferable to obtain better quality pictures. To avoid exposing the image receiver only partly (whether it is a sensor or photostimulable phosphorus plate system) an alignment device that gives rectangular collimators guidelines should be used. These lines are usually given on the alignment ring.

- Parallel technique.

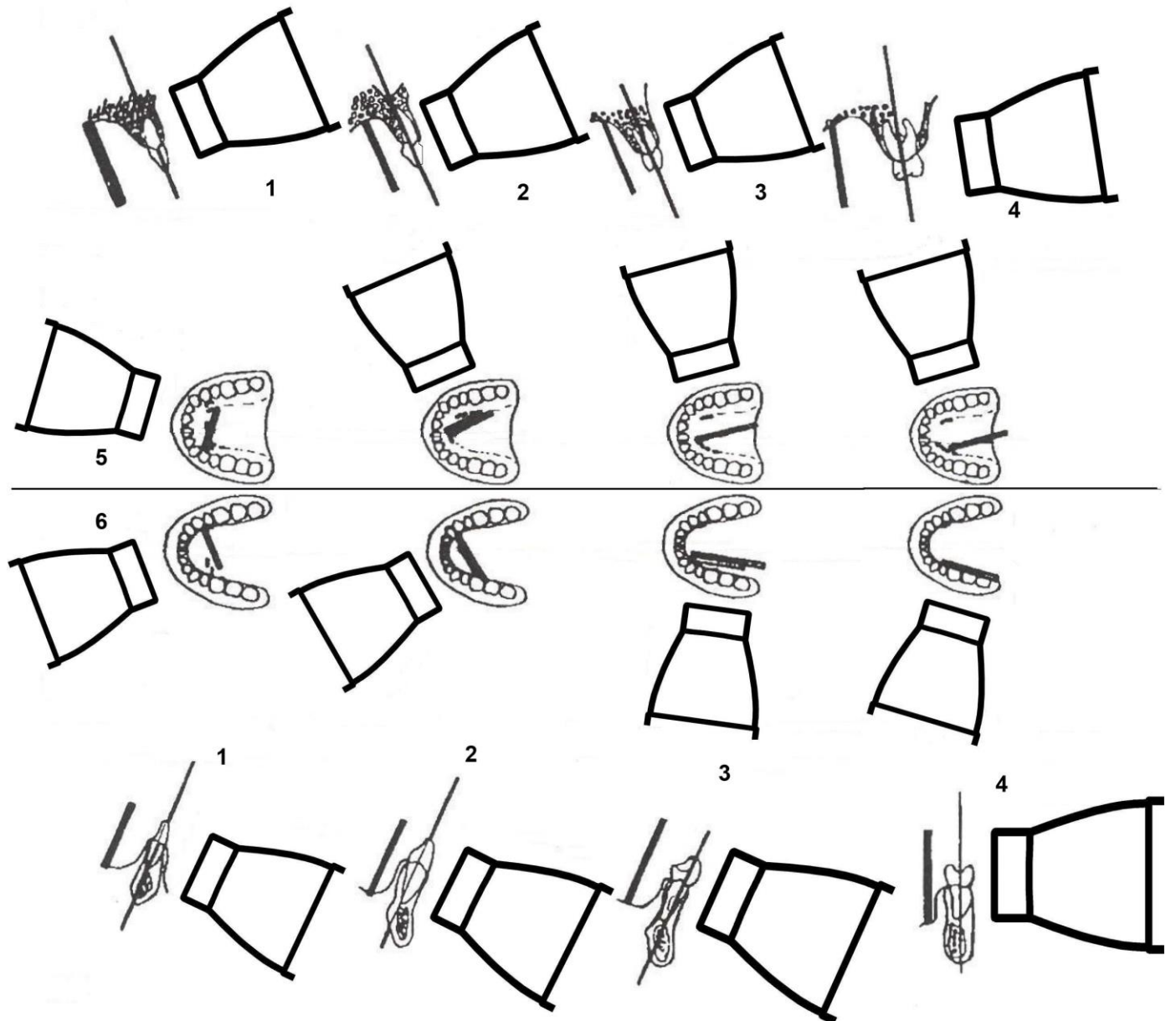

- 1 Incisors
- 2 Canines
- 3 Premolars
- 4 Molars
- 5 Upper arch
- 6 Lower arch

- The x ray emission axis is perpendicular to the image receiver (for example a sensor or photostimulated phosphor plate) which in turn is parallel with the tooth's long axis.
- As a result, the picture of the tooth will only be deformed by the divergence of the x rays in relation to the focus spot.
- Radiographic enlargement may reach up to 15%.
- For some "special" pictures, for example occluded ones, it may be necessary to remove the rectangular collimator and use the round one if a positioner is not present.

5.4. SETTING THE EXPOSURE MODE AND TIME

The exposure parameters are set by following the directions given below:

- 1) Select the tooth to be examined
- 2) Select the patient size

The exposure time is automatically shown on the handheld screen.



 **NOTE:** Each tooth and patient size selected is displayed for approximately 1 second according to the operating mode used (En60, En63 o En65).

 **NOTE:** This section applies only to models RX DC REF: MRPU*6***, MRXU*6***
(Character * can be any alphanumeric value)



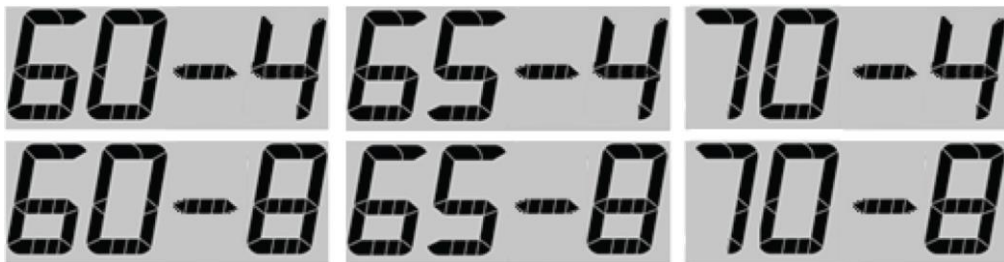



 **NOTE:** This section applies only to models RX DC REF: MRPU*7***, MRXU*7***
(Character * can be any alphanumeric value)



The suggested exposure time can be changed with keys  and . Exposure times ranging from 0.01s to 1.00s belonging to the R'20 scale can be set. Random exposure times different from the ones provided in the R'20 scale cannot be set.

When the exposure time displayed differs from the default setting, icon  comes on.

To save the new setting, make sure that icon  is on and then press and hold down key  for approximately 2 seconds. The handheld will beep shortly to confirm that the setting has been saved. At this point, make sure that icon  is off.

 **NOTE:** If the exposure time is not saved, the change made will be lost after a new entry or as soon as the handheld changes over to stand-by.



WARNING:



After customised settings have been made, the “Original exposure values charts” are no longer valid.

If icon  is displayed while the exposure time is changed, it means that the set time cannot be saved for the selected tooth-patient size combination. In any case, the x-rays can be taken with the set time.







WARNING:

When the suggested exposure time is changed, the sensitivity factor is also modified (by default set to F=19). Once this change has been saved, it is applied to all the teeth and both patient sizes.

The exposure time can also be modified by changing the sensitivity factor. To do so, press keys  and  at the same time; the actual sensitivity factor will be displayed.



Use keys  and  to change the value from 3 to 25. If the displayed value differs from the previous setting, icon  comes on. To quit this mode, press key  or . The change made to the sensitivity factor is applied to all the teeth and both patient sizes.

The operating mode selected is always used for each combination of tooth and patient size. In AUTO mode, each tooth and patient size combination is associated to the best mode from amongst the ones available. In this mode, it is not possible to assign a mode other than the default one to each combination.

5.5. PROCEDURE TO BE FOLLOWED WHEN TAKING THE X-RAY

- Pick up the handheld and move to a safe distance (at least 2 meters) maintaining visual contact with the patient and x-ray unit during the exposure. Make sure "ready" is indicated.

READY

- Tell the patient to stay still.
- Press and hold down the "Exposure" key on the handheld until the audible warning sound (beep) stops and the yellow light goes out.





"X-ray emission light" key

Light on control panel illuminated during x-ray emission.

 **NOTE: If the "EMIT X-RAY" key is released at any time, exposure will be interrupted and error code E01 will appear on the display.**

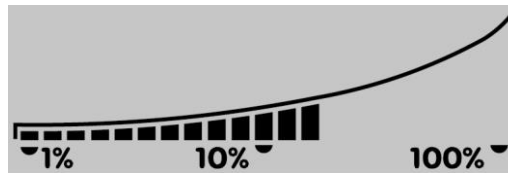
- Once exposure has been completed, it is possible to proceed with the next exposure unless the x-ray unit has reached the maximum allowable temperature. The percentage the cone exceeds the maximum allowable temperature is always shown on the screen (see icon below).



- Once the temperature has been reached, wait the pause time for cooling signaled by symbol .
- At this point the exposure function will be disabled until the screen shows "ready" again
- As soon as "READY" appears on the handheld, another exposure can be taken.

6. ADVANCED OPTIONS

The handheld allows the user to view, edit and set some operating parameters by simply combining the keys provided. Follow the steps outlined below to access:

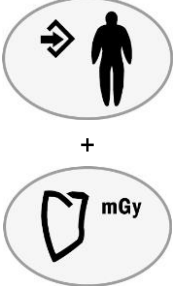
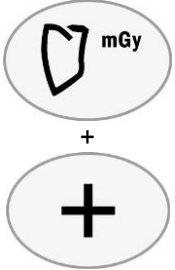
KEY COMBINATION	DESCRIPTION OF COMMAND
	<p>Press these two keys to adjust the sensitivity levels (determined based on the table given below and type of sensor/receiver used), modifying the current value from the minimum to the maximum allowable one (on a scale from 3 to 25), with keys “+” and “-”. Press key “size” to confirm the desired level and go back to the main screen.</p>
	<p>Hold down these two keys to go to the set-up menu (from P 01 to P 07). Press key “size” to make the selection. Once within the individual configurations, they can be scrolled with keys “+” and “-” and selected by pressing key “size” again. Key “tooth” quits the configuration without saving the setting. The configurations are outlined in detail below:</p> <ul style="list-style-type: none"> - P 01: Sets the stand-by time (from a minimum of 5 to a maximum of 30 minutes). - P 02: Assigns an identification tag to the x-ray unit base (from 1 to 5 or none). - P 03: Shows the list of software versions. - P 04: Handheld unique code display. - P 05: Activates/deactivates the safety unlock mode (only with ball joint). - P 06: Operating mode. - P 07: Sets the type of removable collimator used. - P 08: Set current value (only for 70kV x-ray heads).

SETTING THE SAFETY UNLOCKING MODE

 **NOTE: This section applies only to models RX DC REF: MRPU*******
(Character * can be any alphanumeric value)

X-ray unit has a safety unlocking mode for the ball joint.

The default setting allows the ball joint to be disengaged by simply touching one of the buttons present on the front of the head. To prevent accidental contact with the buttons unexpectedly disengaging the ball joint (and therefore causing undesired movement of the head), the safety unlocking mode can be activated. In this mode, the ball joint is disengaged only if both buttons are activated at the same time.

To set the safety unlocking mode, press keys  and  to go to the set-up menu.

Scroll the parameters up to parameter P05 and press key . Scroll the options to select “ON” and then press key



Press key  to quit the setup menu.

6.1. SETTING THE OPERATING MODE

X-ray unit features the following operating modes:

- **AUTO:** the system automatically selects the best setting available for each tooth-patient size combination
- **USER:** the system automatically proposes the optimum exposure time according to the selected tooth and patient size - En65: all exposures are performed at 65KV and 6mA.

For both operating modes, the exposure time is in the range 0.02s - 1s. The permitted anode voltage and current combinations are shown in the following table:

 **NOTE: This section applies only to models RX DC REF: MRPU*6***, MRXU*6*****
(Character * can be any alphanumeric value)

60-7	60 kV	7 mA
63-6	63 kV	6 mA
65-6	65 kV	6 mA

 **NOTE: This section applies only to models RX DC REF: MRPU*7***, MRXU*7*****
(Character * can be any alphanumeric value)

60-8	60 kV	8 mA
65-8	65 kV	8 mA
70-8	70 kV	8 mA
60-4	60 kV	4 mA
65-4	65 kV	4 mA
70-4	70 kV	4 mA

To set the operative mode, press keys  and  to go to the setup menu.

Scroll the parameters up to parameter P06 and press key . Scroll the options to find the desired operating mode and then press key .

Press key  to quit the setup menu.

6.2. SETTING TYPE OF MOVABLE COLLIMATOR

X-ray unit features the following movable collimators:

- Rectangular 35x45 mm (only with ball joint)
- Round ø55 mm
- Rectangular 31x41 mm (to apply on round collimator ø55 mm)
- Rectangular 22x35 mm (to apply on round collimator ø55 mm)





NOTE: For an ideal use of the x-ray unit, set the collimator depending on the type used.



To set the type of collimator, press keys  and  to go to the set-up menu.

Scroll the parameters up to parameter P07 and press key . Scroll the options to find the type of collimator used and then press key .

Press key  to quit the setup menu.

6.3. RESTORING FACTORY SETTINGS

To restore the factory settings (see paragraph 4.4) press keys  and  to go to the set-up menu.

Press keys  and  simultaneously. “rESS” will briefly appear and the handheld will be rebooted.



7. ERROR MESSAGES

ERROR	CAUSE	SOLUTION
E01	X-RAY KEY RELEASED TOO EARLY	Hold down the key until the image has been captured.
E02	SHOOTING SEQUENCE NOT COMPLETED	Handheld most likely lost the signal. Try to repeat exposure. If the problem persists, contact the technical service department.
E03	HANDHELD INTERNAL TEST ERROR	Take out the batteries and then put them back in after waiting a few seconds. If the problem persists, contact the technical service department.
E04 E05 E08	HANDHELD AUTO DIAGNOSIS TEST FAILED	Contact technical service department.
E06	GENERAL HANDHELD ERROR	Try to repeat exposure. If the problem persists, contact the technical service department.
E07	RF SIGNAL TOO LOW	Handheld lost the signal. Try to repeat exposure. If the problem persists, contact the technical service department.
E09	HANDHELD SERIAL NUMBER INCORRECT OR NOT INITIALIZED	Contact technical service department.
E10 E12 E13 E16	X-RAY UNIT INTERNAL ERROR	Contact technical service department
E11	COLLIMATOR SELECTION NOT CONSISTENT	After turning the rectangular collimator on or off, wait a few seconds to allow the icon on the handheld to be updated.
E14 E15	GENERAL GENERATOR ERROR	Contact technical service department
E17	DEVICE OVERHEATING	Wait approximately 15 minutes for automatic system reset
E18 E19	HEAD RELEASED	Check the supply system. If the problem persists, contact the technical assistance department.
E30	SUPPLY VOLTAGE TOO HIGH/LOW	Repeat the x-ray. If the problem persists, contact the technical assistance department.
E31 E32	INTERNAL ADJUSTMENT PROBLEM	Reduce the distance between the remote control and x-ray head and then repeat the x-ray. Follow the information given on how to properly use the handheld's antenna. If the problem persists, contact the technical service department.
E33	REMOTE CONTROL ERROR	X-ray generator or arm cord may be faulty. Contact technical service department.
E34	INTERLOCK ERROR	Close the door and if necessary repeat the test.

 **NOTE:** Just press button  to exit error condition

NOTE: As regards the other error codes, CONTACT the technical service department.

8. PERIODIC MAINTENANCE



WARNING:

Any technical maintenance work required must be carried out by qualified personnel or by a specialised technician authorised by the manufacturer. It is the user's responsibility to check that an authorised technician carries out routine maintenance at least every year. The maintenance methods are specified in the Technical Service Manual possessed by the Authorised Technicians

For safety reasons and for the health of the patient, operator and third-parts inspections and maintenance must be carried out at regular intervals.

Period	Operator	Object	Description
1 year	Specialised technical distributor who installed the device or other technicians authorised by the manufacturer	All device components are integral parts of the unit	In order to ensure the safety of operation of the device, it is advisable to inspect the x-ray unit in all its parts, in order to prevent or repair any faults

Quality control by means of a dental phantom for image acquiring systems, according to IEC 61223-3-4:2000:

Image resolution (lp/mm)	4lp/mm
Low contrast resolution	2
Artifacts	In the image, there must be no artifacts such as visible horizontal lines
Control period	1 year

The quality control consists in performing a radiological investigation by means of the tested device and the acquisition system Zen-X or X-Pod. The sensitivity of the x-ray unit must be set according to what is stated in paragraph 14.

Alternatively, you can verify that the measured load factors (kV, mA, ms) fall within the accuracy limits stated in Section 11.

Periodic monitoring ensures the proper functioning of the device and the conformity of the results obtained.

9. CLEANING AND DISINFECTION



- Cleaning is the first necessary step for any disinfection process. Rubbing with detergents and surfactants and rinsing with water removes allows removing a considerable number of microorganisms. If a surface is not cleaned first, the disinfection process cannot be successful.

The x-ray unit can be a source of cross-contamination between patients.

For this reason it should be disinfected on the outside every day after use.

If digital x-ray sensors are used, make sure that they are always used with disposable hygienic covers.

Use soft disposable paper towels to disinfect the x-ray unit. Do not use harsh products or soak in liquids.

It is recommended to use the specific medium-level disinfectant, STER 1 PLUS (CEFLA S.C.), which is compatible with painted surfaces, plastic parts and unpainted metal surfaces. Alternatively, it is recommended to use products that contain:

- **96% ethanol.**
Concentration: maximum 30 g for every 100 g of disinfectant.
- **Propanol.**
Concentration: maximum 20 g for every 100 g of disinfectant.
- **Combination of ethanol and propanol.**
Concentration: the combination of the two should be maximum 40 g per 100 g of disinfectant.

Compatibility tests between plastics and the following products have been carried out with no negative consequences:

- Incidin Spezial (Henkel Ecolab);
- Omnizid (Omnident);
- Plastisept (Alpro) (not tuberculocide as not an alcohol-based disinfectant);
- RelyOn Virkosept (DuPont);
- Green & Clean SK (Metasys) (not tuberculocide as not an alcohol-based disinfectant).



- Do not use products containing isopropyl alcohol (2-propanol, iso-propanol).
- Do not use products containing sodium hypochlorite (bleach).
- Do not use products containing phenols.
- Do not spray the selected products directly on the surfaces.
- Never combine products with each other or with liquids other than the products listed above.
- All products must be used as directed by the manufacturer.



- The recommended products have been tested: they are technically compatible with the device materials.
- Damages to surfaces and materials due to the use of different products cannot be excluded even if they are not included in the exceptions mentioned above.

Cleaning and disinfecting instructions.

Clean and disinfect with disposable soft, non-abrasive paper (avoid using recycled paper) or sterile gauze.

Do not use sponge cloths or, in any case, any material that can be reused.



- Turn off the device prior to cleaning and disinfecting the external parts.
- Never lubricate the pivot point of the x-ray head as proper operation of the locking system may be compromised.
- All material used to clean and disinfect must be thrown away upon completing the procedure.

10. DISPOSING THE EQUIPMENT WHEN NO LONGER USED



WARNING!
Never remove the device covers.

The device does not contain parts that can be repaired directly by the user. In the event of malfunctioning, do not attempt to carry out any type of maintenance operation. If you find or suspect any kind of system malfunctioning, do not attempt to carry out any type of maintenance operation and do not use the system on a patient, but directly contact your local distributor.

The user may not carry out maintenance on any mechanical or electronic part of the x-ray system.

Opening the cases to access the internal circuits may cause device breakage and failure of the electrical safety devices and will lead to forfeiture of the warranty.

Any maintenance, repairs and modifications of the device must be carried out only by personnel directly authorised by the manufacturer or by third parties expressly authorised by the manufacturer and must be carried out according to the laws in force and the generally accepted technical standards.

All the system components must be checked and replaced, if necessary, by qualified personnel.

For any maintenance operation, please contact the manufacturer via the website indicated on the cover of this manual by filling in the Information Request form.

Should you for any reason need to return the device or its parts to the manufacturer or a Technical Service centre, disinfect all the external parts of the device using a specific product (see the paragraph "Cleaning and disinfection") and preferably return it in its original packaging.

At the end of its lifetime, dispose of the device in accordance with the regulations in force. It is also advisable to disinfect all the external parts of the device before disposal and to separate the materials for differentiated waste collection.

In accordance with Directives 2002/95/EC, 2002/96/EC and 2003/108/EC regarding reduced use of dangerous substances in electrical and electronic devices as well as waste disposal, do not dispose of the devices in the household waste but collect them separately.

When purchasing a new device of an equivalent type, one for one, the device that has come to the end of its lifetime should be returned to the dealer for disposal.

As regards reuse, recycling and other forms of recovery of the above mentioned waste, the manufacturer carries out the functions defined in the individual national legislations.

Appropriate differentiated waste collection for subsequent recycling treatment and environmentally friendly disposal contributes to preventing possible negative effects on the environment and health and encourages recycling of the materials of which the device is made up.

The crossed-out bin symbol on the device indicates that the product must be collected separately from other waste at the end of its useful life.



WARNING!
Abusive disposal of the product is liable to a fine as laid down in the individual national legislations.

11. TECHNICAL DATA



NOTE: This section applies only to models RX DC **REF:** MRPU*7***, MRXU*7***
(Character * can be any alphanumeric value)

Specification for 70kV x-ray head:

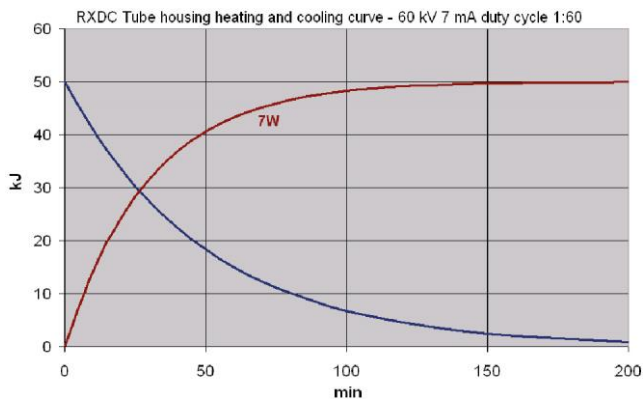

- Rated voltage: 230-240 Vac or 115-120 Vac (according to the model).
- Max. mains voltage fluctuation: $\pm 10\%$.
- Rated current: 6A for the 230-240Vac version; 10A for the 115-120Vac version.
- Frequency: 50/60Hz.
- Maximum power absorbed: 1.4KVA.
- Apparent line resistance: 0.5Ω (240Vac), 0.2Ω (120Vac).
- Protective fuses: 8A T for the 230-240Vac version; 12A T for the 115-120Vac version.
- Generator: constant potential type.
- High nominal voltage: 60 / 65 / 70 kV.
- Anode current: 4 / 8mA.
- Load factors for the maximum electric power: 70kV 8mA (560W).
- Input anodic continuous power: 7W.
- Current - reference time product: 0.8 mAs (8mA - 0.1s) / 0.4 mAs (4mA - 0.1s).
- Focal spot (according to IEC 60336:2005):
0.4mm (with TOSHIBA D-041, Kailong KL11-0,4-70, CEI OX/70-3)
0.7mm (with TOSHIBA D-0711 or Kailong KL21-0,7)
- Anode construction material: Tungsten (W).
- Total filtration: 2mm Al @ 70kV.
- Leaked radiation: $< 0.25\text{mGy} / \text{h}$ at 1 metre from focus with load factor 70kV 8mA 1s and duty cycle 1:80.
- Tolerance for position of the focal spot along the reference axis: $\pm 2\%$.
- Set exposure time: from 0.020 to 1.000 seconds.
- Accuracy of times indicated: $\pm 5\%$ or $\pm 5\text{ms}$.
- Coefficient of variation of KERMA < 0.05 .
- Linearity error of KERMA < 0.2 .
- Dose indication accuracy (mGy): $\pm 30\%$.
- Maximum deviation of stated values:
kV: $< 5\%$
mA: $< 10\%$

.WEIGHTS

- Weight of the unit with packaging: 38Kg (84lb) max.
- Weight of the x-ray unit: 25Kg (55 lb).
- Weight of the handheld: 0.3Kg (0.7 lb).
- Weight of the x-ray mobile stand: 20Kg (44 lb).



NOTE: This section applies only to models RX DC REF: MRPU*6***, MRXU*6***
(Character * can be any alphanumeric value)

Specification for 65kV x-ray head:

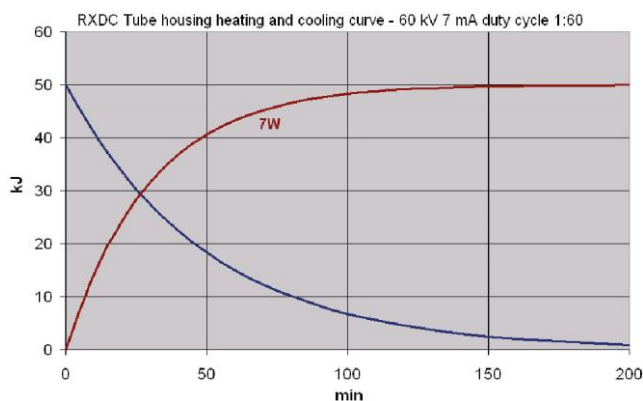

- Rated voltage: 230-240 Vac or 115-120 Vac (according to the model).
- Max. mains voltage fluctuation: $\pm 10\%$.
- Rated current: 6A for the 230-240Vac version; 10A for the 115-120Vac version.
- Frequency: 50/60Hz.
- Maximum power absorbed: 1.4kVA.
- Apparent line resistance: 0.5Ω (240Vac), 0.2Ω (120Vac).
- Protective fuses: 8A T for the 230-240Vac version; 12A T for the 115-120Vac version.
- Generator: constant potential type.
- High nominal voltage: 60 / 63 / 65 kV.
- Rated current: 6 / 7mA.
- Load factors for the maximum electric power: 60kV 7mA (420W).
- Input anodic continuous power: 7W.
- Current - reference time product: 0.7 mAs (7mA - 0.1s) / 0.6 mAs (6mA - 0.1s).
- Focal spot (according to IEC 60336:2005):
0.4mm (with TOSHIBA D-041, Kailong KL11-0,4-70, CEI OX/70-3)
0.7mm (with TOSHIBA D-0711 or Kailong KL21-0,7)
- Anode construction material: Tungsten (W).
- Total filtration: 2mm Al @ 65kV.
- Leaked radiation: $<0.25\text{mGy/h}$ at 1 metre from focus with load factor 65kV 6mA 1s and duty cycle 1:60.
- Tolerance for position of the focal spot along the reference axis: $\pm 2\%$.
- Set exposure time: from 0.020 to 1.000 seconds.
- Accuracy of times indicated: $\pm 5\%$.
- Coefficient of variation <0.05 .
- Linearity error <0.2 .
- Dose indication accuracy (mGy): $\pm 30\%$.
- Maximum deviation of stated values:
kV: $< 5\%$
mA: $< 10\%$

WEIGHTS

- Weight of the unit with packaging: 38Kg (84lb) max.
- Weight of the x-ray unit: 25Kg (55 lb).
- Weight of the handheld: 0.3Kg (0.7 lb).
- Weight of the x-ray mobile stand: 20Kg (44 lb).

11.1.X-RAY TUBES

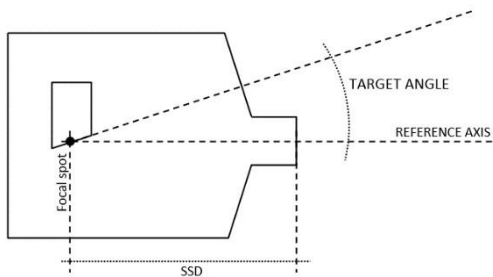
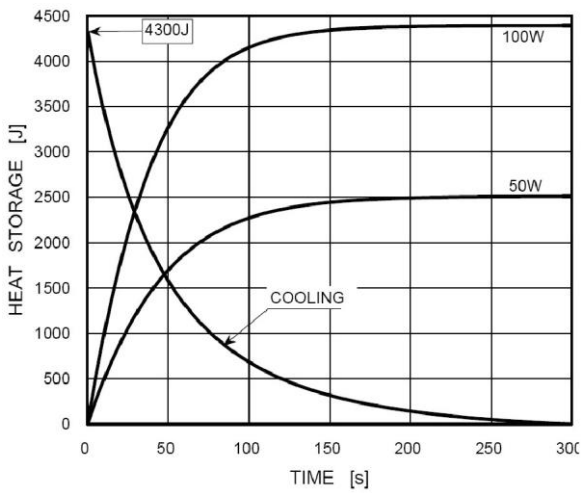

X-RAY TUBE TOSHIBA D-041, TOSHIBA D-045, Kailong KL11-0,4-70

- Anode inclination: 12.5° (with TOSHIBA D-041, TOSHIBA D-045)
- Anode inclination: 12° (with Kailong KL11-0,4-70)
- Anode thermal load: 4.3 KJ

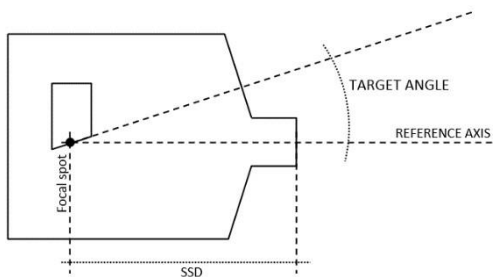
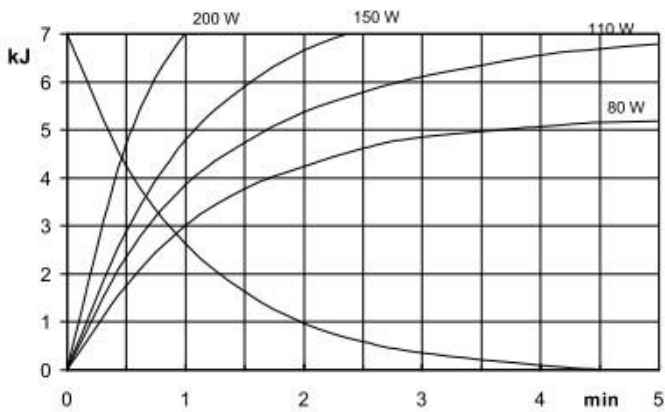

X-RAY TUBE CEI OX/70-3

- Anode inclination: 13°
- Anode thermal load: 7 KJ
- Maximum continuous heat dissipation: 100 W.
- Operating cycle: 1:60 (1 second exposure - 60 seconds pause time).

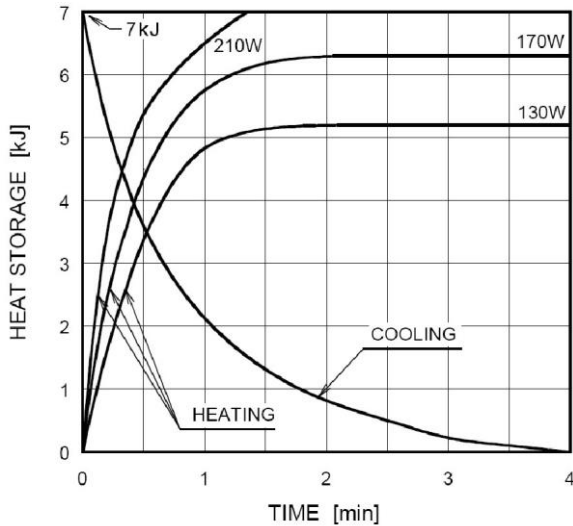

X-RAY TUBE TOSHIBA D-0711, Kailong KL21-0,7.

- Anode inclination: 16.0°
- Anode thermal load: 7.0 KJ
- Maximum continuous heat dissipation: 170 W.
- Operating cycle: 1:60 (1 second exposure - 60 seconds pause time).

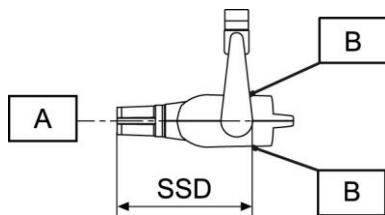
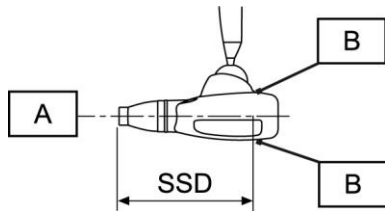
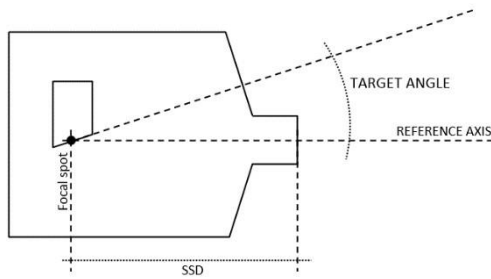

COLLIMATOR TECHNICAL SPECIFICATIONS

- With rectangular collimator: SSD=30cm (12"), x-ray beam less than or equal to 45x35mm.
- With round collimator: SSD=30cm (12"), x-ray beam less than or equal to 55mm.
- Without rectangular collimator: SSD=20cm (8"), x-ray beam less than or equal to Ø60mm.

A) REFERENCE AXIS

B) FOCAL SPOT IDENTIFICATION

11.2. TECHNICAL FACTOR MEASURE

The high voltage value is measured with a non-invasive instrument.

The anode current is controlled inside with measurement resistors and circuits to obtain very precise measurements. Operation of the circuits is checked at the time of testing. Once assembled, the anode current can no longer be directly measured.

The exposure time should be evaluated by measuring the time that elapses from the moment in which high voltage exceeds 75% of the nominal value to the moment in which it drops below this value. Considering the high gradient of the rising and trailing edges of the anode voltage and squaring due to inherent filtration, use of a threshold ranging from 25% to 75% may be considered non-influential.

12. DIMENSIONAL CHARACTERISTICS

WALL-MOUNTED VERSION WITH ARCH

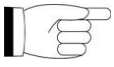

NOTE: This section applies only to models RX DC REF: MRXU****S
(Character * can be any alphanumeric value)

All dimensions are expressed in millimetres (inches).

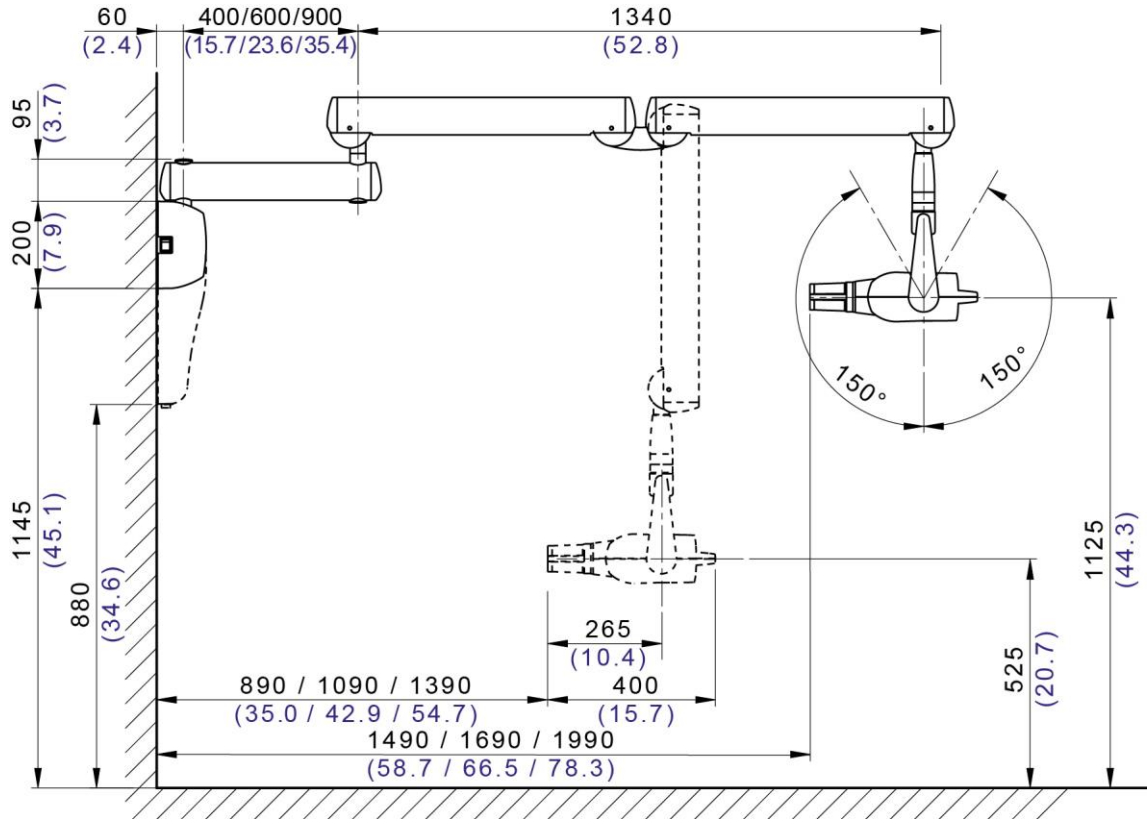

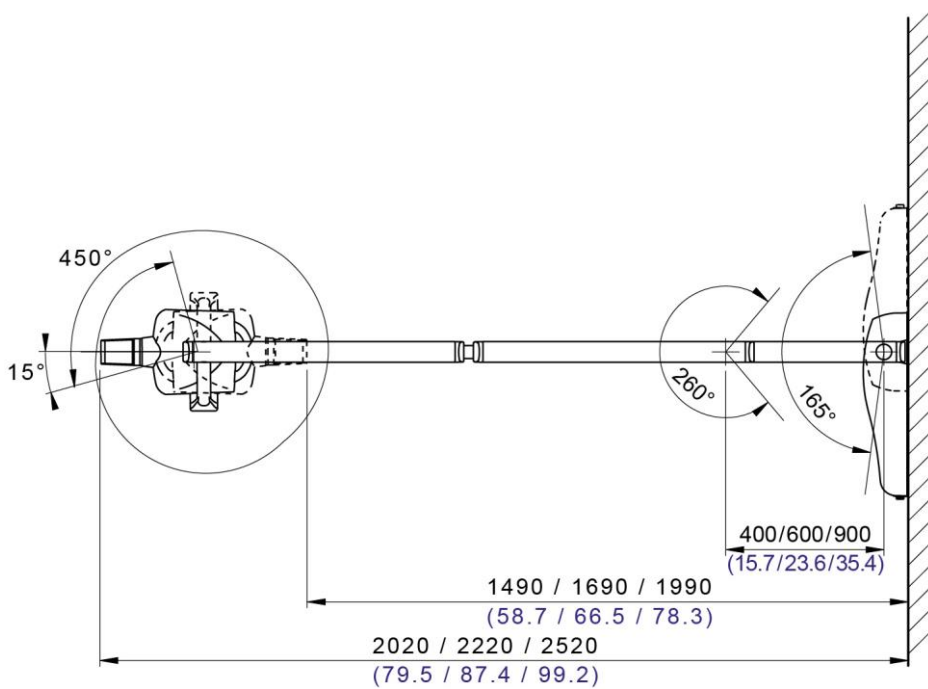
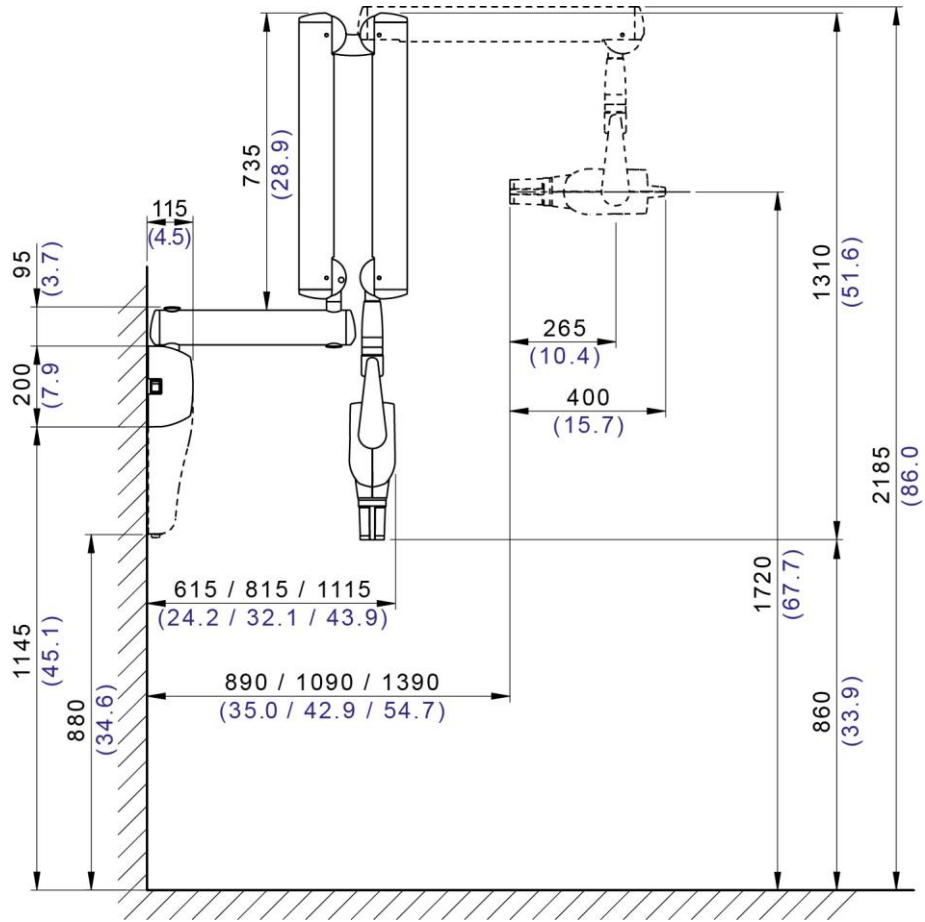

WALL-MOUNTED VERSION WITH BALL JOINT



NOTE: This section applies only to models RX DC **REF:** MRPU****S
(Character * can be any alphanumeric value)

All dimensions are expressed in millimetres (inches).

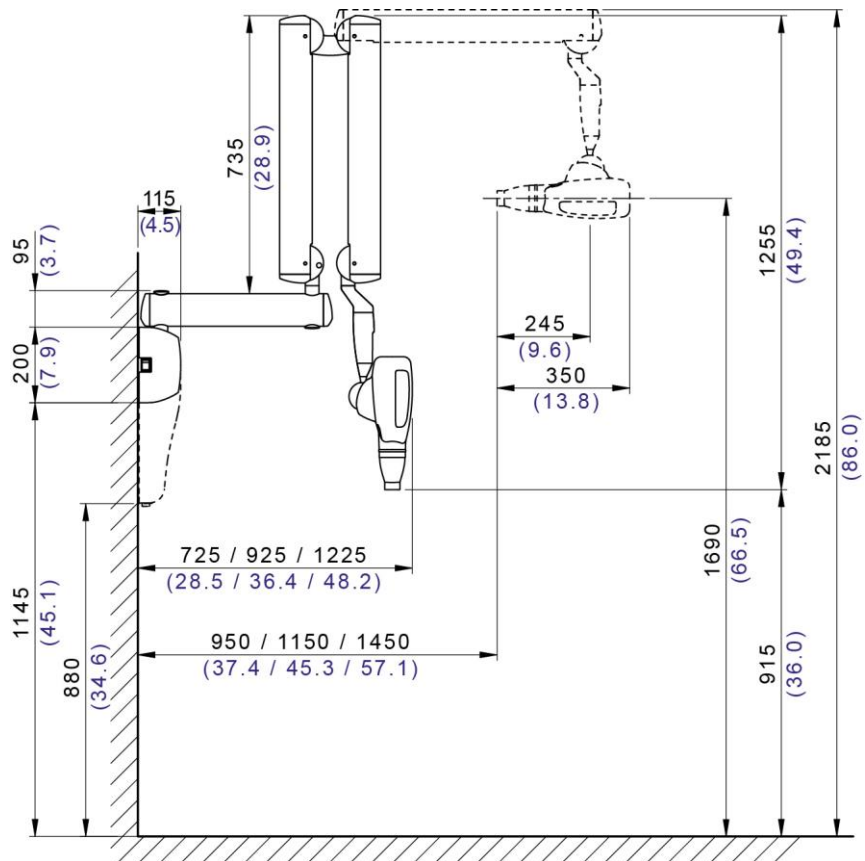
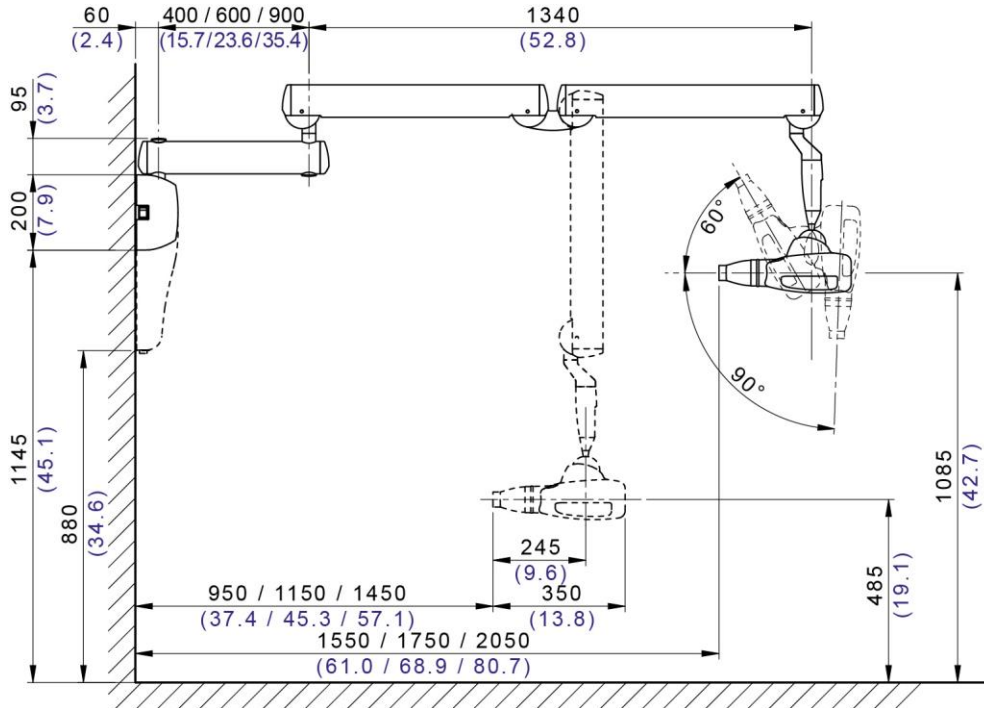

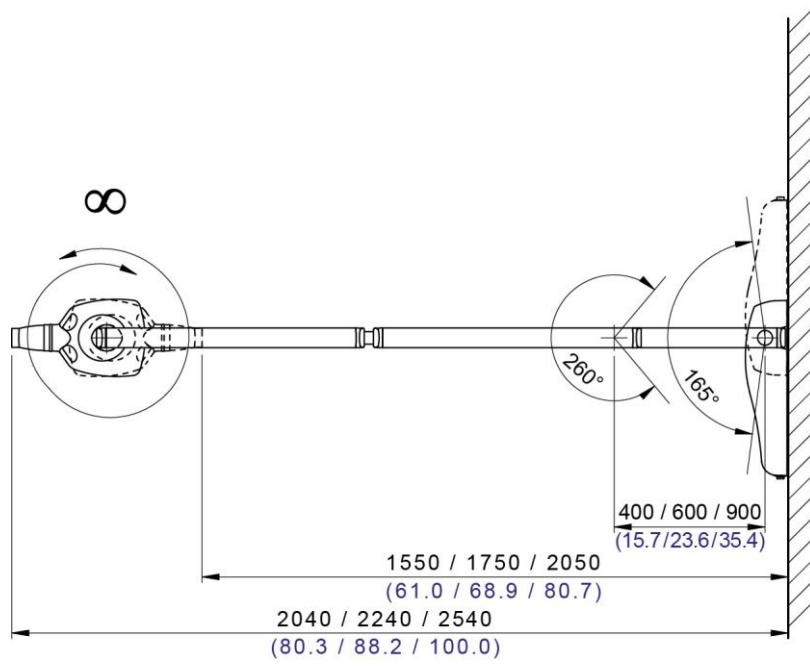

INTEGRATED VERSION



NOTE: This section applies only to models RX DC [REF]: MRPU****I
(Character * can be any alphanumeric value)

All dimensions are expressed in millimetres (inches).

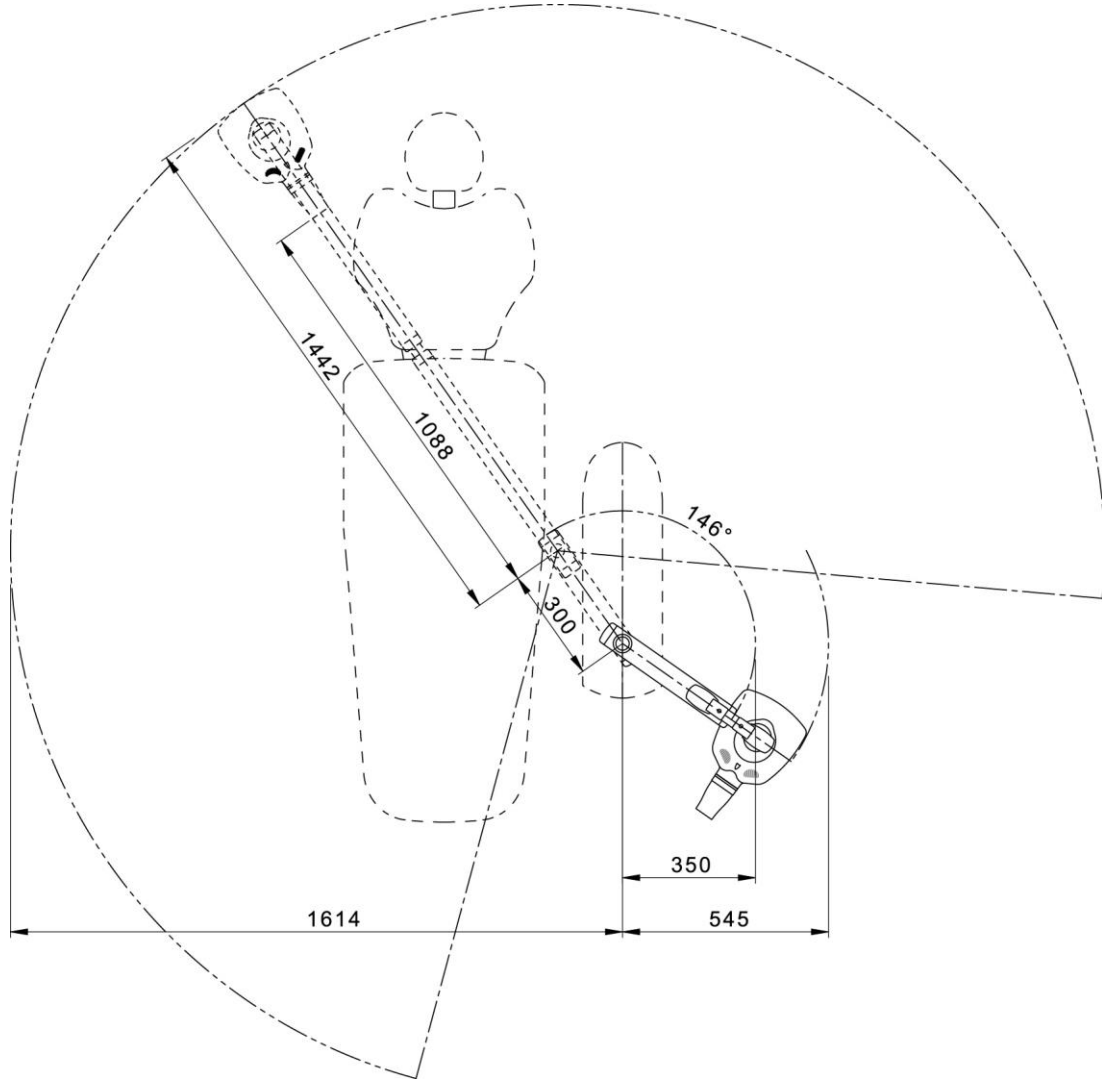

MOBILE STAND VERSION



NOTE: This section applies only to models RX DC REF: MRXU****M
(Character * can be any alphanumeric value)

All dimensions are expressed in millimetres (inches).

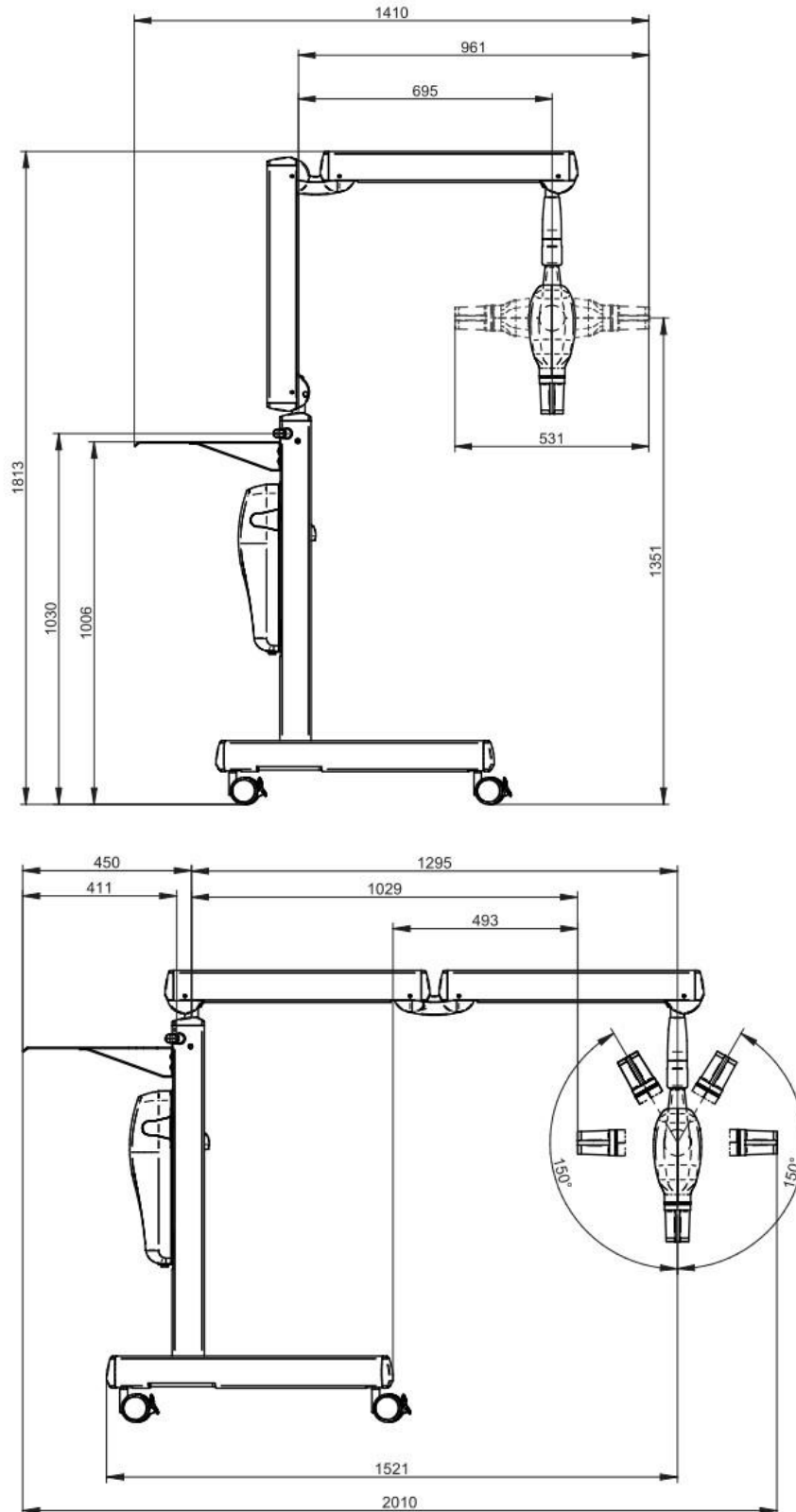

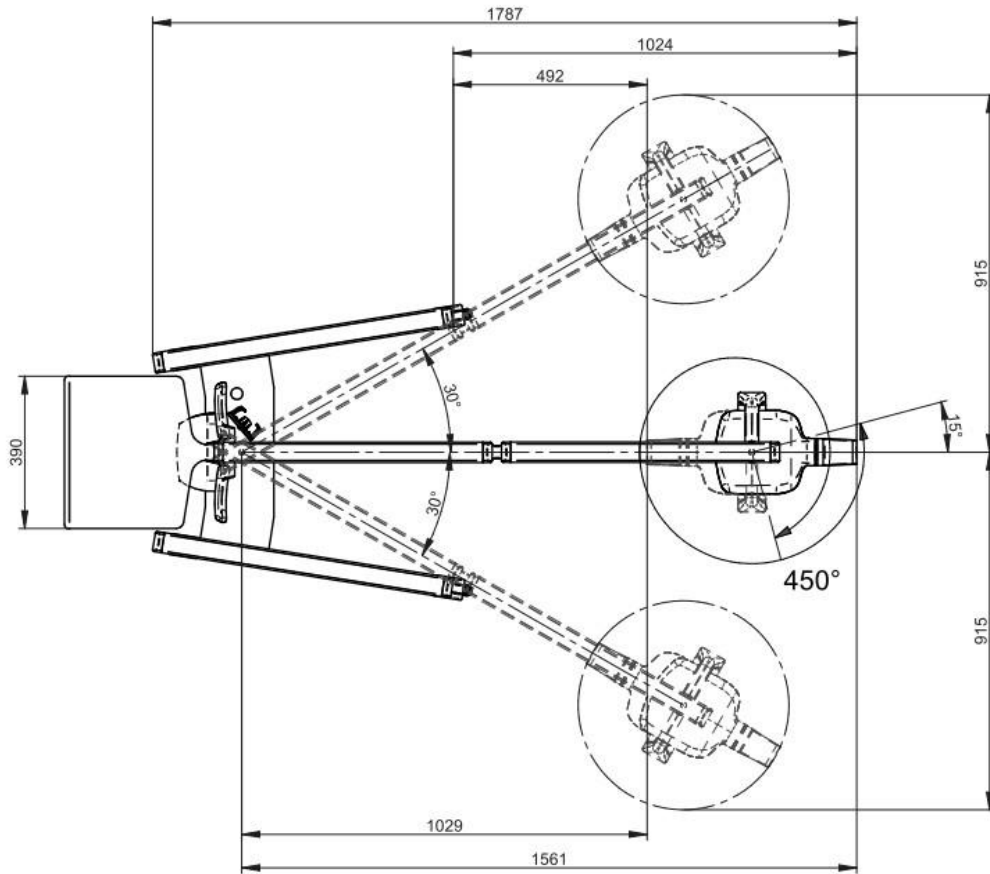

13. IDENTIFICATION PLATES



WARNING:

Never remove the identification nameplates provided on the generator, control unit and collimator cone.



NOTE: This section applies only to models RX DC REF: MRPU****S
(Character * can be any alphanumeric value)

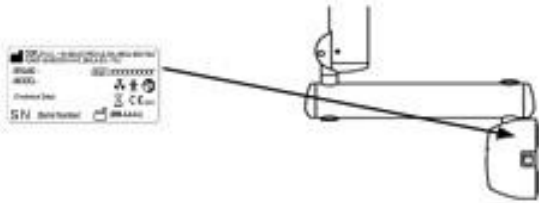

Control unit (MAIN NAMEPLATE).

The nameplate is located beside the main switch
Data given on plate:

- Name and address of the manufacturer.
- Brand and model of equipment.
- Rated voltage.
- Type of current.
- Rated frequency.
- Maximum current absorbed.
- Serial number.
- Month and year of manufacture.
- Approval marks.
- Symbol required by standards.

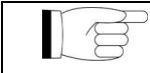

NOTE: This section applies only to models RX DC REF: MRPU****I
(Character * can be any alphanumeric value)

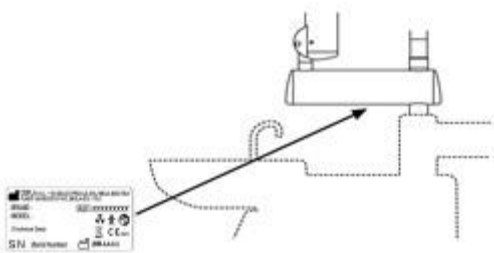

Control unit (MAIN NAMEPLATE).

The plate is located under the extension arm.
Data given on plate:

- Name and address of the manufacturer.
- Brand and model of equipment.
- Rated voltage.
- Type of current.
- Rated frequency.
- Maximum current absorbed.
- Serial number.
- Month and year of manufacture.
- Approval marks.
- Symbol required by standards.

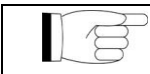

NOTE: This section applies only to models RX DC REF: MRXU****M
(Character * can be any alphanumeric value)



Control unit (MAIN NAMEPLATE).

The nameplate is located beside the main switch.
Data given on plate:

- Name and address of the manufacturer.
- Brand and model of equipment.
- Rated voltage.
- Type of current.
- Rated frequency.
- Maximum current absorbed.
- Serial number.
- Month and year of manufacture.
- Approval marks.
- Symbol required by standards.

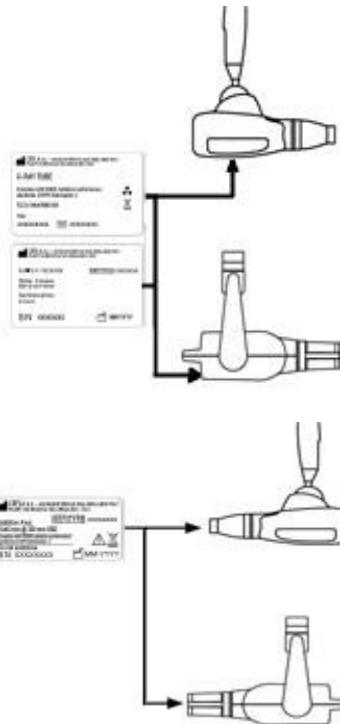

X-ray head.

The nameplate is located on the lower cover at the back of the x-ray head.

Data given on plate:

- Name of manufacturer.
- Name of equipment.
- Technical specifications.
- Model and x-ray tube serial number.
- Equipment serial number.
- Month and year of manufacture.
- Symbol required by standards.

Collimator.

The nameplate for the rectangular collimator is found outside it.

Data given on plate:

- Name and address of the manufacturer.
- Equipment code.
- Technical data.
- DHHS compliance.
- Serial number.
- Month and year of manufacture.



NOTE: This section applies only to models RX DC **REF:** MRPU***W*, MRXU***W*
(Character * can be any alphanumeric value)

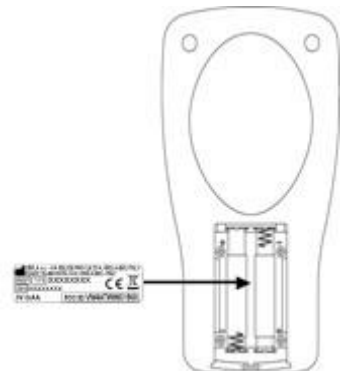

Wireless handheld.

The nameplate for the handheld is found in the battery compartment.

Data given on plate:

- Name of manufacturer.
- Name of equipment.
- Rated voltage.
- Number and type of batteries.
- Serial number.



NOTE: This section applies only to models RX DC **REF:** MRPU***C*, MRXU***C*
(Character * can be any alphanumeric value)

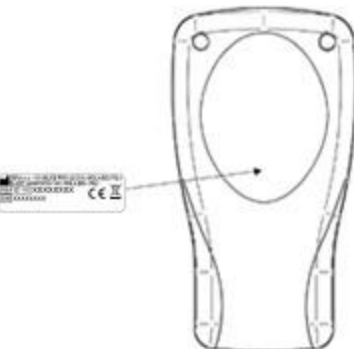

Wired handheld.

The handheld control plate is located at the centre on the back.



Plate images are purely illustrative; refer to the plate placed on the device.

14. TIMES/SENSITIVITY CHARTS

When using the x-ray unit, in conjunction with Zen-X or X-Pod, it is recommended to use the default value of sensitivity.

When using the x-ray unit, in conjunction with digital sensors (CMOS / CCD), phosphors or films, you need to find the appropriate exposure time in relation to the image that you want to obtain. Once identified this time for a specific combination of tooth and patient size, you can set the sensitivity parameter in accordance with the exposure time found (procedure described in paragraph 5.4).

	NOTE: This section applies only to models RX DC REF: MRPU*6***, MRXU*6*** (Character * can be any alphanumeric value)
---	--

Sensitivity	19*											
	20 cm (8")						30 cm (12")					
Collimator (focus-skin distance)	En60		En63		En65		En60		En63		En65	
Mode	A	B	A	B	A	B	A	B	A	B	A	B
Patient size												
Lower incisors	0.125	0.080	0.110	0.071	0.100	0.063	0.250	0.160	0.220	0.140	0.200	0.125
Lower canines/bicuspid	0.160	0.100	0.140	0.090	0.125	0.080	0.320	0.200	0.280	0.180	0.250	0.160
Upper incisors/front "bitewing"	0.160	0.100	0.140	0.090	0.125	0.080	0.320	0.200	0.280	0.180	0.250	0.160
Lower molars	0.200	0.125	0.180	0.110	0.160	0.100	0.400	0.250	0.360	0.220	0.320	0.200
Upper canines/bicuspid/rear "bitewing"	0.200	0.125	0.180	0.110	0.160	0.100	0.400	0.250	0.360	0.220	0.320	0.200
Upper molars	0.250	0.160	0.220	0.140	0.200	0.125	0.500	0.320	0.450	0.280	0.400	0.250

	NOTE: This section applies only to models RX DC REF: MRPU*7***, MRXU*7*** (Character * can be any alphanumeric value)
--	--

Sensitivity	19*											
	20 cm (8")						30 cm (12")					
Collimator (focus-skin distance)	En60		En65		En70		En60		En65		En70	
Mode	A	B	A	B	A	B	A	B	A	B	A	B
Patient size												
Lower incisors	0.110	0.071	0.080	0.050	0.063	0.040	0.220	0.140	0.160	0.100	0.140	0.080
Lower canines/bicuspid	0.140	0.090	0.100	0.063	0.080	0.056	0.280	0.180	0.200	0.125	0.160	0.110
Upper incisors/front "bitewing"	0.140	0.090	0.100	0.063	0.080	0.056	0.280	0.180	0.200	0.125	0.160	0.110
Lower molars	0.180	0.110	0.125	0.080	0.110	0.063	0.360	0.220	0.250	0.160	0.220	0.140
Upper canines/bicuspid/rear "bitewing"	0.180	0.110	0.125	0.080	0.110	0.063	0.360	0.220	0.250	0.160	0.220	0.140
Upper molars	0.220	0.140	0.160	0.100	0.140	0.080	0.450	0.280	0.320	0.200	0.280	0.160

* = Default settings

A = Adult

B = Child

15. NOMINAL DOSE EMISSION VALUES

Dose in air @ 200 mm	60 kV	63 kV	65 kV	70 kV
mGy/mAs ($\pm 40\%$)	1.22	1.33	1.41	1.59

	NOTE: This section applies only to models RX DC [REF]: *****6*** (Character * can be any alphanumeric value)
---	--

Nominal emission values according to time and type of collimator:

Collimator	Round \varnothing 60 mm					
SSD	200 mm					
A (cm ²)	28.26					
KV - mA	60kV 7mA		63kV 6mA		65kV 6mA	
t (s)	DOSE mGy	DAP mGy · cm ²	DOSE mGy	DAP mGy · cm ²	DOSE mGy	DAP mGy · cm ²
0.020	0.17	4.8	0.16	4.5	0.17	4.8
0.022	0.19	5.3	0.18	5.0	0.19	5.3
0.025	0.21	6.0	0.20	5.6	0.21	6.0
0.028	0.24	6.8	0.22	6.3	0.24	6.7
0.032	0.27	7.7	0.26	7.2	0.27	7.7
0.036	0.31	8.7	0.29	8.1	0.30	8.6
0.040	0.34	9.7	0.32	9.0	0.34	9.6
0.045	0.38	10.9	0.36	10.1	0.38	10.8
0.050	0.43	12.1	0.40	11.3	0.42	12.0
0.056	0.48	13.5	0.45	12.6	0.47	13.4
0.063	0.54	15.2	0.50	14.2	0.53	15.1
0.071	0.61	17.1	0.57	16.0	0.60	17.0
0.080	0.68	19.3	0.64	18.0	0.68	19.1
0.090	0.77	21.7	0.72	20.3	0.76	21.5
0.100	0.85	24.1	0.80	22.6	0.85	23.9
0.110	0.94	26.5	0.88	24.8	0.93	26.3
0.125	1.07	30.2	1.00	28.2	1.06	29.9
0.140	1.20	33.8	1.12	31.6	1.18	33.5
0.160	1.37	38.6	1.28	36.1	1.35	38.3
0.180	1.54	43.4	1.44	40.6	1.52	43.0
0.200	1.71	48.3	1.60	45.1	1.69	47.8
0.220	1.88	53.1	1.76	49.6	1.86	52.6
0.250	2.14	60.3	2.00	56.4	2.12	59.8
0.280	2.39	67.6	2.23	63.1	2.37	66.9
0.320	2.73	77.2	2.55	72.2	2.71	76.5
0.360	3.07	86.9	2.87	81.2	3.05	86.1
0.400	3.42	96.5	3.19	90.2	3.38	95.6
0.450	3.84	108.6	3.59	101.5	3.81	107.6
0.500	4.27	120.7	3.99	112.8	4.23	119.5
0.560	4.78	135.2	4.47	126.3	4.74	133.9
0.630	5.38	152.0	5.03	142.1	5.33	150.6
0.710	6.06	171.4	5.67	160.1	6.01	169.7
0.800	6.83	193.1	6.38	180.4	6.77	191.3
0.900	7.69	217.2	7.18	203.0	7.61	215.2
1.000	8.54	241.3	7.98	225.5	8.46	239.1



NOTE: This section applies only to models RX DC REF: *****7***
(Character * can be any alphanumeric value)

Nominal emission values according to time and type of collimator:

Collimator	Round \varnothing 60 mm					
SSD	200 mm					
A (cm ²)	28.26					
KV - mA	60kV 8mA		65kV 8mA		70kV 8mA	
t (s)	DOSE mGy	DAP mGy · cm ²	DOSE mGy	DAP mGy · cm ²	DOSE mGy	DAP mGy · cm ²
0.020	0.20	5.5	0.23	6.4	0.25	7.2
0.022	0.21	6.1	0.25	7.0	0.28	7.9
0.025	0.24	6.9	0.28	8.0	0.32	9.0
0.028	0.27	7.7	0.32	8.9	0.36	10.1
0.032	0.31	8.8	0.36	10.2	0.41	11.5
0.036	0.35	9.9	0.41	11.5	0.46	12.9
0.040	0.39	11.0	0.45	12.8	0.51	14.4
0.045	0.44	12.4	0.51	14.3	0.57	16.2
0.050	0.49	13.8	0.56	15.9	0.64	18.0
0.056	0.55	15.4	0.63	17.9	0.71	20.1
0.063	0.61	17.4	0.71	20.1	0.80	22.6
0.071	0.69	19.6	0.80	22.6	0.90	25.5
0.080	0.78	22.1	0.90	25.5	1.02	28.8
0.090	0.88	24.8	1.02	28.7	1.14	32.4
0.100	0.98	27.6	1.13	31.9	1.27	35.9
0.110	1.07	30.3	1.24	35.1	1.40	39.5
0.125	1.22	34.5	1.41	39.8	1.59	44.9
0.140	1.37	38.6	1.58	44.6	1.78	50.3
0.160	1.56	44.1	1.80	51.0	2.04	57.5
0.180	1.76	49.6	2.03	57.4	2.29	64.7
0.200	1.95	55.2	2.26	63.8	2.54	71.9
0.220	2.15	60.7	2.48	70.1	2.80	79.1
0.250	2.44	69.0	2.82	79.7	3.18	89.9
0.280	2.73	77.2	3.16	89.3	3.56	100.7
0.320	3.12	88.3	3.61	102.0	4.07	115.0
0.360	3.51	99.3	4.06	114.8	4.58	129.4
0.400	3.90	110.3	4.51	127.5	5.09	143.8
0.450	4.39	124.1	5.08	143.4	5.72	161.8
0.500	4.88	137.9	5.64	159.4	6.36	179.7
0.560	5.47	154.5	6.32	178.5	7.12	201.3
0.630	6.15	173.8	7.11	200.8	8.01	226.5
0.710	6.93	195.8	8.01	226.3	9.03	255.2
0.800	7.81	220.7	9.02	255.0	10.18	287.6
0.900	8.78	248.2	10.15	286.9	11.45	323.5
1.000	9.76	275.8	11.28	318.8	12.72	359.5



NOTE: This section applies only to models RX DC REF: *****6***
(Character * can be any alphanumeric value)

Collimator	Rectangular 35x45 mm					
SSD	30 cm					
A (cm ²)	15.75					
KV - mA	60kV 7mA		63kV 6mA		65kV 6mA	
t (s)	DOSE mGy	DAP mGy · cm ²	DOSE mGy	DAP mGy · cm ²	DOSE mGy	DAP mGy · cm ²
0.020	0.09	1.3	0.08	1.3	0.08	1.3
0.022	0.09	1.5	0.09	1.4	0.09	1.5
0.025	0.11	1.7	0.10	1.6	0.11	1.7
0.028	0.12	1.9	0.11	1.8	0.12	1.9
0.032	0.14	2.2	0.13	2.0	0.14	2.1
0.036	0.15	2.4	0.14	2.3	0.15	2.4
0.040	0.17	2.7	0.16	2.5	0.17	2.7
0.045	0.19	3.0	0.18	2.8	0.19	3.0
0.050	0.21	3.4	0.20	3.1	0.21	3.3
0.056	0.24	3.8	0.22	3.5	0.24	3.7
0.063	0.27	4.2	0.25	4.0	0.27	4.2
0.071	0.30	4.8	0.28	4.5	0.30	4.7
0.080	0.34	5.4	0.32	5.0	0.34	5.3
0.090	0.38	6.1	0.36	5.7	0.38	6.0
0.100	0.43	6.7	0.40	6.3	0.42	6.7
0.110	0.47	7.4	0.44	6.9	0.47	7.3
0.125	0.53	8.4	0.50	7.9	0.53	8.3
0.140	0.60	9.4	0.56	8.8	0.59	9.3
0.160	0.68	10.8	0.64	10.1	0.68	10.7
0.180	0.77	12.1	0.72	11.3	0.76	12.0
0.200	0.85	13.5	0.80	12.6	0.85	13.3
0.220	0.94	14.8	0.88	13.8	0.93	14.7
0.250	1.07	16.8	1.00	15.7	1.06	16.7
0.280	1.20	18.8	1.12	17.6	1.18	18.7
0.320	1.37	21.5	1.28	20.1	1.35	21.3
0.360	1.54	24.2	1.44	22.6	1.52	24.0
0.400	1.71	26.9	1.60	25.1	1.69	26.6
0.450	1.92	30.3	1.80	28.3	1.90	30.0
0.500	2.14	33.6	2.00	31.4	2.12	33.3
0.560	2.39	37.7	2.23	35.2	2.37	37.3
0.630	2.69	42.4	2.51	39.6	2.66	42.0
0.710	3.03	47.7	2.83	44.6	3.00	47.3
0.800	3.42	53.8	3.19	50.3	3.38	53.3
0.900	3.84	60.5	3.59	56.6	3.81	60.0
1.000	4.27	67.3	3.99	62.8	4.23	66.6



NOTE: This section applies only to models RX DC REF: *****7***
 (Character * can be any alphanumeric value)

Collimator	Rectangular 35x45 mm					
SSD	30 cm					
A (cm ²)	15.75					
KV - mA	60kV 8mA		65kV 8mA		70kV 8mA	
t (s)	DOSE mGy	DAP mGy · cm ²	DOSE mGy	DAP mGy · cm ²	DOSE mGy	DAP mGy · cm ²
0.020	0.10	1.5	0.11	1.8	0.13	2.0
0.022	0.11	1.7	0.12	2.0	0.14	2.2
0.025	0.12	1.9	0.14	2.2	0.16	2.5
0.028	0.14	2.2	0.16	2.5	0.18	2.8
0.032	0.16	2.5	0.18	2.8	0.20	3.2
0.036	0.18	2.8	0.20	3.2	0.23	3.6
0.040	0.20	3.1	0.23	3.6	0.25	4.0
0.045	0.22	3.5	0.25	4.0	0.29	4.5
0.050	0.24	3.8	0.28	4.4	0.32	5.0
0.056	0.27	4.3	0.32	5.0	0.36	5.6
0.063	0.31	4.8	0.36	5.6	0.40	6.3
0.071	0.35	5.5	0.40	6.3	0.45	7.1
0.080	0.39	6.1	0.45	7.1	0.51	8.0
0.090	0.44	6.9	0.51	8.0	0.57	9.0
0.100	0.49	7.7	0.56	8.9	0.64	10.0
0.110	0.54	8.5	0.62	9.8	0.70	11.0
0.125	0.61	9.6	0.71	11.1	0.80	12.5
0.140	0.68	10.8	0.79	12.4	0.89	14.0
0.160	0.78	12.3	0.90	14.2	1.02	16.0
0.180	0.88	13.8	1.02	16.0	1.14	18.0
0.200	0.98	15.4	1.13	17.8	1.27	20.0
0.220	1.07	16.9	1.24	19.5	1.40	22.0
0.250	1.22	19.2	1.41	22.2	1.59	25.0
0.280	1.37	21.5	1.58	24.9	1.78	28.0
0.320	1.56	24.6	1.80	28.4	2.04	32.1
0.360	1.76	27.7	2.03	32.0	2.29	36.1
0.400	1.95	30.7	2.26	35.5	2.54	40.1
0.450	2.20	34.6	2.54	40.0	2.86	45.1
0.500	2.44	38.4	2.82	44.4	3.18	50.1
0.560	2.73	43.0	3.16	49.7	3.56	56.1
0.630	3.07	48.4	3.55	56.0	4.01	63.1
0.710	3.46	54.6	4.00	63.1	4.52	71.1
0.800	3.90	61.5	4.51	71.1	5.09	80.1
0.900	4.39	69.2	5.08	79.9	5.72	90.2
1.000	4.88	76.9	5.64	88.8	6.36	100.2



NOTE: This section applies only to models RX DC REF: *****6***
(Character * can be any alphanumeric value)

Collimator	Round \varnothing 55 mm					
SSD	30 cm					
A (cm ²)	23.75					
KV - mA	60kV 7mA		63kV 6mA		65kV 6mA	
t (s)	DOSE mGy	DAP mGy · cm ²	DOSE mGy	DAP mGy · cm ²	DOSE mGy	DAP mGy · cm ²
0.020	0.09	2.0	0.08	1.9	0.08	2.0
0.022	0.09	2.2	0.09	2.1	0.09	2.2
0.025	0.11	2.5	0.10	2.4	0.11	2.5
0.028	0.12	2.8	0.11	2.7	0.12	2.8
0.032	0.14	3.2	0.13	3.0	0.14	3.2
0.036	0.15	3.7	0.14	3.4	0.15	3.6
0.040	0.17	4.1	0.16	3.8	0.17	4.0
0.045	0.19	4.6	0.18	4.3	0.19	4.5
0.050	0.21	5.1	0.20	4.7	0.21	5.0
0.056	0.24	5.7	0.22	5.3	0.24	5.6
0.063	0.27	6.4	0.25	6.0	0.27	6.3
0.071	0.30	7.2	0.28	6.7	0.30	7.1
0.080	0.34	8.1	0.32	7.6	0.34	8.0
0.090	0.38	9.1	0.36	8.5	0.38	9.0
0.100	0.43	10.1	0.40	9.5	0.42	10.0
0.110	0.47	11.2	0.44	10.4	0.47	11.1
0.125	0.53	12.7	0.50	11.8	0.53	12.6
0.140	0.60	14.2	0.56	13.3	0.59	14.1
0.160	0.68	16.2	0.64	15.2	0.68	16.1
0.180	0.77	18.3	0.72	17.1	0.76	18.1
0.200	0.85	20.3	0.80	19.0	0.85	20.1
0.220	0.94	22.3	0.88	20.8	0.93	22.1
0.250	1.07	25.4	1.00	23.7	1.06	25.1
0.280	1.20	28.4	1.12	26.5	1.18	28.1
0.320	1.37	32.5	1.28	30.3	1.35	32.1
0.360	1.54	36.5	1.44	34.1	1.52	36.2
0.400	1.71	40.6	1.60	37.9	1.69	40.2
0.450	1.92	45.6	1.80	42.6	1.90	45.2
0.500	2.14	50.7	2.00	47.4	2.12	50.2
0.560	2.39	56.8	2.23	53.1	2.37	56.3
0.630	2.69	63.9	2.51	59.7	2.66	63.3
0.710	3.03	72.0	2.83	67.3	3.00	71.3
0.800	3.42	81.1	3.19	75.8	3.38	80.4
0.900	3.84	91.3	3.59	85.3	3.81	90.4
1.000	4.27	101.4	3.99	94.8	4.23	100.5



NOTE: This section applies only to models RX DC REF: *****7***
(Character * can be any alphanumeric value)

Collimator	Round \varnothing 55 mm					
SSD	30 cm					
A (cm ²)	23.75					
KV - mA	60kV 8mA		65kV 8mA		70kV 8mA	
t (s)	DOSE mGy	DAP mGy · cm ²	DOSE mGy	DAP mGy · cm ²	DOSE mGy	DAP mGy · cm ²
0.020	0.10	2.3	0.11	2.7	0.13	3.0
0.022	0.11	2.5	0.12	2.9	0.14	3.3
0.025	0.12	2.9	0.14	3.3	0.16	3.8
0.028	0.14	3.2	0.16	3.8	0.18	4.2
0.032	0.16	3.7	0.18	4.3	0.20	4.8
0.036	0.18	4.2	0.20	4.8	0.23	5.4
0.040	0.20	4.6	0.23	5.4	0.25	6.0
0.045	0.22	5.2	0.25	6.0	0.29	6.8
0.050	0.24	5.8	0.28	6.7	0.32	7.6
0.056	0.27	6.5	0.32	7.5	0.36	8.5
0.063	0.31	7.3	0.36	8.4	0.40	9.5
0.071	0.35	8.2	0.40	9.5	0.45	10.7
0.080	0.39	9.3	0.45	10.7	0.51	12.1
0.090	0.44	10.4	0.51	12.1	0.57	13.6
0.100	0.49	11.6	0.56	13.4	0.64	15.1
0.110	0.54	12.7	0.62	14.7	0.70	16.6
0.125	0.61	14.5	0.71	16.7	0.80	18.9
0.140	0.68	16.2	0.79	18.8	0.89	21.1
0.160	0.78	18.5	0.90	21.4	1.02	24.2
0.180	0.88	20.9	1.02	24.1	1.14	27.2
0.200	0.98	23.2	1.13	26.8	1.27	30.2
0.220	1.07	25.5	1.24	29.5	1.40	33.2
0.250	1.22	29.0	1.41	33.5	1.59	37.8
0.280	1.37	32.5	1.58	37.5	1.78	42.3
0.320	1.56	37.1	1.80	42.9	2.04	48.3
0.360	1.76	41.7	2.03	48.2	2.29	54.4
0.400	1.95	46.4	2.26	53.6	2.54	60.4
0.450	2.20	52.2	2.54	60.3	2.86	68.0
0.500	2.44	58.0	2.82	67.0	3.18	75.5
0.560	2.73	64.9	3.16	75.0	3.56	84.6
0.630	3.07	73.0	3.55	84.4	4.01	95.2
0.710	3.46	82.3	4.00	95.1	4.52	107.2
0.800	3.90	92.7	4.51	107.2	5.09	120.8
0.900	4.39	104.3	5.08	120.6	5.72	135.9
1.000	4.88	115.9	5.64	134.0	6.36	151.1



NOTE: This section applies only to models RX DC REF: *****6***
(Character * can be any alphanumeric value)

Collimator	Rectangular 22x35 mm					
SSD	31 cm					
A (cm ²)	7.70					
KV - mA	60kV 7mA		63kV 6mA		65kV 6mA	
t (s)	DOSE mGy	DAP mGy · cm ²	DOSE mGy	DAP mGy · cm ²	DOSE mGy	DAP mGy · cm ²
0.020	0.09	0.7	0.08	0.6	0.08	0.7
0.022	0.09	0.7	0.09	0.7	0.09	0.7
0.025	0.11	0.8	0.10	0.8	0.11	0.8
0.028	0.12	0.9	0.11	0.9	0.12	0.9
0.032	0.14	1.1	0.13	1.0	0.14	1.0
0.036	0.15	1.2	0.14	1.1	0.15	1.2
0.040	0.17	1.3	0.16	1.2	0.17	1.3
0.045	0.19	1.5	0.18	1.4	0.19	1.5
0.050	0.21	1.6	0.20	1.5	0.21	1.6
0.056	0.24	1.8	0.22	1.7	0.24	1.8
0.063	0.27	2.1	0.25	1.9	0.27	2.1
0.071	0.30	2.3	0.28	2.2	0.30	2.3
0.080	0.34	2.6	0.32	2.5	0.34	2.6
0.090	0.38	3.0	0.36	2.8	0.38	2.9
0.100	0.43	3.3	0.40	3.1	0.42	3.3
0.110	0.47	3.6	0.44	3.4	0.47	3.6
0.125	0.53	4.1	0.50	3.8	0.53	4.1
0.140	0.60	4.6	0.56	4.3	0.59	4.6
0.160	0.68	5.3	0.64	4.9	0.68	5.2
0.180	0.77	5.9	0.72	5.5	0.76	5.9
0.200	0.85	6.6	0.80	6.1	0.85	6.5
0.220	0.94	7.2	0.88	6.8	0.93	7.2
0.250	1.07	8.2	1.00	7.7	1.06	8.1
0.280	1.20	9.2	1.12	8.6	1.18	9.1
0.320	1.37	10.5	1.28	9.8	1.35	10.4
0.360	1.54	11.8	1.44	11.1	1.52	11.7
0.400	1.71	13.2	1.60	12.3	1.69	13.0
0.450	1.92	14.8	1.80	13.8	1.90	14.7
0.500	2.14	16.4	2.00	15.4	2.12	16.3
0.560	2.39	18.4	2.23	17.2	2.37	18.2
0.630	2.69	20.7	2.51	19.4	2.66	20.5
0.710	3.03	23.3	2.83	21.8	3.00	23.1
0.800	3.42	26.3	3.19	24.6	3.38	26.1
0.900	3.84	29.6	3.59	27.7	3.81	29.3
1.000	4.27	32.9	3.99	30.7	4.23	32.6



NOTE: This section applies only to models RX DC REF: *****7***
(Character * can be any alphanumeric value)

Collimator	Rectangular 22x35 mm					
SSD	31 cm					
A (cm ²)	7.70					
KV - mA	60kV 8mA		65kV 8mA		70kV 8mA	
t (s)	DOSE mGy	DAP mGy · cm ²	DOSE mGy	DAP mGy · cm ²	DOSE mGy	DAP mGy · cm ²
0.020	0.10	0.8	0.11	0.9	0.13	1.0
0.022	0.11	0.8	0.12	1.0	0.14	1.1
0.025	0.12	0.9	0.14	1.1	0.16	1.2
0.028	0.14	1.1	0.16	1.2	0.18	1.4
0.032	0.16	1.2	0.18	1.4	0.20	1.6
0.036	0.18	1.4	0.20	1.6	0.23	1.8
0.040	0.20	1.5	0.23	1.7	0.25	2.0
0.045	0.22	1.7	0.25	2.0	0.29	2.2
0.050	0.24	1.9	0.28	2.2	0.32	2.4
0.056	0.27	2.1	0.32	2.4	0.36	2.7
0.063	0.31	2.4	0.36	2.7	0.40	3.1
0.071	0.35	2.7	0.40	3.1	0.45	3.5
0.080	0.39	3.0	0.45	3.5	0.51	3.9
0.090	0.44	3.4	0.51	3.9	0.57	4.4
0.100	0.49	3.8	0.56	4.3	0.64	4.9
0.110	0.54	4.1	0.62	4.8	0.70	5.4
0.125	0.61	4.7	0.71	5.4	0.80	6.1
0.140	0.68	5.3	0.79	6.1	0.89	6.9
0.160	0.78	6.0	0.90	6.9	1.02	7.8
0.180	0.88	6.8	1.02	7.8	1.14	8.8
0.200	0.98	7.5	1.13	8.7	1.27	9.8
0.220	1.07	8.3	1.24	9.6	1.40	10.8
0.250	1.22	9.4	1.41	10.9	1.59	12.2
0.280	1.37	10.5	1.58	12.2	1.78	13.7
0.320	1.56	12.0	1.80	13.9	2.04	15.7
0.360	1.76	13.5	2.03	15.6	2.29	17.6
0.400	1.95	15.0	2.26	17.4	2.54	19.6
0.450	2.20	16.9	2.54	19.5	2.86	22.0
0.500	2.44	18.8	2.82	21.7	3.18	24.5
0.560	2.73	21.0	3.16	24.3	3.56	27.4
0.630	3.07	23.7	3.55	27.4	4.01	30.9
0.710	3.46	26.7	4.00	30.8	4.52	34.8
0.800	3.90	30.1	4.51	34.7	5.09	39.2
0.900	4.39	33.8	5.08	39.1	5.72	44.1
1.000	4.88	37.6	5.64	43.4	6.36	49.0



NOTE: This section applies only to models RX DC REF: *****6***
(Character * can be any alphanumeric value)

Collimator	Rectangular 31x41 mm					
SSD	31 cm					
A (cm ²)	12.71					
KV - mA	60kV 7mA		63kV 6mA		65kV 6mA	
t (s)	DOSE mGy	DAP mGy · cm ²	DOSE mGy	DAP mGy · cm ²	DOSE mGy	DAP mGy · cm ²
0.020	0.09	1.1	0.08	1.0	0.08	1.1
0.022	0.09	1.2	0.09	1.1	0.09	1.2
0.025	0.11	1.4	0.10	1.3	0.11	1.3
0.028	0.12	1.5	0.11	1.4	0.12	1.5
0.032	0.14	1.7	0.13	1.6	0.14	1.7
0.036	0.15	2.0	0.14	1.8	0.15	1.9
0.040	0.17	2.2	0.16	2.0	0.17	2.2
0.045	0.19	2.4	0.18	2.3	0.19	2.4
0.050	0.21	2.7	0.20	2.5	0.21	2.7
0.056	0.24	3.0	0.22	2.8	0.24	3.0
0.063	0.27	3.4	0.25	3.2	0.27	3.4
0.071	0.30	3.9	0.28	3.6	0.30	3.8
0.080	0.34	4.3	0.32	4.1	0.34	4.3
0.090	0.38	4.9	0.36	4.6	0.38	4.8
0.100	0.43	5.4	0.40	5.1	0.42	5.4
0.110	0.47	6.0	0.44	5.6	0.47	5.9
0.125	0.53	6.8	0.50	6.3	0.53	6.7
0.140	0.60	7.6	0.56	7.1	0.59	7.5
0.160	0.68	8.7	0.64	8.1	0.68	8.6
0.180	0.77	9.8	0.72	9.1	0.76	9.7
0.200	0.85	10.9	0.80	10.1	0.85	10.8
0.220	0.94	11.9	0.88	11.2	0.93	11.8
0.250	1.07	13.6	1.00	12.7	1.06	13.4
0.280	1.20	15.2	1.12	14.2	1.18	15.1
0.320	1.37	17.4	1.28	16.2	1.35	17.2
0.360	1.54	19.5	1.44	18.3	1.52	19.4
0.400	1.71	21.7	1.60	20.3	1.69	21.5
0.450	1.92	24.4	1.80	22.8	1.90	24.2
0.500	2.14	27.1	2.00	25.4	2.12	26.9
0.560	2.39	30.4	2.23	28.4	2.37	30.1
0.630	2.69	34.2	2.51	31.9	2.66	33.9
0.710	3.03	38.5	2.83	36.0	3.00	38.2
0.800	3.42	43.4	3.19	40.6	3.38	43.0
0.900	3.84	48.8	3.59	45.6	3.81	48.4
1.000	4.27	54.3	3.99	50.7	4.23	53.8



NOTE: This section applies only to models RX DC REF: *****7***
(Character * can be any alphanumeric value)

Collimator	Rectangular 31x41 mm					
SSD	31 cm					
A (cm ²)	12.71					
KV - mA	60kV 8mA		65kV 8mA		70kV 8mA	
t (s)	DOSE mGy	DAP mGy · cm ²	DOSE mGy	DAP mGy · cm ²	DOSE mGy	DAP mGy · cm ²
0.020	0.10	1.2	0.11	1.4	0.13	1.6
0.022	0.11	1.4	0.12	1.6	0.14	1.8
0.025	0.12	1.6	0.14	1.8	0.16	2.0
0.028	0.14	1.7	0.16	2.0	0.18	2.3
0.032	0.16	2.0	0.18	2.3	0.20	2.6
0.036	0.18	2.2	0.20	2.6	0.23	2.9
0.040	0.20	2.5	0.23	2.9	0.25	3.2
0.045	0.22	2.8	0.25	3.2	0.29	3.6
0.050	0.24	3.1	0.28	3.6	0.32	4.0
0.056	0.27	3.5	0.32	4.0	0.36	4.5
0.063	0.31	3.9	0.36	4.5	0.40	5.1
0.071	0.35	4.4	0.40	5.1	0.45	5.7
0.080	0.39	5.0	0.45	5.7	0.51	6.5
0.090	0.44	5.6	0.51	6.5	0.57	7.3
0.100	0.49	6.2	0.56	7.2	0.64	8.1
0.110	0.54	6.8	0.62	7.9	0.70	8.9
0.125	0.61	7.8	0.71	9.0	0.80	10.1
0.140	0.68	8.7	0.79	10.0	0.89	11.3
0.160	0.78	9.9	0.90	11.5	1.02	12.9
0.180	0.88	11.2	1.02	12.9	1.14	14.6
0.200	0.98	12.4	1.13	14.3	1.27	16.2
0.220	1.07	13.6	1.24	15.8	1.40	17.8
0.250	1.22	15.5	1.41	17.9	1.59	20.2
0.280	1.37	17.4	1.58	20.1	1.78	22.6
0.320	1.56	19.8	1.80	22.9	2.04	25.9
0.360	1.76	22.3	2.03	25.8	2.29	29.1
0.400	1.95	24.8	2.26	28.7	2.54	32.3
0.450	2.20	27.9	2.54	32.3	2.86	36.4
0.500	2.44	31.0	2.82	35.8	3.18	40.4
0.560	2.73	34.7	3.16	40.1	3.56	45.3
0.630	3.07	39.1	3.55	45.2	4.01	50.9
0.710	3.46	44.0	4.00	50.9	4.52	57.4
0.800	3.90	49.6	4.51	57.3	5.09	64.7
0.900	4.39	55.8	5.08	64.5	5.72	72.8
1.000	4.88	62.0	5.64	71.7	6.36	80.8



An indirect measure of the DAP can be obtained by a measuring instrument of the absorbed dose. In this case, the DAP is obtained by multiplying the dose measurement for the irradiated area. The data obtained by this measurement has a tolerance of not less than 20%.

16. INSPECTION AND MAINTENANCE

16.1.USER INSPECTION

These instructions describe the maintenance procedures for the x-ray unit.

These instructions apply to all versions of said equipment, as well as all the accessories that may have been provided, therefore the description of some parts may not correspond to your equipment.

Inspection and preventive maintenance must be performed at scheduled intervals to protect the health and safety of patients, users and other persons in accordance with national regulations regarding the use and maintenance of dental x-ray units that are in force in the country where the device is installed.

In order to ensure the operational safety and functional reliability of your product, the system owner should check the equipment at regular intervals (at least once a year) or commission an authorised technician to do so.

If one or more checks to be performed are not satisfactory, please contact your dealer for technical support.

Step	Description	Reference in User Manual	Answer questions with yes (✓) or not (-)				
			Inspection DATE				
			__/__/20__	__/__/20__	__/__/20__	__/__/20__	__/__/20__
1	Check that all labels located - on the wall-mounted cover, - on the x-ray tube - inside the collimator/s, are intact, correctly applied and readable.	Section Identification nameplates					
2	Check there are no external damages to the equipment, which may reduce protection against radiation.	Section Description of the x-ray unit					
3	Check the battery level of the wireless remote control.	Section Batteries and charge level indication					
4	Check the remote control functionality: buttons must respond to interaction	Section Control Panel					
5	Check the power switch verifying that the switch is working properly and the main switch green light switches on when the switch is in the ON position.	Section Turning the x-ray unit on and off					
6	Check the electromechanical brake that lock/unlock the movement of the generator – ball joint model units only	Section Ball joint technology					
7	Check proper functioning of x-ray generator indicator light – ball joint model units only	Section X-ray generator indicator light					
8	Check the exposure buzzer during a trial x-rays emission	Section Performing the exposure					
9	Verify that exposure is immediately interrupted when x-ray button is released	Section Performing the exposure					
10	Check the scissors arm balance	Section Description of the x-ray unit					
11	Verify that exposure is immediately interrupted when x-ray button is released	Section Performing the exposure					
12	Check the x-ray generator functionality performing a complete trial exposure. Select any exposure time and hold down the emission button throughout the entire exam procedure. Absence of error messages assures proper generator functionality.	Section Using the x-ray unit					

Operator Name					
Signature					

The undersigned confirms that the equipment was checked for the above criteria and that, in case of any malfunction, an authorised technician of the local dealer was informed.

 All inspection and maintenance work performed by the system owner and/or service engineer must be recorded in this document and kept near the unit!

16.2. TECHNICAL MAINTENANCE

These instructions describe the maintenance procedures for the x-ray unit. These instructions apply to all versions of said equipment.

In order to ensure the operational safety and functional reliability of the equipment installed, **at least once** a year an authorised service technician must perform a full inspection of the device.

When taking measurements that require a multimeter, always use a calibrated digital multimeter.

All the following tests will be carried out. Customer should be notified prior to replacing any parts.

Step	Description	Reference in User Manual	Answer questions with yes (√) or not (-)				
			Inspection DATE				
			__/__/20__	__/__/20__	__/__/20__	__/__/20__	__/__/20__
1	Check that all labels located - on the wall-mounted cover, - on the x-ray tube - inside the collimator/s, are intact, correctly applied and readable.	User Manual, Section Identification nameplates					
2	Check there are no external damages to the equipment, which may reduce protection against radiation.	User Manual, Section Description of the x-ray unit					
3	Pull out the collimator and panel stop ring, take off the screw cover caps and loosen the screws that secure the lower cover. Check there is no oil leakage on the tube-head.	Technical Manual, Section X-ray head					
4	Check the electromechanical brake that locks/unlocks the movement of the generator and adjust it if necessary – ball joint model units only	Technical Manual, Section Actuator unit					
5	Power off the unit and remove the wall mounting cover. Disconnect the unit from the main power supply and check the condition of the main power supply cable. Replace it in case of damage. Connect it back making sure the safety ground is securely connected. Install the wall-mounted cover back again.	Technical Manual, Section Wall-mounted plate wiring connections					
6	Check the battery level of the wireless remote control.	User Manual, Section Batteries and charge level indication					
7	Check the remote control functionality: buttons must respond to interaction	User Manual, Section Control Panel					
8	Check the power switch verifying that the switch is working properly and the main switch green light switches on when the switch is in the ON position.	Section Turning the x-ray unit on and off					
9	Check proper functioning of x-ray generator indicator light – ball joint model units only	User Manual, Section X-ray generator indicator light					
10	Check the exposure buzzer during a trial x-rays emission	User Manual, Section Performing the exposure					
11	Verify that exposure is immediately interrupted when x-ray button is released	Section Performing the exposure					
12	Check the scissors arm balance and adjust it if necessary	Technical Manual, Section Balancing the double pantograph arm					
13	Perform a calibration of the x-ray tube housing	Technical Manual, Section Calibrating the x-ray head					

Operator Name					
Signature					

The undersigned confirms that the equipment was checked for the above criteria and that it was provided in optimal operating conditions.



All inspection and maintenance work performed by the system owner and/or service engineer must be recorded in this document and kept near the unit!